

ALPHA®

TOOLS FOR

HARDSCAPE CONTRACTORS

CUTTING, PROFILING & POLISHING



35TH

ANNIVERSARY

Since 1986

*Celebrating 35 Years
Providing Better Solutions to the Professional*



VERSION 6

Yes... We have Moved!

Find us at our new location here:





W E L C O M E

Alpha Professional Tools® was founded in 1986 and has become a leading manufacturer of quality tools for professionals in the natural/engineered stone, porcelain, ceramic, glass, construction, marine and automotive industries. Alpha® provides the best products for cutting, drilling, shaping and polishing all types of materials.

In addition to providing the best products in the industry, Alpha Professional Tools® offers a variety of services to support their products.

Company Contact Information:

Headquarters & Training Center:	16 Park Dr Ste 9 Franklin, NJ 07416
Hours of Operation (EST):	8:30 a.m. - 5:00 p.m.
Telephone No:	201-337-3343
Toll-Free No:	800-648-7229
Fax No:	201-337-2216
Toll Free Fax No:	800-286-0114

E-mail Orders to:

orderdesk@alpha-tools.com
tooldesk@alpha-tools.com

Contact Us:

www.alpha-tools.com
info@alpha-tools.com

Follow Us:

Sales Contacts by Territory – sales@alpha-tools.com

Caribbean	201-337-3343	Ohio Valley	440-364-3759
Canada	519-546-9861	Pacific	800-648-7229
International	201-337-3343	South	480-848-6808
Midwest	630-849-7105	Southeast	678-977-1147
Northeast	973-830-7681	Southern CA	925-428-1292
Northern CA	925-428-1292		

TABLE OF CONTENTS

TOOLS

STONE CUTTER

• ESC-125, 5" Wet/Dry Stone Cutter	6
• ESC-125, 5" Countertop Trim Kit	8
• ESC-150, 6" Wet/Dry Stone Cutter	9
• ESC-150, 6" Miter Cutting Kit.....	11
• ESC-150, 6" Countertop Trim Kit	12
• ECC-125, Virtually Dust-Free Cutting Solution	13
• ECC-KIT, Dry Porcelain Paver Tile Cutting System.....	14

POLISHERS

• AIR-680UW, High-Performance Underwater Pneumatic Polisher	15
PlasterKing Resin Polishing Pads	16
• VDP-700, Variable Speed Rotary Polisher	17
Wool Pads	19
Rotary Backer Pads	19
• VSP-320, Variable Speed Wet Polisher.....	20

POLISHING KITS

• Paver Tile Bullnose Kit.....	21
• Pool Coping Kit	22
• Wet Polishing and Sanding Kit.....	51

CUTTING

DRY BLADES

• Plus	23
• Quad	24
• Eclipse II	24
• Eclipse Q.....	25
• Katana	25
• Ultracut GPM	26

WET BLADES

• Q-Cut	27
• Porcellana.....	28
• Porcellana PRS.....	28
• Vetro.....	29
• Vetro PRS	29

FLUSH CUTTING BLADES

• Vortex for Granite.....	30
• Vortex for Marble.....	30
• Ultracut APR	31

CURVE CUTTING BLADES

• Contour for Porcelain/Crystallized Glass.....	32
• Contour for Granite.....	33

CHANNEL CUTTING BLADES

• Hot-Rod Blade.....	34
----------------------	----

BLADES FOR ENGINE CUTTER

• PT Cutter	35
• Blade Master.....	36
• Rescue Blade.....	36

BLADE ACCESSORIES

• Quad Adapters	37
• Flange Adapters.....	37
• Spike Ruler	37
• Dressing Stick.....	37

PROFILING

PROFILERS

• Profiler B-Series.....	38
• Profiler Z-Series.....	38
• Profiler V-Series.....	39

GRINDING & SANDING

• Spike Disc.....	40
-------------------	----

DRILLING

CORE DRILL BITS

• Wet Core Bits.....	41
• Dry Core Bits.....	41

TRIMMER BITS

• Vacuum Brazed Trimmer Bit	42
-----------------------------------	----

DRILL BITS

• Electroplated Drill Bits.....	42
---------------------------------	----

DRILL BIT ACCESSORIES

• Drill Bit Guide.....	43
------------------------	----

POLISHING

DIAMOND PADS

• Diamond Hand Pads.....	44
• Ceramica EX.....	45
• Sandpaper	45

POLISHING WHEELS

Antique Brush Wheels.....	46
---------------------------	----

ACCESSORIES

DUST-FREE GUARDS

• Ecoguard C.....	47
• Ecoguard D.....	47
• Ecoguard CD.....	48
• Ecoguard G / G7.....	48
• Ecoguard W5 / W6 / W9	49

BACKER PADS

• Rigid Backer Pads	50
• Flexible Backer Pads.....	50
• GV Backer Pads	50

MISCELLANEOUS

• Wet Blade Cutting Kit.....	51
• Aprons.....	53
• Dust Carriage.....	55
• Gloss Checker	55
• Safety Glasses.....	55
• Ground Fault Circuit Interrupter	55
• EZ Click2 Leveling System	56
• G-Tape	57
• RSR-2000 Stain Removers.....	62

STONE CUTTER

Introducing A New and Improved
Version of Our Popular **AWS-125...**

ALPHA[®]

ESC-125

5" WET/DRY STONE CUTTER

OSHA[®]
COMPATIBLE

DRY

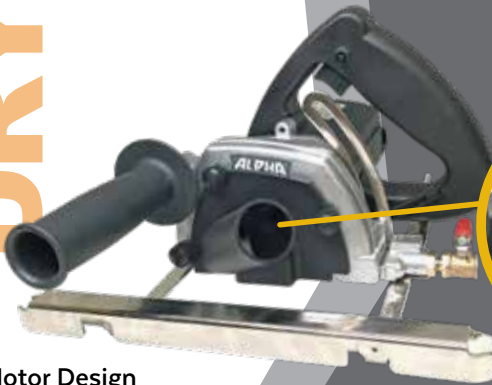

Dust Cover For HEPA
Vacuum Connection

- New Motor Design
- Kink Free Hybrid Water Supply Hose with Quick Change Connector

WET



Newly Designed
Water Jet

*Blade not included

Quick Change
Connector



GUIDE RAIL



(optional)

ASC-5CSM

STONE CUTTER

ESC-125

5" WET/DRY STONE CUTTER



- Precision Cuts Everytime
- Powerful Motor For Use On Porcelain Paver Tile, Granite, Quartz Surfaces, Marble, Limestone, Concrete and Sintered Slabs
- Water-Feed Supply Eliminates The Harmful Dust Particles
- Base Plate Allows Guides To Be Used in Multiple Ways
- Dust Cover for HEPA Vacuum Connection
- New Clamping System Ensures Cutting Stability
- Included Self-Stick Felt Strips Protects The Work Surface From Scratches
- Built-In GFCI (Ground Fault Circuit Interrupter)
- Great For Use With Curve Cutting Blades
- One Year Warranty (*See manual for details*)

SPECIFICATION	DATA
Model	ESC-125
Rating	110 Volts
Amperage	11.2A
Power	1200W
No Load Speed (min-1)	12,000 RPM
Weight	8.9 lbs (4.0 kgs)
Arbor	7/8" (22.23mm)
Cutting Disc Diameter	5" (125mm)
Plug Type	A (110V)
Cord	15ft (4.5m) Single-Phase
Max. Cutting Depth	1-5/8" (41mm)

ITEM	QUANTITY
Dust Cover	1
Knob Bolt	3
TT Ruler Guide	1
Water Hose Assembly	1
Quick Connect Adapter	1
Side Handle	1
Screw (M6x30-Left)	1
Flange 3	1
Carbon Brush Set	1
T-Handle Wrench	1
Open-End Wrench (22mm)	1
Self-stick Felt Strip Set	1
GFCI	1
EasyOn-EasyOff Sleeve	1
SS Flat Head Screw (M4x10)	3
Water Valve Assembly	1

PART NO.	SIZE	TYPE	ARBOR(S)	DESCRIPTION
ESC-125	5"	110V	7/8" (22.23mm)	Wet/Dry Stone Cutter

CUTTING KIT

ESC-125 COUNTERTOP TRIM KIT

COMPLETE TRIM KIT FOR A CUSTOM-LOOK

Part number: 5480-4150



5" COUNTERTOP TRIM KIT



Complete Trim Kit for a Custom Look

- INCLUDES:**
- Wet/Dry Stone Cutter
ESC-125
 - 5" Eclipse Blade
DEE005
 - 5" Carriage Assembly
for Stone Cutter
ASC-5CSM
 - 4' Guide Rail with Clamps
ASC-GR04
 - Surface Protection Tape
BAB0650

- Recommended for Hard Surfaces
- Eclipse II Blade has 8mm Tall Diamond Layer for a Long Life
- Perfect for your Stone Tile Application
- High-End General Purpose Turbo Blade for Stone Fabricators
- Consistent Performance without Chipping
- Kit Contains: ESC-125 Stone Cutter, 5" Carriage Assembly, 5" Eclipse II Blade and 4' Guide Rail
- One Year Tool Warranty (*See manual for details*)

PART NO.	DESCRIPTION
5480-4150	Countertop Trim Kit (ESC-125)

ESC-150

6" WET/DRY STONE CUTTER

ELECTRIC STONE CUTTER FOR INDUSTRIAL APPLICATIONS

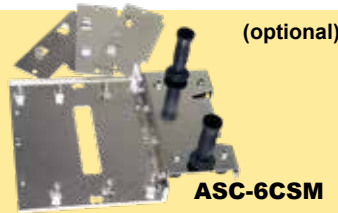
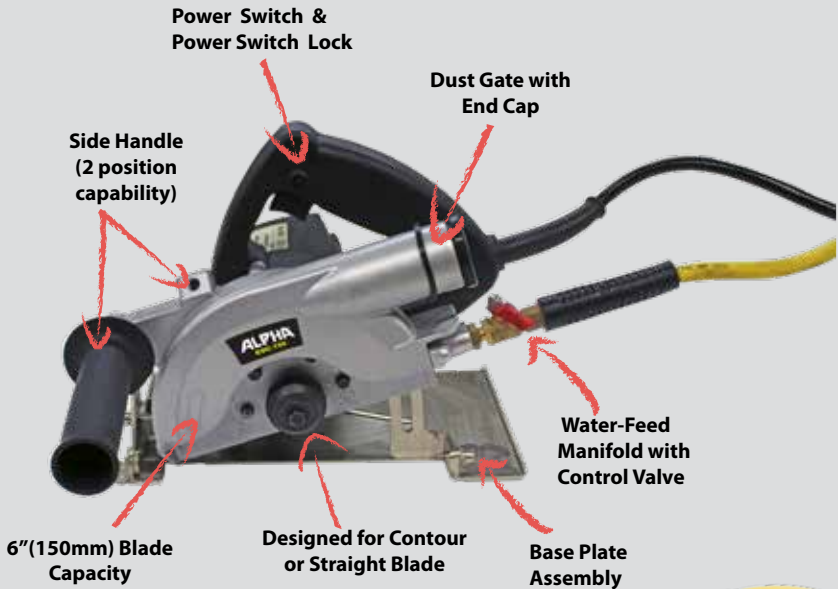

STONE CUTTER

ESC-150

6" WET/DRY STONE CUTTER



- Powerful Motor For Use On Granite, Quartz Surfaces, Marble, Limestone, Concrete & Sintered/Porcelain Slabs
- Capable of Miter Cutting 1-1/4" (3cm) Material w/Ease
- Kink-Free Water Hose for Easy Maneuverability and Reducing Operator Fatigue
- Great For Sink-Hole Cutting, Groove Cutting/ Rodding
- Comes with A Built in Dust Gate for Dustless Cutting When Connected to A HEPA Vacuum
- Miter Cutting Kit available with ESC-150/ESC-250
- One Year Tool Warranty* (*See manual for details)

SPECIFICATION	DATA
Model	ESC-150/ESC-250
Rating	110/220 Volts
Amperage	11.2A /5.5A
Power	1200W
No Load Speed (min-1)	10,000 RPM
Weight	11.30 lbs (5.12 kgs)
Arbor	7/8" (22.23mm)
Cutting Disc Diameter	6" (150mm)
Max. Cutting Depth	2" (50.88mm)
Cord	15ft (4.5m)Single-Phase
Plug Type	A (110V) / C (220V)

ITEM	QUANTITY
Side Handle	1
Screw (M6x30-Left)	1
Flange 3	1
Water Hose Assembly (15ft/4.5m)	1
Water Quick Coupler w/Shut-off Valve	1
Carbon Brush Set	1
Water Valve Assembly	1
SS Flat Head Screw (M4x10)	3
Ground Fault Circuit Interrupter	1
End Cap	1
T-Handle Wrench	1
Open-End Wrench (17mm)	1
Easy On-Easy Off Sleeve	1
Self-stick Felt Strip Set	1
Hex. Wrench (5mm)	1

PART NO.	SIZE	MAXIMUM RPM	TYPE	ARBOR(S)	DESCRIPTION
ESC-150	6"	10,000	110V	7/8" (22.23mm)	Wet/Dry Stone Cutter
ESC-250	6"	10,000	220V	7/8" (22.23mm)	Wet/Dry Stone Cutter

ESC-150

MITER CUTTING KIT



SAVE TIME & INCREASE PRODUCTIVITY

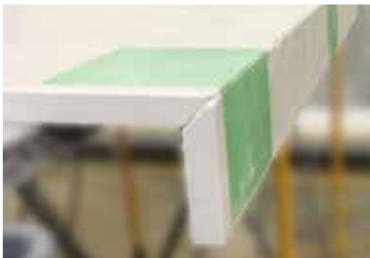

- Wet/Dry Electric Stone Cutters for Industrial Applications
- Powerful Motor For Use On Granite, Quartz Surfaces, Marble, Limestone, Concrete & Sintered/Porcelain Slabs
- One-Time setup on the Guide Rail allows for two different miter cut positions for lamination
- Precise Miter Cutting for Laminated Waterfall Edges and Book Matching
- Miter Cuts 1-1/4" (3cm) Materials with Ease

PART NO.	SIZE	TYPE	ARBOR(S)	DESCRIPTION
5480-5150	6"	110V	7/8" (22.23mm)	ESC-150 Miter Cutting Kit
5480-5152	6"	220V	7/8" (22.23mm)	ESC-250 Miter Cutting Kit

KIT INCLUDES: (2) ESC-150 Electric Wet/Dry Stone Cutters, (2) ASC-6CSM Guide Rail Carriage Assemblies, ASC Series Guide Rail Set (ASC-GR04, ASC-GR07, ASC-GR12), Surface Protection Tape (BAB0650)

ESC-150 COUNTERTOP TRIM KIT

COMPLETE TRIM KIT
FOR A CUSTOM-LOOK

6" COUNTERTOP TRIM KIT



Part number: 5480-4250

- Recommended for Hard Surfaces
- Eclipse II Blade has 8mm Tall Diamond Layer for a Long Life
- Perfect for your Stone and Tile Application
- High-End General Purpose Turbo Blade for Stone Fabricators
- Consistent Performance without Chipping
- One Year Tool Warranty (*See manual for details*)

Complete Trim Kit for a Custom Look

INCLUDES:

Wet/Dry Stone Cutter
ESC-150

6" Eclipse Blade
DEE006

6" Carriage Assembly
for Stone Cutter
ASC-6CSM

4' Guide Rail with Clamps
ASC-GR04

Surface Protection Tape
BAB0650



PART NO.	DESCRIPTION
5480-4250	Countertop Trim Kit (ESC-150)
5480-4252	Countertop Trim Kit (ESC-250)

STONE CUTTER

ECC-125

ECOCUTTER



- Virtually Dust-Free
- Portable Cutting System
- Accurate Cutting Performance
- Eliminates Downtime
- Built-in In-line circuit breaker
- Great for Grout Removal, Crack Chasing & Concrete Profiling
- One Year Warranty (*See manual for details*)

SPECIFICATION	DATA
Model	ECC-125
Rating	110 Volts
Amperage	11.2A
Power	1200W
No Load Speed (min-1)	12,000 RPM
Weight	9.5 lbs (4.3 kgs)
Arbor	7/8" (22.23mm)
Cutting Diameter	5" (125mm)
Maximum Cutting Depth	1-1/8" (29mm)

ITEM	QUANTITY
Dust Hose	1
Dust Gate	1
Side Handle	1
Hexagon Ring Spanner	1
Wrench	1
Dust Bag	1
TT Ruler	1
Hook & Loop Strap	2

PART NO.	SIZE	TYPE	ARBOR(S)	DESCRIPTION
ECC-125	5"	110V	7/8" (22.23mm)	Ecocutter
133544	17" x 13-1/2" x 12"			Dust Bag w/strap
ECO-CARS		Steel		Dust Bag Carriage (includes Dust Bag)

DUST BAG CARRIAGE



CUTTING KIT

ECC-KIT

DRY PORCELAIN PAVER TILE CUTTING SYSTEM

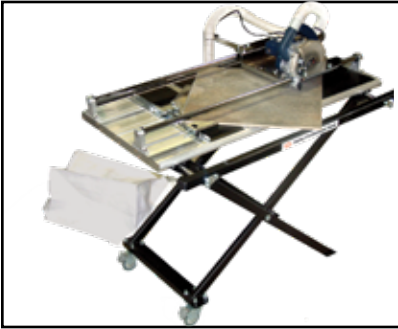

- Virtually Dust-Free
- Portable Cutting System
- Accurate Cutting Performance
- Eliminates Downtime and The Messy Cleanup
- Built-In Breaker Assembly
- Holds 3/4" Thick Porcelain Paver Tile
- One Year Tool Warranty (*See manual for details*)

SPECIFICATION	DATA
Model	ECC-KIT (ECC-125)
Rating	110 Volts
Amperage	11.2
Power	1200W
No Load Speed (min-1)	12,000 RPM
Weight	9.5 lbs (4.3 kgs)
Arbor	7/8" (22.23mm)
Cutting Diameter	5"(125mm)
Maximum Cutting Depth	1-1/8" (29mm) (without Ecocutter Table)

EQUIPMENT INCLUDED	QUANTITY
ECC-125	1
Dust Hose	1
Dust Gate	1
Side Handle	1
Hexagon Ring Spanner	1
Wrench	1
Dust Bag	1
TT Ruler Guide	1
Hook & Loop Strap	2
Ecocutter Table	1
Ecocutter Stand	1
Alpha® Ultracut GPM Blade 5"	1
Basic Instructional DVD	1

PART NO.	SIZE	TYPE	ARBOR(S)	DESCRIPTION
ECC-KIT	5"	110V	7/8" (22.23mm)	Dry Cutting System
ECC-125	5"	110V	7/8" (22.23mm)	Ecocutter
133544	17"x13-1/2 x 12"			Dust Bag w/strap
ECC-STAND				Dry Cutting System Stand
ECC-TABLE				Dry Cutting System Table
170005				Ecocutter DVD
PART NO.	SIZE	THICKNESS	MAX RPM	ARBOR(S)
GPM0578	5"	1.5mm	12,200	7/8"

AIR-680UW

HIGH-PERFORMANCE UNDERWATER PNEUMATIC POLISHER



- Central Water-Feed System Delivers Ample Water Regardless of Position for Plaster Polishing
- No-Load RPM- 4,000
- 15ft. All-Weather Air & Water Hoses with Flexibility Down To -40°F Or +140°F
- 30ft. All-Weather Air Hose with Flexibility Down To -40°F Or +140°F
- 27ft. Flexible Exhaust Hose included
- 7" Flexible Backer Pad included
- Lightweight and Ergonomically Designed for Better Maneuverability
- Side and C-Handle are Standard Accessories
- Enhanced Spindle Shaft for Easy Tool Removal (Wrench Included)
- One Year Warranty* (*See manual for details)

SPECIFICATION	DATA
Model	AIR-680UW
Air Pressure	85 PSI (6 Bar)
Air Consumption	15 CFM (425L/min)
Weight	2.64lbs (1.2 kgs)
No load Speed	4,000 RPM
Air Inlet	1/4" BSPP
Water Inlet	1/8" BSPP
Spindle	5/8"-11

ITEM	QUANTITY
Air Hose (15ft / 4.5m)	1
Water Hose (15ft / 4.5m)	1
Air Hose (30ft / 9.0m)	1
Side Handle (reversible)	1
C-Handle	1
Double End Wrench (19mm/22mm)	1
Screw (w/O-Ring Seal for Oil Port)	1
Phillips Screwdriver (P1)	1
Exhaust Hose with Clamp	1
Flexible Vacuum Hose (27ft / 8.1m)	1
Water Quick Coupler w/Shut Off Valve	1
Rust Inhibitor Oil (6.7oz / 200ml)	1
Rotary Backer Pad 7" (MP758HL)	1



Enhanced Spindle Shaft for Easy Tool Removal

(Wrench included)



PART NO.	MAXIMUM RPM	THREADS	RECOMMENDED FOR	DESCRIPTION
AIR-680UW	4,000	5/8"-11	Underwater Wet Polishing, Drilling & Profiling	Pneumatic Polisher

PLASTERING RESIN

POOL PLASTER POLISHING PADS

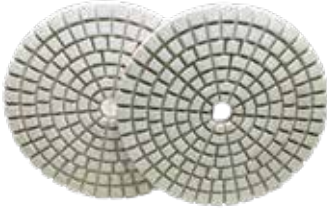

- Consistent performance through the life of disc
- 5mm thick diamond layer ensure a long life
- Plastering offers you the best cost/performance on the market
- Available in 7" and 9" diameter
- Grit #50 for aggressive grinding and Grit #100 for finishing
- Works with variety of tools that are used in the trade.



PART NO.	SIZE	THICKNESS	MAX RPM	GRIT	COLOR
PS070050	7"	5mm	5,500	50	Yellow
PS070100	7"	5mm	5,500	100	Red
PS090050	9"	5mm	5,500	50	Yellow
PS090100	9"	5mm	5,500	100	Red
MP758HL	7"	Rotary Backer Pad — 5/8"-11 Thread			

VDP-700

VARIABLE SPEED ROTARY POLISER



VDP-700

WET/DRY VARIABLE SPEED ROTARY POLISHER



*Backer and Pad Not Included

- Variable Speed 700-3500 RPM with Soft Start
- Designed For The Polishing Professional
- Heavy-Duty Precision Gear System
- Powerful 11.0 Amp (rated) Motor
- Built-in Speed Stabilizer for Constant Speed Output
- Configured with A Long-life Motor and Carbon Brushes
- 25ft. 14 AWG Electrical Power Cord
- Lightweight for Better Manueverability
- Industrial Quality Polisher
- C-Handle & Side Handle for User Convenience
- One Year Warranty (*See manual for details*)

SPECIFICATION	DATA
Model	VDP-700/VDP-714
Rating	120/230 Volts
Amperage	11.0A / 5.4A
Power	1250W (Rated), 1900W (Maximum)
No Load Speed (Variable)	700~3500 RPM w/Soft Start
Weight	6.4 lbs (2.9 kgs)
Spindle	5/8"-11 / M14-2
Power Supply	Single-phase AC, 50/60Hz
Plug Type	A (120V) / C(230V)
Cord	25ft (7.6m) / 16.8ft (5.1m) (14 AWG)
Backing Plate Size	7" (178mm) (Maximum)
Polishing Disc Size	9" (228mm) (Maximum)

ITEM	QUANTITY
Spanner Wrench	1
Hex Wrench	1
C-Handle w/Mounting Screws	1
Side Handle	1
Extra Carbon Brush Set	1



*Backer and Pad Not Included

PART NO.	SIZE	MAXIMUM RPM	TYPE	THREADS	DESCRIPTION
VDP-700	7"	700-3500	120V	5/8"-11	Variable Speed Rotary Polisher
VDP-714	7"	700-3500	230V	M14-2	Variable Speed Rotary Polisher

WET SANDING/ POLISHING KIT

KIT Part # WSPKIT



(optional)

WOOL PADS

REMOVES DEEP SCRATCHES WITH EASE



- Premium Performance and Heat-Resistant
- Smoother Handling and Reduced Vibration
- For Use on Rotary Polishers

PART NO.	SIZE	TYPE	RECOMMENDED FOR	MATERIAL	GRIT
WP003160	3"	Hook & Loop	Heavy Cutting	High-Nap Knitted Wool	T160
WP006160	6"	Hook & Loop	Heavy Cutting	High-Nap Knitted Wool	T160
WP007160	7"	Hook & Loop	Heavy Cutting	High-Nap Knitted Wool	T160

ROTARY BACKER PAD

FOR USE ON ROTARY POLISHERS



- Soft Molded Urethane With Flexible Edge
- Urethane Backing Makes for Greater Flexibility and Excellent Polishing
- Ideal for Contour Polishing
- For Use with Foam, Wool & Microfiber Pads
- Hook & Loop Allows for Fast Pad Changes
- Well Balanced for Smooth Polishing
- Absorbs Vibrations and Has Great Rebound Performance



Hook & Loop



Adhesive

PART NO.	SIZE	TYPE	RECOMMENDED FOR	THREADS
MP358HL	3"	Hook & Loop	Foam, Wool & Microfiber Pads	5/8"-11
MP558HL	5"	Hook & Loop	Foam, Wool & Microfiber Pads	5/8"-11
MP658HL	6"	Hook & Loop	Foam, Wool & Microfiber Pads	5/8"-11
MP758HL	7"	Hook & Loop	Foam, Wool & Microfiber Pads	5/8"-11
MP858HL	8"	Hook & Loop	Foam, Wool & Microfiber Pads	5/8"-11
MP858GL	8"	Adhesive	Foam, Wool & Microfiber Pads	5/8"-11

VSP-320

VARIABLE SPEED WET POLISHER



- Variable Speed 700-2500 RPM
- Heavy-Duty Gear System with Step-Down Transmission
- 15ft. Flexible All-Weather Water Hose
- 15ft. Electrical Power Cord Has An Inline GFCI
- EasyOn-EasyOff Sleeve Improves Maneuverability
- Adjustable Splash Guard
- Center Water-Feed System
- Ventilation Cap Diverts Water from Getting Into Motor Housing
- C-Handle & Side Handle for User Convenience
- One Year Warranty (See manual for details)

SPECIFICATION	DATA
Model	VSP-320
Rating	120 Volts
Amperage	7.0A
Power	800W
No Load Speed (Variable)	700~2500 RPM
Weight	7.3 lbs (3.3 kgs)
Spindle	5/8"-11
Power Supply	Single-phase AC, 50/60Hz
Plug Type	A (120V)
Cord	15ft (4.5m)
Polishing Disc Size	4" (100mm)

PART NO.	TYPE	DESCRIPTION
VSP-320	120V	Variable Speed Wet Polisher



ITEM	QUANTITY
Ground Fault Circuit Interrupter*	1
Flexible Hose w/ Garden Hose Adapter*	1
Wrench	1
C-Handle w/ Mounting Screws*	1
Side Handle (Reversible)	1
Extra Carbon Brush Set	1
Ventilation Cap w/ Rubber Band*	1
Splash Guard w/ Clamp	1
EasyOn-EasyOff Sleeve*	1

*Factory Attached



PAVER TILE BULLNOSE KIT

CREATES A FACTORY FINISH ON-SITE



- Designed To Create A Bullnose Edge On Tile or Stone and Polish It To A Factory Quality Finish
- Goof-Proof Hand-Held Application
- Quality Finish Without The Factory
- Save Time and Money
- Has Everything You Need
- Kit Contains: VSP-320 Polisher, Profiler V, 4" Ceramica EX Polishing Discs, 4" Flexible Backer Pad and Apron
- One Year Tool Warranty (See manual for details)



PROFILING



POLISHING



KIT INCLUDES:
 VSP-320, PFV201, GP45/8PD, EX40200R,
 EX40500R, EX41000R, EX42000R, EX43000R
 and APRON2000

PART NO.	DESCRIPTION
5480-1230	Paver Tile Bullnose Kit (VSP-320)

POOL COPING KIT

PROFILING

SANDING



KIT INCLUDES

VDP-700 VARIABLE SPEED ROTARY POLISHER

Professional Grade Industrial Polisher
Part #: **VDP-700**

WET SANDING/POLISHING KIT

Designed to convert a Variable Grinder, Sander or Polisher into a Wet Sanding/Polishing Tool
Part #: **WSPKIT**

PROFILER V

Creates A Perfect Bullnose/ Roundover Edge Treatment
Part #: **PFV501**

FLEXIBLE BACKER PAD 5"

High-Quality Backer Pad Is Extremely Flexible
Part #: **GP55/8PD**

SANDPAPER #80 GRIT

Multi-Purpose Sanding of Marble & Softer Types of Natural Stone
Part #: **MP50080**

MULTI-PURPOSE WATERPROOF APRON SLEEVELESS

Part #: **APRON2000**



KIT Part # 5480-6100

PART NO.	RECOMMENDED FOR	DESCRIPTION
5480-6100	Pool Coping	Pool Coping Kit

PLUS

ULTIMATE DRY BLADE FOR BLUE STONE



- Best Dry Cutting Turbo Blade on the Market
- Perfect for Blue Stone, Granite, and Other Hard to Cut Materials
- 8mm Tall Diamond Layer for a Long Life
- Recommended for Hard Concrete
- Chip-Free Cutting on Most Demanding Applications



PART NO.	SIZE	THICKNESS	MAXIMUM RPM	ARBOR(S)
DA0478	4"	2.1mm	14,500	7/8", 20mm, 5/8"
DA05A+	4-1/2"	2.1mm	13,200	7/8", 20mm
DA05S	5"	2.1mm	12,200	7/8"
DA06A+	6"	2.1mm	10,100	7/8", 5/8", ◀
DA07A+	7"	2.3mm	8,400	5/8", ◀
DA08A+	8"	2.3mm	7,400	5/8", ◀
DA09A+	9"	2.3mm	6,600	7/8", 5/8"
DA10A+	10"	2.5mm	5,900	1", 5/8"
DA11A+	10"	2.5mm	5,900	5/8"
DA12A+	12"	2.5mm	6,200	1", 20mm
DA13A+	12"	2.5mm	6,200	20mm

QUAD

ULTIMATE DRY FLUSH CUTTING BLADE



- Requires Quad Drive to fit High-Speed Angle Grinder
- Fits most popular High-speed Angle Grinders
- Specially Designed for Flush Cutting
- Best Dry Cutting Turbo Blade on the Market
- Chip-Free Cutting on Most Demanding Applications

PART NO.	SIZE	THICKNESS	MAXIMUM RPM	ARBOR(S)	THREADS
DA04AH	4"	2.1mm	14,500	20mm Quad Drive	
DA05SH	5"	2.1mm	12,200	20mm Quad Drive	
DA06AH	6"	2.1mm	10,100	20mm Quad Drive	
DA07AH	7"	2.3mm	8,400	20mm Quad Drive	
DA08AH	8"	2.3mm	7,400	20mm Flange with 8 holes	
DA09AH	9"	2.5mm	6,600	20mm Flange with 8 holes	
DA11AH	10"	2.5mm	5,900	20mm Flange with 8 holes	
AAH-20		Aluminum Adapter		20mm	5/8"-11
BAH-5/8		Brass Adapter		20mm	5/8"-11

ECLIPSE II

HIGH PERFORMANCE DRY BLADE



- High-End General Purpose Turbo Blade for Stone Fabricators
- 8mm tall Diamond Layer for a Long Life
- Perfect for your Stone Tile Application
- Consistent Performance without Chipping
- Recommended for Hard Concrete

PART NO.	SIZE	THICKNESS	MAXIMUM RPM	ARBOR(S)
DEE478	4"	2.1mm	14,500	7/8", 20mm, 5/8"
DEE045	4-1/2"	2.1mm	13,200	7/8", 20mm
DEE005	5"	2.1mm	12,200	7/8"
DEE006	6"	2.1mm	10,100	7/8", 5/8", ◀
DEE007	7"	2.3mm	8,400	5/8", ◀
DEE008	8"	2.3mm	7,400	5/8", ◀

ECLIPSE Q

HIGH PERFORMANCE DRY FLUSH CUTTING BLADE



- Requires Quad Drive or Flange Adapter to fit High-Speed Angle Grinder
- 8mm tall Diamond Layer for a Long Life
- Specially Designed for Flush Cutting
- High-End General Purpose Turbo Blade for Stone Fabricators
- Consistent Performance without Chipping



PART NO.	SIZE	THICKNESS	MAXIMUM RPM	ARBOR(S)	THREADS
DEQ004	4"	2.1mm	14,500	20mm Quad Drive	
DEQ005	5"	2.1mm	12,200	20mm Quad Drive	
DEQ578	5"	2.1mm	12,200	7/8" Quad Drive	
DEQ006	6"	2.1mm	10,100	20mm Quad Drive	
DEQ678	6"	2.1mm	10,100	7/8" Quad Drive	
DEQ007	7"	2.3mm	8,400	20mm Quad Drive	
DEQ008	8"	2.3mm	7,400	20mm Flange with 8 holes	
AAH-7/8		Aluminum Adapter		7/8"	5/8"-11
AAH-20		Aluminum Adapter		20mm	5/8"-11
BAH-5/8		Brass Adapter		20mm	5/8"-11

KATANA

ULTIMATE DRY BLADE FOR ALL TILES



- Tile Installer's Choice for Dry Cutting
- Specially Designed for 3/8" Hard Porcelain Tile
- Best Dry Cutting Tile Blade with Minimal Chipping
- Hybrid Dry Saw Blade for All Tiles
- Can Be used Wet or Dry

PART NO.	SIZE	THICKNESS	MAXIMUM RPM	ARBOR(S)
DPT478	4"	1.4mm	14,500	7/8", 20mm, 5/8"
DPT115	4-1/2"	1.4mm	13,200	7/8", 20mm
DPT125	5"	1.4mm	12,200	7/8"
DPT150	6"	1.4mm	10,100	7/8", 5/8", ◀

ULTRACUT GPM

**VACUUM-BRAZED
DIAMOND BLADE**



- Perfect for 2cm Porcelain Paver Tile
- Cuts most materials without chipping or cracking
- Maintains excellent cutting performance at the maximum cutting depth
- Great for building contractors and fabricators who work with metal and composite materials
- Fits on most popular hand-held electric power tools

PART NO.	SIZE	THICKNESS	MAXIMUM RPM	ARBOR(S)
GPM0420	4"	1.5mm	14,500	20mm, 5/8"
GPM4578	4-1/2"	1.5mm	13,200	7/8", 20mm
GPM0578	5"	1.5mm	12,200	7/8"
GPM06UN	6"	1.9mm	10,100	7/8", 5/8", ◀
GPM07UN	7"	1.9mm	8,400	7/8", 5/8", ◀
GPM08UN	8"	1.9mm	7,400	7/8", 5/8", ◀
GPM0978	9"	2.2mm	6,600	7/8", 5/8"

**Ultracut
GPM**



Q-CUT

THE ULTIMATE WET BLADE FOR PORCELAIN PAVER TILE



- Formulated To Cut Hard Tiles Such As Quartzite/ Granite
- Tile Installer's Choice for Stone Tile
- Designed for Fast, Precision Chip-Free Cutting
- Perfect for 2cm Porcelain Paver Tile
- Wet Use Only (*Except for 4-1/2" and 5" Blades Can Be Used Wet or Dry*)



**HARDSCAPE
CONTRACTOR'S
CHOICE FOR
PORCELAIN
PAVER TILE**



PART NO.	SIZE	THICKNESS	MAXIMUM RPM	ARBOR(S)
QZ4578	4-1/2"	1.6mm	13,200	7/8", 20mm
QZ0578	5"	1.6mm	12,200	7/8"
QZ0658	6"	1.4mm	10,100	7/8", 5/8", \diamond
QZ0758	7"	1.6mm	8,400	5/8"
QZ0858	8"	1.6mm	7,400	5/8"
QZ1058	10"	2.0mm	5,900	5/8"

PORCELLANA

ULTIMATE WET BLADE FOR PORCELAIN TILES



- 3/8" (10mm) Tall Diamond Layer for Long Life
- Tile Installer's Choice for Chip Free Wet Cutting
- Recommended for Granite, Marble, Porcelain, Engineered Stone, Travertine and Ceramic Tiles
- Best Wet Cutting Tile Blade on the Market
- Hybrid Wet Saw Blade for All Tiles
- Wet Use Only

PART NO.	SIZE	THICKNESS	MAXIMUM RPM	ARBOR(S)
PT04A+	4-3/8"	1.4mm	13,200	7/8", 20mm
PT05S	5"	1.4mm	12,200	7/8"
PT07A+	7"	1.6mm	8,400	5/8"
PT08A+	8"	1.6mm	7,400	5/8"
PT10A+	10"	1.6mm	5,900	5/8"

PORCELLANA for PRS

ULTIMATE WET BLADE FOR PORTABLE RAIL SAWS



- 3/8" (10mm) Tall Diamond Layer for Long Life
- Tile Installer's Choice for Chip-Free Wet Cutting
- Recommended for Granite, Marble, Porcelain, Engineered Stone, Travertine and Ceramic Tiles
- Best Wet Cutting Tile Blade for Rail Saw on the Market
- Hybrid Wet Saw Blade for All Tiles
- Wet Use Only



PART NO.	SIZE	THICKNESS	MAXIMUM RPM	ARBOR(S)
PT0801	8"	1.6mm	7,400	1", 7/8", 5/8"
PT1001	10"	1.6mm	5,900	1", 5/8"

VETRO

ULTIMATE WET BLADE FOR GLASS TILES



- Best Wet Cutting Glass Blade on the Market
- Designed for Chip-Free Cutting
- Tile Installer's Choice for Glass Tile
- Chip-Free Cutting on Most Demanding Applications
- Wet Use Only

PART NO.	SIZE	THICKNESS	MAXIMUM RPM	ARBOR(S)
WG0438	4-3/8"	1.0mm	13,200	7/8", 20mm
WG0700	7"	1.6mm	8,400	5/8"
WG0800	8"	1.6mm	7,400	5/8"
WG1000	10"	1.6mm	5,900	5/8"

VETRO for PRS

VETRO FOR PORTABLE RAIL SAW



- Wet Use Only
- Designed for Chip-Free Cutting
- Tile Installer's Choice for Glass Tile
- Best Wet Cutting Glass Blade for Rail Saw on the Market
- Chip-Free Cutting on Most Demanding Applications

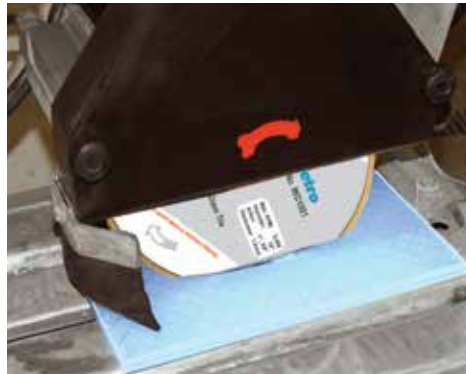

PART NO.	SIZE	THICKNESS	MAXIMUM RPM	ARBOR(S)
WG1001	10"	1.6mm	5,900	1", 5/8"

FLUSH CUTTING BLADE

VORTEX

INTRICATE & FLUSH CUTTING BLADE FOR GRANITE



- Requires Quad Drive to fit High-Speed Angle Grinder
- Perfect for Granite and Engineered Stone
- Specially Designed for Flush Cutting
- Stone Fabricator's Choice
- Chip-Free Cutting on Most Demanding Applications
- Side Protection Segments Help Cutting Straight



PART NO.	SIZE	THICKNESS	MAXIMUM RPM	ARBOR(S)	THREADS
FCD40AH	4"	2.5mm	14,500	20mm Quad Drive	
FCD50AH	5"	2.5mm	12,200	20mm Quad Drive	
AAH-20		Aluminum Adapter		20mm	5/8"-11
BAH-5/8		Brass Adapter		20mm	5/8"-11

VORTEX

INTRICATE & FLUSH CUTTING BLADE FOR MARBLE



- Requires Quad Drive to fit High-Speed Angle Grinder
- Specially Designed for Marble and Lime Stone
- Specially Designed for Flush Cutting
- Stone Fabricator's Choice
- Chip-Free Cutting on Most Demanding Application



PART NO.	SIZE	THICKNESS	MAXIMUM RPM	ARBOR(S)	THREADS
FCM50AH	5"	1.6mm	12,200	20mm Quad Drive	
AAH-20		Aluminum Adapter		20mm	5/8"-11
BAH-5/8		Brass Adapter		20mm	5/8"-11

ULTRACUT APR SERIES

HYBRID BLADE FOR INTRICATE & FLUSH CUTTING



- Unique Design for Flush Cutting Applications
- Removes Anchor Bolts, Concrete Re-Bar and Pipe From Floors and Walls
- Great for Building Contractors and Fabricators Who Work with Metal and Composite Materials
- Accepts Alpha® Exclusive Quad Drive Adapter for Mounting On Angle Grinders for “Flush Cutting”
- Available in 4-1/2”, 5” and 7”



PART NO.	SIZE	THICKNESS	MAXIMUM RPM	ARBOR(S)	THREADS
APR45QA	4-1/2"	1.7mm	13,200	20mm, Quad Drive	
APR05QA	5"	1.7mm	12,200	20mm, Quad Drive	
APR07QA	7"	1.9mm	8,400	20mm, Quad Drive	
BAH-5/8			Brass Adapter	20mm	5/8"-11
AAH-20			Aluminum Adapter	20mm	5/8"-11



CONTOUR

CURVE CUTTING BLADE FOR PORCELAIN/CRYST. GLASS

CONTOUR FOR PORCELAIN

Curve Cutting on Porcelain, Crystallized Glass and Sintered Slabs



- Perfect for 2cm Porcelain Paver Tile
- Designed Specifically for Cutting Porcelain and Sintered Slabs
- Fits On Wet/Dry Stone Cutters
- Cuts Curved Areas Cleanly, Accurately and Safely While Allowing A Wider Kerf
- Direct Sintered Diamond Segments On Steel Core Prevents Undercutting
- Perfect to Cut Pool Skimmer Hole
- Can Be Used Either Wet or Dry

PART NO.	SIZE	THICKNESS	MAXIMUM RPM	ARBOR(S)	DEPTH OF CUT
CCP004	4"	4.0mm	14,500	7/8"	3/4"
CCP045	4-1/2"	4.0mm	13,200	7/8"	3/4"
CCP005	5"	4.0mm	12,200	7/8"	1-1/4"

CONTOUR

CURVE CUTTING BLADE FOR GRANITE AND ENG. STONE



- Specifically Developed for Cutting Granite Sinkholes
- Best Seller for Sinkhole Application
- Works Very Well On Engineered Stone, Quartzite and Harder Types of Natural Stone
- Cuts Curved Areas Cleanly, Accurately and Safely While Allowing A Wider Kerf
- Fits on Wet/Dry Stone Cutters
- Direct Sintered Diamond Segments On Steel Core Prevents Undercutting
- Fits On CNC Router with Cutting Head
- Can Be Used Either Wet or Dry



PART NO.	SIZE	THICKNESS	MAXIMUM RPM	ARBOR(S)	DEPTH OF CUT
CCB004	4"	4.0mm	14,500	7/8"	3/4"
CCB045	4-1/2"	4.0mm	13,200	7/8"	3/4"
CCB005	5"	4.0mm	12,200	7/8"	1-1/4"
CCB006	6"	4.0mm	10,100	7/8"	1-5/8"

HOT-ROD

CHANNEL CUTTING BLADE FOR STAIR TREADS



- Perfect for Channel Cutting with Wet/Dry Stone Cutters
- Great for Grout Removal with Ecocutter
- Perfect to Cut Anti-Slip Grooves and Water Drip
- Reliable Proven Performer
- Can Be Used Wet or Dry

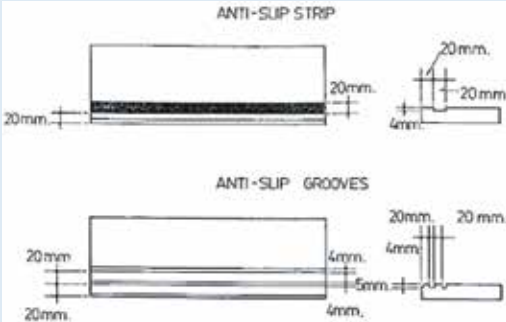

ROD SIZE



GROUT WIDTH

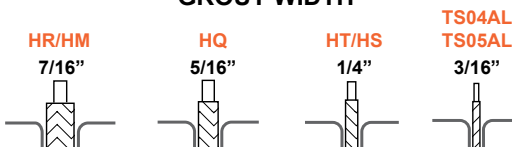

PART NO.	SIZE	THICKNESS	MAXIMUM RPM	ARBOR(S)	RECOMENDED FOR
HP03A+	3"	6.0mm	14,500	7/8", 20mm	Porcelain
HA03A+	3"	7.0mm	14,500	7/8", 20mm	Porcelain
HT03A+	3"	4.2mm	14,500	7/8", 20mm	Granite/Quartz Surfaces
HQ03A+	3"	5.5mm	14,500	7/8", 20mm	Granite/Quartz Surfaces
HR03A+	3"	7.0mm	14,500	7/8", 20mm	Granite/Quartz Surfaces
HW03A+	3"	11.5mm	14,500	7/8"	Granite/Quartz Surfaces
HS03A+	3"	4.75mm	14,500	7/8", 20mm	Marble
HM03A+	3"	6.5mm	14,500	7/8", 20mm	Marble
HT04A+	4"	4.2mm	14,500	7/8", 20mm	Granite/Quartz Surfaces
HR04A+	4"	7.0mm	14,500	7/8", 20mm	Granite/Quartz Surfaces

PT CUTTER

ULTIMATE DRY BLADE FOR PORCELAIN PAVER TILE



- Best Dry Cutting Turbo Blade on the Market
- Perfect for Porcelain Paver Tile
- 6mm Tall Diamond Layer for a Long Life
- Recommended for Landscaping Tiles
- Fits Most Gas-Powered Demolition Saws
- Can Be Used Wet or Dry
- Special Turbo Rim Diamond Layer Sintered Directly to the Steel Core
- Can Be Used On Portable Rail Saws



PART NO.	SIZE	THICKNESS	MAXIMUM RPM	ARBOR(S)
LT09A+	9"	2.5mm	6,600	7/8", 5/8"
LT12A+	12"	2.6mm	6,200	1", 7/8", 20mm
LT14A+	14"	2.8mm	5,360	1", 7/8", 20mm

BLADES FOR ENGINE CUTTER

BLADEMASTER

HIGH-SPEED DIAMOND BLADE FOR PORCELAIN PAVER TILE



- High-Quality Laser-Welded Segmented Blades for High-Speed Demolition Saws
- Slices Through Materials with Ease
- Segment Height at 1/2" Ensure a Long Life
- Fits Masonry Saws & Road Cutters
- Can Be Used Wet or Dry
- Available in 12", 14" and 16" Diameters with Pin Hole

PART NO.	SIZE	THICKNESS	MAXIMUM RPM	ARBOR(S)
BML1214	12"	2.9mm	6,200	1" w/pin hole
BML1414	14"	3.0mm	5,360	1" w/pin hole
BML1614	16"	3.1mm	4,700	1" w/pin hole

RESCUE

DEMOLITION BLADE CUTS IT ALL



- Slices Through Most Materials with Ease
- Works on Concrete, Paver, Stone, PVC Pipe, Ductile Iron, Granite, Tavertine, Blue Stone, Brick Block, Wood, Glass and Rubberized Materials
- Proven Winner for Firefighters, Police Officers and Construction Professionals
- Use on Gas-Powered Cut-Off Saw
- Available in 9", 12" and 14" Diameters

PART NO.	SIZE	THICKNESS	MAXIMUM RPM	ARBOR(S)
RB09A+	9"	2.8mm	8,300	7/8"
RB12A+	12"	3.0mm	6,200	1", 7/8", 20mm w/Pin Hole
RB14A+	14"	3.2mm	5,360	1", 7/8", 20mm w/Pin Hole
DR14A+	14"	3.4mm	5,360	1", 7/8", 20mm



QUAD ADAPTERS



- Designed for Flush Cutting Blades with Four Mounting Holes
- Made Of Durable High-Quality Brass or Aluminum
- Easily Mounted To Any Quad Drive Blade
- Available in Various Thread Sizes

PART NO.	TYPE	ARBOR(S)	THREADS
AAH-7/8	Aluminum	7/8"	5/8"-11
AAH-20	Aluminum	20mm	5/8"-11
BAH-5/8	Brass	20mm	5/8"-11
BAH-M10Q	Brass	20mm	M10 - 1.25
BAH-M14	Brass	20mm	M14-2

FLANGE ADAPTERS



- Designed for Blades That Are Eight Inches or Larger with Eight Mounting Holes
- Made Of Durable High-Quality Steel
- Easily Mounted To Any Large Flush Cutting Blade
- Available in 5/8"-11 and M14-2 Thread Sizes

PART NO.	TYPE	THREADS
FAH-5/8	Adapter	5/8"-11
FAH-M14	Adapter	M14-2

SPIKE RULER



- Designed As A Precision Ruler That Will Not Move On Thin Porcelain Tiles or Panels with Texturized Surfaces
- Secures Ruler To The Material
- Convenient and Easy To Use
- Made Of Aluminum with A Wood Base

PART NO.	SIZE
SPR100	3'4" (1m)

DRESSING STICK



- Designed To Expose New Cutting Surfaces or Re-Open Glazed Diamond Blades and Grinding Wheels
- Removes Sinter Bond From Cutting Edge
- Can Be Used To Ease Sharp Corners
- Bond Type: Silicon Carbide

PART NO.	SIZE	GRIT
290006	8" x 1.5" x 1.5"	60

PROFILER B-SERIES

**CREATES PERFECT
DEMI-BULLNOSE EDGE**

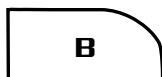

Demi-Bullnose

- Perfect for 2cm Porcelain Paver Tile
- Use On Travertine, Granite, Engineered Stone, Marble, Concrete, Crystallized Glass and Porcelain Slabs
- Create A Perfect Demi-Bullnose/Roundover Edge Treatment
- Nylon Guide and Rotary Touchier Assures The Proper Depth Of Cut Is Achieved
- Equipped with A 5/8"-11 Female Thread and Internal Water Passage Holes
- Fits On All Popular Water-Fed Polishers

PART NO.	SIZE	MAXIMUM RPM	THREADS	SHAPE
PFB051	3/16" (0.5cm)	3,500	5/8"-11	Demi-Bullnose
PFB101	3/8" (1.0cm)	3,500	5/8"-11	Demi-Bullnose
PFB131	1/2" (1.3cm)	3,500	5/8"-11	Demi-Bullnose
PFB201	3/4" (2.0cm)	3,500	5/8"-11	Demi-Bullnose
PFBNG01	Fits up to 4cm Profilers	3,500	Nylon Guide	
PFBNG02	Fits All Sizes of Profilers	6,000	Nylon Guide	

PROFILER Z-SERIES

**PERFECT 90-DEGREE
EDGE GRINDING**

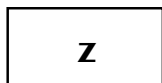

Straight Edge

- Perfect for 2cm Porcelain Paver Tile
- Vertical Grinding On All Types Of Materials
- Never Loses Shape for True Zero Tolerance
- Nylon Guide and Rotary Touchier Assures Uniformity
- Equipped with A 5/8"-11 Female Thread and Internal Water Passage Holes
- Fits On All Popular Water-Fed Polishers

PART NO.	SIZE	MAXIMUM RPM	THREADS	SHAPE
PFZ301	1-1/4" (3cm)	3,500	5/8"-11	Straight
PFZ401	1-1/2" (4cm)	3,500	5/8"-11	Straight
PFZ501	2" (5cm)	6,000	5/8"-11	Straight
PFBNG01	Fits up to 4cm Profilers	3,500	Nylon Guide	
PFBNG02	Fits All Sizes of Profilers	6,000	Nylon Guide	

PROFILER V-SERIES

CREATES PERFECT BULLNOSE EDGE

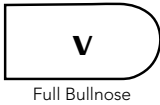

- Perfect for 2cm Porcelain Paver Tile, Pool Coping, Steps and Caps
- Create A Perfect Bullnose/Roundover Edge Treatment
- Use On Travertine, Granite, Engineered Stone, Marble, Limestone, Concrete, Crystallized Glass and Porcelain Slabs
- Eliminate The Time-Consuming Calibration Process for Seamed Pieces
- Nylon Guide and Rotary Touchier Assures The Edges Are Uniform
- Equipped with A 5/8"-11 Female Thread and Internal Water Passage Holes
- Fits On All Popular Water-Fed Polishers

PART NO.	SIZE	MAXIMUM RPM	THREADS	SHAPE
PFV201	3/4" (2cm)	3,500	5/8"-11	Full Bullnose
PFV301	1-1/4" (3cm)	3,500	5/8"-11	Full Bullnose
PFV401	1-1/2" (4cm)	3,500	5/8"-11	Full Bullnose
PFV501	2" (5cm)	6,000	5/8"-11	Full Bullnose
PFV601	2-3/8" (6cm)	6,000	5/8"-11	Full Bullnose
PFBNG01	Fits up to 4cm Profilers	3,500	Nylon Guide	
PFBNG02	Fits All Sizes of Profilers	6,000	Nylon Guide	



PROFILER B



PROFILER V



PROFILER Z

SPIKE DISC

COATING REMOVAL MADE EASY



- Designed for Thick Coating Removal of Epoxy, Urethane, Glue and Adhesives
- Unique Open-Mesh Layout Reduces Clogging and Heat Build-Up
- Optimized Diamond Grits Provide A Consistent Performance
- Sandwiched-Rubber Cushioned Light-Weight Body Reduces Noise and Vibration
- Each Diamond Bead Has Multiple Diamond Grits To Maintain A Sharp Cutting Capability for A Long Time
- Can Be Used On Wood, Glass Fiber Reinforced Polymer and Carbon Fiber Reinforced Polymer.
- Available in 4-1/2", 5" and 7" with 7/8" Arbor or with 5/8"-11 Zinc Hub and A Square Arbor for Spring Load Systems
- Combine with The Ecoguard G for A Virtually Dust-Free Solution

PART NO.	SIZE	MAXIMUM RPM	ARBOR(S)	GRIT
VCS4535	4-1/2"	13,200	7/8"	35
VCS453H	4-1/2"	13,200	5/8"-11	35
VCS4550	4-1/2"	13,200	7/8"	50
VCS455H	4-1/2"	13,200	5/8"-11	50
VCS5035	5"	13,200	7/8"	35
VCS503H	5"	12,200	5/8"-11	35
VCS503Q	5"	12,200	Sq Arbor	35
VCS5050	5"	12,200	7/8"	50
VCS505H	5"	12,200	5/8"-11	50
VCS7035	7"	8,400	7/8"	35
VCS703H	7"	8,400	5/8"-11	35
VCS7050	7"	8,400	7/8"	50
VCS705H	7"	8,400	5/8"-11	50



close-up of diamonds

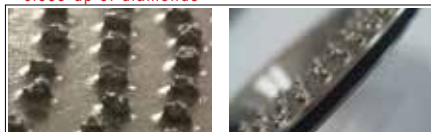

sandwich construction

WET CORE BITS

ULTIMATE WET CORE DRILLING BIT



- Perfect for Porcelain Paver Tile
- Designed for Drilling The Faucet-Mounting Holes in Countertops and Vanities
- Very Fast Cutting On Granite and Engineered Stone
- Make Clean Rounded Corners for Square or Rectangular Sinkholes
- Versatile and Adaptable in Many Industries for Water, Gas and Electrical Piping
- Fits On Most Popular Water-Fed Polishers

PART NO.	DIAMETER	MAXIMUM RPM	THREADS
DCB00380	3/8"	3,500	5/8"-11
DCB00500	1/2"	3,500	5/8"-11
DCB00750	3/4"	3,500	5/8"-11
DCB01000	1"	3,500	5/8"-11
DCB01250	1-1/4"	3,500	5/8"-11
DCB01375	1-3/8"	3,500	5/8"-11
DCB01500	1-1/2"	3,500	5/8"-11
DCB02000	2"	3,500	5/8"-11
DCB02500	2-1/2"	3,500	5/8"-11

DRY CORE BITS

HIGH-SPEED DRY CORE BIT FOR GRANITE/ENG. STONE



- Perfect for Porcelain Paver Tile
- Designed for Jobsite Drilling Of Faucet-Mounting Holes in Countertops and Vanities
- Very Fast Cutting On Granite and Engineered Stone
- Convenient Dry Application
- Make Clean Rounded Corners for Square or Rectangular Sinkholes
- Versatile and Adaptable in Many Industries for Water, Gas and Electrical Piping
- Fits On Most Popular High-Speed Grinders

PART NO.	DIAMETER	MAXIMUM RPM	THREADS
DRB00500	1/2"	12,000	5/8"-11
DRB00750	3/4"	12,000	5/8"-11
DRB01000	1"	12,000	5/8"-11
DRB01250	1-1/4"	12,000	5/8"-11
DRB01375	1-3/8"	12,000	5/8"-11
DRB01500	1-1/2"	12,000	5/8"-11
DRB02000	2"	12,000	5/8"-11

VACUUM BRAZED TRIMMER BIT

DRY CUTTING OF LARGE HOLES OR CURVED LINES



- Great For Use In Construction Trades Wherever Non-Standard Shaped Cutouts As Needed
- Perfect For Electrical Receptacles, Water-Valve Holes, Drains, Shower Knobs, Etc.
- Vacuum Brazed Technology Provides Extended Life
- Use On Granites, Engineered And Natural Stones, Porcelain And Ceramic Tiles
- Can Be Used Wet Or Dry
- Fits On A High-Speed Trimmer Tools

PART NO.	DIAMETER	MAXIMUM RPM
DTB00250	1/4"	33,000

ELECTROPLATED DRILL BITS

PREMIUM DRILL BITS FOR ANCHOR/PIPE HOLES



- Designed for Drilling Holes in Tile and Stone for Pre-Installation or Post-Installation Placement
- Works Great On Marble, Granite, Engineered Stone, Ceramic, Porcelain and Glass Tile and Panels
- Can Be Used On A Standard 3/8" or Larger Drill
- Can Fit On Water-Fed Polishers with 5/8"-11 Spindles Using The Drill Bit Adapter
- Ideal for Drilling Holes for Anchors for Bathroom Fixtures, Faucet and Plumbing Pipes
- Available in 3/16", 1/4", 5/16", 3/8", 1/2", 1-3/8" and 1-1/2" Sizes
- Wet Use Only

PART NO.	DIAMETER	MAXIMUM RPM	TYPE
CH7205	3/16"	3,500	3/8" Shank
CH7206	1/4"	3,500	3/8" Shank
CH7208	5/16"	3,500	3/8" Shank
CH7210	3/8"	3,500	3/8" Shank
CH7212	1/2"	3,500	3/8" Shank
CH7235	1-3/8"	3,500	3/8" Shank
CH7240	1-1/2"	3,500	3/8" Shank
CH1058			Adapter 10mm to 5/8**

*(for all polishers)

DRILL BIT GUIDE

WATER DELIVERY SYSTEM



- Prevents Wandering Drill Bits
- Delivers Sufficient Water While Providing A Secure Drilling Position
- Fits Up To 1-3/8" Diameter
- Use It with Electroplated Drill Bits
- Ideal When Drilling 1/4" Anchor Holes When Installing Towel Bars, Soap Dishes, Shelves, Cabinets and Shower Door Frames
- Suction Cup Creates A Vacuum That Secures The Guide During Application

HOW TO USE:



Soak the foam rubber on the back side with water.



Press the body to the tile and make sure it adheres properly.



Pour water up to the mark On the tank.



Slide the switch to the open position. Make sure the water drips.



Place tip of drill bit into the guide Position. Then start drilling.



Slide switch to the closed position. Pull the rubber to remove the water-feed system.



NOTE: working with mosaic tile or near grout lines use tape to secure.*

PART NO.	DESCRIPTION
WDS138	Drill Bit Guide/Water Delivery System

HAND PADS

HAND POLISHING PADS

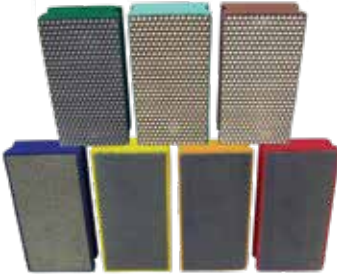

- Convenient, On-Site Polishing
- Use On Travertine, Porcelain Paver Tile, Glass, Ceramics, Marble, Granite, Concrete, Terrazzo and Quartz Surfaces
- Two Bond Types To Provide The Best Possible Finish
- Available in Electroplated and Resin Grits



ELECTROPLATED GRITS:

This type of pad uses nickel plating technology to hold each individual diamond in place and is available in 60, 150, 300 and 500 grits.

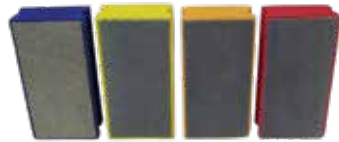

RESIN GRITS:

This type has a finer diamond grit than electroplated pads. The resin bond is coated on a special backing material and is available in 1000, 2000 and 3000 grits best suited for honing to polishing.

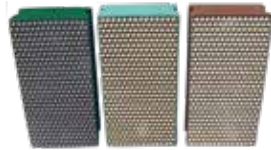

PART NO.	GRIT	COLOR	BOND TYPE
DHP0060	60	Blue	Electroplated
DHP0150	150	Yellow	Electroplated
DHP0300	300	Orange	Electroplated
DHP0500	500	Red	Electroplated
DHP1000	1000	Dark Green	Resin
DHP2000	2000	Light Green	Resin
DHP3000	3000	Brown	Resin
DHPKIT			Set of 7

CERAMICA EX

WET POLISHING FOR ALL STONES



- Produces A High-Quality Shine
- Polishes On Porcelain, Granite, Travertine, Limestone, Concrete, etc.
- Ideal for Polishing Inside Corners and A Tight Radius
- Works Very Well On Tough Materials Including Tough To Polish Black and Green Marbles
- Extremely Flexible

HOOK AND LOOP		3"	4"	5"
GRIT	COLOR	PART NO.	PART NO	PART NO.
200	Yellow	EX30200R	EX40200R	EX50200R
500	Red	EX30500R	EX40500R	EX50500R
1000	Dark Green	EX31000R	EX41000R	EX51000R
2000	Light Green	EX32000R	EX42000R	EX52000R
3000	Brown	EX33000R	EX43000R	EX53000R
ALL	Assortment (1 each)		EX40KIT	

SANDPAPER

CONCRETE AND MARBLE POLISHING



- Waterproof Hook and Loop Backed Silicon Carbide Abrasive
- Use On Marbles and Softer Types of Natural Stone
- Can Also Be Used To Polish Glass, Metal and Wood
- Very Adaptable To Onsite Work and Easy To Use
- Resists Clogging When Used Wet
- Can Be Used Wet or Dry

HOOK AND LOOP		4"	5"
GRIT	QUANTITY	PART NO.	PART NO.
80	50	MP40080	MP50080
120	50	MP40120	MP50120
240	50	MP40240	MP50240
320	50	MP40320	MP50320
400	50	MP40400	MP50400
500	50	MP40500	MP50500
600	50	MP40600	MP50600
Assortment	50	MP40KIT	MP50KIT

ANTIQUE BRUSH WHEELS

BRUSH WHEELS FOR TEXTURED FINISHES



- Create A Textured Finish On The Edge and Surface Of Engineered Stone/Quartz Surfaces
- Developed with TYNEX®, A Filament From Dupont, To Ensure Safety and Exceptional Performance
- Utilizes A Snail Lock Adapter (SFAT)
- Fits Most Popular Edge Polishing Machines, Hand-Held Sanders and Polishers
- Grits Sequence of #24, #36, #60, #120, #240 and #320
- Can Be Used On Other Stone Such As Granite



SNAIL LOCK			4"	5"
GRIT	BOND TYPE	MAXIMUM RPM	PART NO.	PART NO.
24	Resin	4,000	AB4024	AB5024
36	Resin	4,000	AB4036	AB5036
60	Resin	4,000	AB4060	AB5060
120	Resin	4,000	AB4120	AB5120
240	Resin	4,000	AB4240	AB5240
320	Resin	4,000	AB4320	AB5320
Snail Lock Adapter		4,000	PVA-5/8	
Snail Lock Adapter		2,000		SFAT-5/8

ECOGUARD C

HYBRID DUST COLLECTION COVER FOR CUTTING



- Designed for Collecting Dust When Using A High-Speed Angle Grinder
- Accepts Up To 5" Diameter Blades
- Can Be Used with or Without A Vacuum
- Rugged Construction for Heavy-Duty Applications
- Removes More Than 90% Of Dust
- Fits On Selected 4-1/2" - 5" High-Speed Angle Grinders
- Straight Precise Cuts Using Foot Plate
- Adjustable Cutting Depth

PART NO.	SIZE	DESCRIPTION
ECOGRDCT	5"	Dust Collection Cover C
201549		Dust Bag
500026	18"	Flexible Connector Hose (1-1/2" Tapered-2-1/4")
500073	54"	Flexible Connector Hose (1-1/2" Tapered-2-1/4")

ECOGUARD D

DUST AND DEBRIS GUARDS FOR DRILLS / HAMMER DRILLS



- Collects Dust & Debris with Ease While Using Drills/ Hammer Drills
- Convenient and Easy to Use
- Eliminates Clean-Up and Downtime on the Jobsite
- Fits Most Popular Drills and Hammer Drills
- Made for: Makita® BHR202Z, Bosch RHH180, DeWalt DCH253, Milwaukee 2605-20, Hilti TE4-A18



Optional Universal Handle



Optional Vacuum Adapter Kit



Optional Exhaust Hose

PART NO.	SIZE	RECOMMENDED FOR	DESCRIPTION
ECOGRDDL	≥ 6"	Long Drill Bits	Dust Collection Cover DL
ECOGRDDS	≤ 6"	Short Drill Bits	Dust Collection Cover DS
803172		Ecoguard D	Universal Handle for Hammer Drills
ECOVAKIT		Use With Ecoguard D	Vacuum Adapter Kit
VH91100	12ft /3.6m	3/4" Hose Diameter	Exhaust Hose 1-1/4" O.D. threaded x 2-1/4" standard

ECOGUARD CD

DUST AND WATER GUARD FOR CORE DRILLING



- Wet/Dry Cover for Drilling and Core Drilling Applications
- Fits Most Vacuum Dust Hoses
- Accepts up to 2-1/2" Core Bit
- Can Be Secured On Horizontal and Vertical Surfaces with Vacuum During Application
- Prevents Splashing When Used with Water

PART NO.	RECOMMENDED FOR	DESCRIPTION
ECOGRDCD	Core Drilling	Dust Collection Cover CD

ECOGUARD G5 / G7

DUST COLLECTION COVER FOR GRINDING



- Designed for Collecting Dust When Using A High-Speed Angle Grinder
- Accepts Grinding Wheels Up To: 5" (G5), 7" (G7)
- Rugged Construction for Heavy-Duty Applications
- Perfect for Grinding and Sanding or Surface Preparation Work
- Can Grind Tight Against The Wall
- Clear Cover for Better Visibility
- Fits On Most High-Speed Angle Grinders: 4-1/2"- 5" (G5), 7" & 9" (G7)
- Easy Installation and Wheel Changes
- The G7 Has A Flexible Head Allowing for A Natural Grinding Motion
- Removes More Than 90% of the Dust
- Must Be Used with A Vacuum

PART NO.	SIZE	DESCRIPTION
ECOGRDGR	5"	Dust Collection Cover G5
ECOGRDG7	7"	Dust Collection Cover G7
500026	18"	Flexible Connector Hose (1-1/2" Tapered-2-1/4")
500073	54"	Flexible Connector Hose (1-1/2" Tapered-2-1/4")
ECOG5KIT	5"	Ecoguard G5 & 18" Connector Hose Kit
ECOG7KIT	7"	Ecoguard G7 & 54" Connector Hose Kit

ECOGUARD G7



PART#: ECOGRDG7

ECOGUARD W5 / W6 / W9

DUST COLLECTION COVER FOR WIDER KERF CUTTING



PART#: **ECOGRDW6**



PART#: **ECOGRDW5**

- Designed for Collecting Dust and Debris When Using A High-Speed Angle Grinder
- Perfect for Tuckpointing and Crack Chasing
- Accepts 5" Diameter Blades (W5), 6" Diameter Blades (W6), 7" and 9" Diameter Blades (W9)
- Removes More Than 90% Of Dust
- Rugged Construction for Heavy-Duty Applications
- Straight Precise Cuts Using Support Base
- Easy Installation and Blade Changes
- Fits On Selected 4-1/2", 5", 6", 7" and 9" High-Speed Angle Grinders
- Adjustable Cutting Depth - Maximum 1-1/2" (W5), 1-3/4" (W6) and 2-3/8" (W9)
- Must Be Used with A Vacuum

**Industrial
Dust
Collection
Cover**



PART#: **ECOGRDW9**



**Includes
extendable
handle
bracket**

PART#: **ECOW9KIT**

PART NO.	SIZE	DESCRIPTION
ECOGRDW5	5"	Dust Collection Cover W5
ECOGRDW6	6"	Dust Collection Cover W6
ECOGRDW9	9"	Dust Collection Cover W9
500026	18"	Flexible Connector Hose (1-1/2" Tapered-2-1/4")
500073	54"	Flexible Connector Hose (1-1/2" Tapered-2-1/4")
ECOW5KIT	5"	Ecoguard W5 & 18" Connector Hose Kit
ECOW6KIT	6"	Ecoguard W6 & 18" Connector Hose Kit
ECOW9KIT	9"	Ecoguard W9 & 54" Connector Hose Kit includes Extendable Handle Bracket (Part# 510000)

BACKER PADS

RIGID BACKER PADS



- High-Quality Backer Pad Is Super Rigid and Flat
- Eliminates The Wavy Finish When Polishing
- Hook and Loop Backed
- The Rigidity Of The Pad Enables Work in Small Areas Such As Corners or Staircases
- Accepts Polishing Pads, Sandpaper and Felt Wheels

PART NO.	SIZE	MAX RPM	THREADS
GP35/8RG	3"	6,000	5/8"-11
GP45/8RG	4"	6,000	5/8"-11
GP55/8RG	5"	6,000	5/8"-11
RGSPACER			Spacer

FLEXIBLE BACKER PADS



- High-Quality Backer Pad Is Extremely Flexible
- Ideal for Tough Contours and Inside Curves
- Hook and Loop Backed
- Highly Resistant To The Rigors Of Daily Use Provides A Long Life
- Accepts Polishing Pads, Sandpaper and Felt Wheels

PART NO.	SIZE	MAX RPM	THREADS
GP25/8PD	2"	6,000	5/8"-11
GP35/8PD	3"	6,000	5/8"-11
GP45/8PD	4"	6,000	5/8"-11
GP55/8PD	5"	6,000	5/8"-11

GV BACKER PADS



- High-Quality Backer Pad Is Rigid and Flat, But Provides Just The Right Amount Of Flexibility
- Ideal for Bullnosed Edges and Flat Surfaces.
- Hook and Loop Backed
- Accepts Polishing Pads, Sandpaper and Felt Wheels
- Fits On Makita® GV5000 & GV5010 Sanders

PART NO.	SIZE	MAXIMUM RPM	DESCRIPTION
GV4MPPD	4"	4,500	M8-1.25 Male
GV5MPPD	5"	4,500	M8-1.25 Male

WET BLADE CUTTING KIT

CONVERT A HIGH-SPEED ANGLE GRINDER INTO A WET TOOL



WBC9KIT



- Can Be Used On Most Grinders With Minimal Alterations
- Fits Most 7" and 9" Angle Grinders
- Includes Kink-Free, Water-Feed Supplies, Plus GFCI
- Includes Extendable Handle Bracket to provide extra leverage for easy cutting power



Kit includes: 9" Safety Guard, Loc-Line Assembly, Plastic Tie, 4 Plastic Collars, Adapter (1/4 NPT>>>M10*P.1.O), Water Hose Assembly, Memory Wrap (3ft. / 1M), Quick Connect Adapter, GFCI Plug (120V), Hook & Loop Tie & Screw w/Spring Lock Washer and Floor Cutting Kit (Part# 510000)

PART NO.	SIZE	TYPE	RECOMMENDED FOR	DESCRIPTION
WBC9KIT	9"	110V	7" & 9" High-Speed Angle Grinders	Wet Blade Cutting Kit
WBC9KIT2V	9"	220V	7" & 9" High-Speed Angle Grinders	Wet Blade Cutting Kit
510000			Cutting Applications	Extendable Handle Bracket

WET BLADE CUTTING KITS

CONVERT DRY GRINDER FOR WET CUTTING



- Designed To Convert A High-Speed Angle Grinder Into A Wet Tool
- Can Be Used On Most Grinders with Minimal Alterations
- Fits Most 4-1/2", 5" and 6" High-Speed Angle Grinders
- Kink-Free Water Hose for Easy Maneuverability and Reducing Operator Fatigue
- Save Money and Use Your Tool Wet or Dry!

Kit includes: Safety Guard, Loc-Line Assembly, Plastic Tie, Stainless Steel Collar, Plastic Collar, Adapter (1/4 NPT>>>M10*P.1.O), Water Hose Assembly, Memory Wrap (3ft. / 1M), Quick Connect Adapter, GFCI Plug (120V) & Hook & Loop Tie

PART NO.	SIZE	TYPE	RECOMMENDED FOR	DESCRIPTION
WBC5KIT	5"	110V	4-1/2", 5" & 6" High-Speed Angle Grinders	Wet Blade Cutting Kit
WBC6KIT	6"	110V	4-1/2", 5" & 6" High-Speed Angle Grinders	Wet Blade Cutting Kit
WBC5KIT2V	5"	220V	4-1/2", 5" & 6" High-Speed Angle Grinders	Wet Blade Cutting Kit
WBC6KIT2V	6"	220V	4-1/2", 5" & 6" High-Speed Angle Grinders	Wet Blade Cutting Kit

WET SANDING/ POLISHING KIT

CONVERTS DRY POLISHER / SANDER INTO A WET TOOL



- Designed To Convert A Dry Polisher Into A Wet Tool
- Save Money and Use Your Tool Wet or Dry!
- Quick Solution for OSHA Compliance
- Kit includes: Safety Guard, Loc-Line Assembly, Water Hose Assembly, Memory Wrap (3ft. / 1M), Quick Connect Adapter, GFCI Plug (120V) & Hook & Loop Strap

Kit includes: Safety Guard, Loc-Line Assembly, Water Hose Assembly, Memory Wrap (3ft. / 1M), Quick Connect Adapter, GFCI Plug (120V) & Hook & Loop Strap

PART NO.	TYPE	RECOMMENDED FOR	DESCRIPTION
WSPKIT	110V	Sanders & Polishers	Wet Sanding & Polishing Kit
WSPKIT2V	240V	Sanders & Polishers	Wet Sanding & Polishing Kit



Multi-Purpose Waterproof Apron - LONG SLEEVE



Rubber Cuffs

Customizable Cuff
with Easy
Cut Lines for a
Perfect Fit

Wet/Dry Use



REGULAR

Part # - APRON2LSR

SMALL

Part # - APRON2LSS

APRON

MULTI-PURPOSE
APRON



- Rubber Cuffs Provides Full Coverage
- Bright Neon Yellow Color Provides Greater Visibility
- Perfect for Wet or Dry Environments
- Protects From Dust, Water and Other Chemicals
- Dual-Adjustable Clips Makes For A Perfect Fit



Dual-Adjustable Clips Makes for a Perfect Fit

PART NO.	SIZE	TYPE	DESCRIPTION
APRON2LSR	55"L x 60" W (140cm L x 152cm W)	Long Sleeve	Multi-Purpose Waterproof Apron (Regular)
APRON2LSS	42"L X 41"W (107cm L x 104cm W)	Long Sleeve	Multi-Purpose Waterproof Apron (Small)

APRON

MULTI-PURPOSE
APRON SLEEVELESS



- Sleeveless with Wide Straps for Ease and Comfort
- Bright Neon Yellow Color Provides Greater Visibility
- Perfect for Wet or Dry Environments
- Protects From Dust, Water and Other Chemicals
- Dual-Adjustable Clips Makes For A Perfect Fit



Dual-Adjustable Clips Makes for a Perfect Fit

PART NO.	SIZE	TYPE	DESCRIPTION
APRON2000	55"L x 60" W (140cm L x 152cm W)	Sleeveless	Multi-Purpose Waterproof Apron (One Size Fits All)

DUST CARRIAGE

DUST CONTROL CARRIAGE SYSTEM



- Designed As A Support To Hold The Dust Bag When Cutting or Grinding
- Conveniently Pulls Behind The Tool So As Not To Interfere with The Job
- Front Swivel Wheels Allows for Easy Maneuvering
- Dust Bag Is Easily Secured To The Dust Carriage with Ties
- Recommended for Flat Surfaces

PART NO.	SIZE	TYPE	DESCRIPTION
ECO-CARS	5"	110V	Dust Bag Carriage (includes Dust Bag)
801392	16" x 13-1/2" X 8"		Dust Bag

GLOSS CHECKER



- Portable Gloss Meter Designed To Measure The Reflective Index Of Light
- Enables Quick, Accurate Measurements Of Gloss On Flat, Polished Surfaces
- Ensures Quality Control and Assists Setting Standards
- Detachable Meter for Difficult To Reach Areas
- Can Be Used Across Multiple Industries

PART NO.	DESCRIPTION
IG-331	Gloss Meter

SAFETY GLASSES



- Designed for Safety and Comfort
- A Lightweight Frame with Padded Temples
- Adjustable Side Arms
- Soft Rubber Nose Bridge
- Clear Anti-Scratch Lenses
- Available in a single pair or 12-pack
- Complies with standard # BS EN 166:2001

PART NO.	DESCRIPTION
173002	Safety Glasses (Box of 12)
173008	Safety Glasses (Single Pair)

GROUND FAULT CIRCUIT INTERRUPTER



- Protect Polishing Personnel From Lethal Ground Current Loads
- Highly Recommended Piece Of Equipment
- Rated for 15 Amps

PART NO.	DESCRIPTION	TYPE
GFCI-1	Ground Fault Circuit Interrupter	110V
GFCI-2	Ground Fault Circuit Interrupter	220V

EZ CLICK2 SYSTEM

TILE LEVELING SYSTEM FOR EDGES AND CORNERS

EZ Click2



Tightens and Releases by Hand
(No Tools Required)

- Designed for Wet Installation of 3/4" (2cm) Thick Pavers
- Instant Screw Ejection Leveling System
- Proprietary Scratch-Prevention Edge
- Built-in Spacer Calibration: 1mm and 4mm available
- Color Coded Base Screws for Easy Identification
- Cap Can Be Re-Used More Than 500 Times

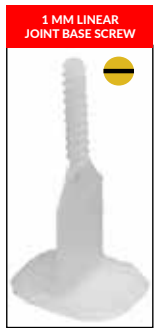

PART NO.	SIZE	TYPE	COLOR	QTY
EZCLICKCP		Screw Cap		50
EZCLB10W2	1/32" (1.0mm)	Linear Joint Base Screw	White	200
EZCLB40B2	5/32" (4.0mm)	Linear Joint Base Screw	Black	200

**INNOVATIVE
SOLUTIONS**

G-Tape
Multi-Purpose
Surface Protection
and Repair Tape

**Key Features
and Benefits**

- Hand Tearing-Straight and Easy
- Residue Free Removal
- Waterproof
- All-Weather Usage (-40°F to +200°F)
- Repositionable
- Highly Weather/UV Resistant
- Good Surface Protection
- Great for Quick Repairs
- Easily Mark Tape with Ball Point Pen, Permanent Marker, China Marker, etc.
- Available as a single roll or Case of 30 pcs.

LDPE film _____
 HDPE cloth _____
 LDPE film _____
 Acrylic PSA layer _____



All G-Tape™ products feature a patented combination of solvent acrylic adhesive with an advanced backing substrate that results in unmatched performance.

G-TAPE

**ALL PURPOSE
PROTECTION & REPAIR TAPE**

Nichigo G-Tape™ 1000 Series

Multi-Purpose Surface Protection and Repair Tape



- Hand Tearing-Straight and Easy
- Residue Free Removal
- Waterproof
- All-Weather Usage (-40°F to +200°F)
- Repositionable
- Highly Weather/UV Resistant
- Good Surface Protection
- Great for Quick Repairs
- Easily Mark Tape with Ball Point Pen, Permanent Marker, China Marker, etc.
- Available as a single roll or Case of 30 pcs.

PART NO.	COLOR	SIZE	BOND TYPE
1009CL-GT-2-164	Clear	2" x 164' (50mm x 50m)	Removable
1009GR-GT-2-164	Green	2" x 164' (50mm x 50m)	Removable
1006TG-GT-2-82	Black & Yellow	2" x 82' (50mm x 25m)	Removable

Nichigo G-Tape™ 1008 Series

Long Term Masking and Storage



- Surface Protection of Metallic Raw Materials In Outdoor Settings
- Long Term Masking For Painting And Welding
- Hand Tearing-Straight and Easy
- Scrap-Less: Face To Face Contact Of Adhesive Separates Without Damaging The Adhesive
- High Weather Resistance: Residue Free Removal Even After 6 Months
- Repositionable
- All-Weather Usage (-40°F to +200°F)

PART NO.	COLOR	SIZE	BOND TYPE
1008BK-GT-2-164	Black	2" x 164' (50mm x 50m)	Removable
1008SW-GT-2-164	White	2" x 164' (50mm x 50m)	Removable

G-TAPE

**ALL PURPOSE
PROTECTION & REPAIR TAPE**

Nichigo G-Tape™ 3035 Series

Self-Adhering Flashing Tape (Without Liner)



- Designed for Seaming, Splicing Of Insulation Sheets, House Wraps, And Wall Boards
- Easy To Tear By Hands Straight
- Perfect for Use As A Waterproofing Tape On Outdoor Deck's Rafter
- Great for Seaming, Splicing Around Window Frame
- Scrap-Less: Face To Face Contact Of Adhesive Separates Without Damaging The Adhesive
- Lightweight: 50 To 70% Lighter Than Conventional Window Flashing Tape
- Highly Weather/UV Resistant
- All-Weather Usage (-40°F to +200°F)
- Meets AAMA 711-13; Type A (without primer), Level 3 (exposure up to 176°F) and AC 148

PART NO.	COLOR	SIZE	BOND TYPE
3035BK-GT-2-65	Black	2" x 65' (50mm x 20m)	Permanent
3035BK-GT-3-65	Black	3" x 65' (75mm x 20m)	Permanent
3035BK-GT-4-65	Black	4" x 65' (100mm x 20m)	Permanent

Nichigo G-Tape™ 3040 Series

High Adhesion Acrylic Flashing Tape



- Perfect Flashing for Windows, Doors, & Deck Beams
- Hand Tearing-Straight and Easy
- Waterproof
- All-Weather Usage (-40°F to +200°F)
- AAMA 7-11 Level 3 Class A Certified
- Highly Weather/UV Resistant
- Permanent Adhesion
- Cleanly Removes from Face-to-Face Adhesive Contact
- Available as a single roll or by the case

PART NO.	COLOR	SIZE	BOND TYPE
3040BK-GT-2-65	Black	2" x 65' (50mm x 20m)	Permanent
3040BK-GT-4-65	Black	4" x 65' (100mm x 20m)	Permanent
3040BK-GT-6-65	Black	6" x 65' (150mm x 20m)	Permanent
3040BK-GT-9-65	Black	9" x 65' (225mm x 20m)	Permanent
3040BK-GT-12-65	Black	12" x 65' (300mm x 20m)	Permanent

G-TAPE

**ALL PURPOSE
PROTECTION & REPAIR TAPE**

Nichigo G-Tape™ 3045 Series

Self-Adhering Flashing Tape

LDPE laminating

HDPE cloth

LDPE laminating

Acrylic adhesive

Paper liner

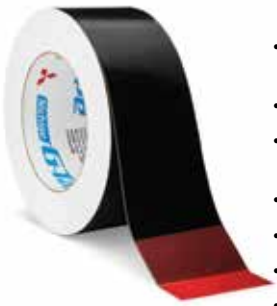
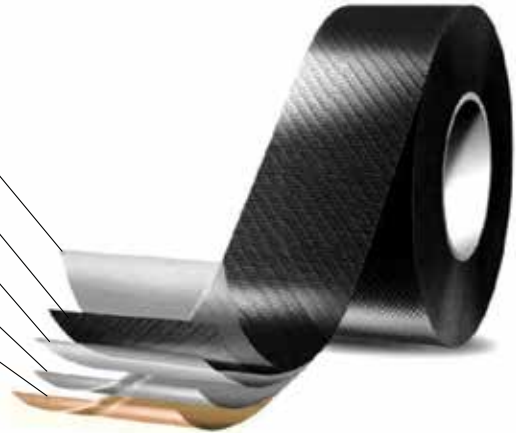

- Designed for Seaming Various Rubber Sheets with A High Static Shear To Rubber
- Excellent Adhesion To Rubber (Ex. Ethylene Propylene Diene (EPDM) Rubber)
- Easy To Tear By Hands Straight: No Cutting Tool Is Required
- Scrap-Less: Face To Face Contact Of Adhesive Separates Without Damaging The Adhesive
- Great Replacement For Asphalt Tape And/Or Butyl Tape
- Repositionable – No Wrinkles When Applied
- All-Weather Usage (-40°F to +200°F)
- Meets AAMA 711-13; Type A (without primer), Level 3 (exposure up to 176°F) and AC 148

PART NO.	COLOR	SIZE	BOND TYPE
3045BK-GT-2-65	Black	2" x 65' (50mm x 20m)	Permanent
3045BK-GT-3-65	Black	3" x 65' (75mm x 20m)	Permanent
3045BK-GT-4-65	Black	4" x 65' (100mm x 20m)	Permanent

Surface Protection

Repositionable Waterproof Surface Protection Tape



- Ideal For Masking For Concrete, Stucco, Mortars, And Bricks
- Easy To Tear By Hands Straight: No Cutting Tool Is Required
- High Weather Resistance: Residue Free Removal Even After 1 Month
- Scrap-Less: Face To Face Contact Of Adhesive Separates Without Damaging The Adhesive
- Using As A Line Tape And Caution Sign Tape
- Repositionable – No Wrinkles When Applied
- Perfect For A Quick Stick On Various Materials
- All-Weather Usage (-40°F to +200°F)
- Also Available in Blue and Red Upon Request

PART NO.	COLOR	SIZE	BOND TYPE
BAB0650	Black	6" x 164' (150mm x 50m)	Large Surface Protection
2010BK-GT-2-164	Black	2" x 164' (50mm x 50m)	Removable
2010BK-GT-6-164	Black	6" x 164' (150mm x 50m)	Removable

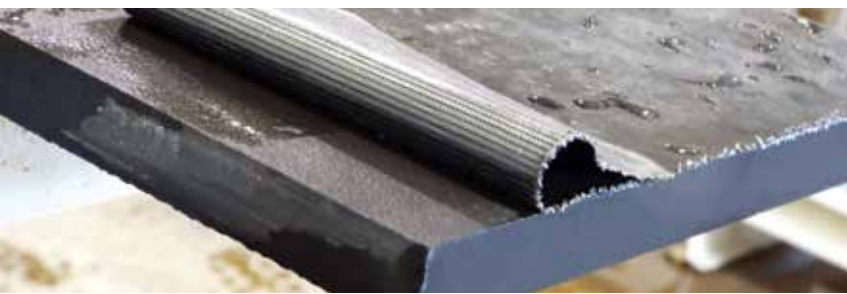

RSR-2000

RUST STAIN REMOVER IN GEL FORM



- Removes Common Rust Stains From Natural Stone Surfaces, Concrete, Brick, Terra Cotta, Mexican Tile, or Other Hard Porous Surfaces
- Specially Formulated To Work Extremely Fast
- Non-Hazardous Chemical Is Safe To Use and Will Not Harm The Environment
- Use On Floors, Countertops, Vertical Surfaces and Exterior Areas
- Available in 14oz Tube or Trial Size 1.4oz Bottle
- Tube Covers Approximately 4 sqft



PART NO.	SIZE	CONTAINER
RSR-400G	14 oz. (400g)	Tube
RSR-040G	1.4 oz. (40g)	Bottle

Index

A

AIR-680UW 15
Antique Brush Wheels 46
Apron 53

B

Blademaster 36

C

Ceramica EX 45
Contour
 Granite & Eng. Stone 33
 Porcelain/Cryst. Glass 32

D

Dressing Stick 37
Drill Bit Guide 43
Dry Core Bits 41
Dust Carriage 55

E

ECC-125 13
ECC-KIT 14
Eclipse II 24
Eclipse Q 25
Ecoguard Type C 47
Ecoguard Type CD 48
Ecoguard Type D 47
Ecoguard Type G 48
Ecoguard Type W Series 49
Electroplated Drill Bits 42
ESC-125
 5" Wet/Dry Stone Cutter 6
 Countertop Trim Kit 8
ESC-150
 6" Wet/Dry Stone Cutter 9
 Countertop Trim Kit 12
 Miter Cutting Kit 11
EZ Click System 56

F

Flexible Backer Pad 50

G

Gloss Checkers 55
Ground Fault
 Circuit Interrupter 55
G-Tape 57, 58, 59, 60, 61
GV Backer Pads 50

H

Hand Pads 44
Hot-Rod 34

K

Katana 25

P

Plasterking Resin 16
Plus 23
Porcellana 28
Porcellana For PRS 28
Profilers
 B-Series 38
 V-Series 39
 Z-Series 38
PSC-150 Miter Cutting Kit 11
PT Cutter 35

Q

Q-Cut 27
Quad 24
Quad Adapters 37

R

Rescue 36
Rigid Backer Pad 50
Rotary Backer Pad 19
RSR-2000 62

S

Sandpaper 45
Spike Disc 40
Spike Ruler 37

T

Tile Bullnose Kit 21

U

Ultracut
 APR Series 31
 GPM Series 26
Ultracut APR Series 31
Ultracut GPM Series 26

V

Vacuum Brazed
Trimmer Bit 42
VDP-700 17
 Rotary Backer Pad 19
 Wool Pads 19
Vetro 29
Vetro For PRS 29
Vortex
 For Granite 30
 For Marble 30
VSP-320 20

W

WBC9KIT 51
Wet Blade Cutting Kit 51, 52
Wet Core Bits 41
Wet Sanding/Polishing Kit 52
Wool Pads 19

Product Literature

Catalogs

Alpha® provides product catalogs for all products to best serve the particular needs of our customers. Catalogs are available for applications such as Hand Tooling and Large Machine Tooling, as well as for specific industries such as stone, tile, construction, industrial, automotive, composites, glass and marine.

All of our catalogs are a convenient portable of size 5.5" x 8.5", and illustrate the tools and accessories needed for Cutting, Profiling, Grinding, Drilling, Polishing and Restoring all types of materials.

To request these catalogs, or for more information about our product line, visit our website at www.alpha-tools.com or contact us at 800-648-7229.



ALPHA® TOOL REPAIR

- Authorized repair centers available
- All tool repairs carry a 30-day warranty
- Quick turn-around time
- Technical support for repair and maintenance
- Order replacement tool parts directly from Alpha®
- Loaner program available

Visit our website to find a local center



Let's get social...



We are ready to connect with you on your favorite social media sites... Join Us Today!

 **Alpha Professional Tools®**

16 Park Dr Ste 9, Franklin, NJ 07416
800-648-7229 • Fax: 800-286-0114

www.alpha-tools.com

