

ALPHA®

TOOLS FOR
**HARDSCAPE
CONTRACTORS**

PROVIDING BETTER
SOLUTIONS
TO THE
PROFESSIONAL



VERSION 5



WELCOME

Alpha Professional Tools® was founded in 1986 and has become a leading manufacturer of quality tools for professionals in the natural/engineered stone, porcelain, ceramic, glass, construction, marine and automotive industries. Alpha® provides the best products for cutting, drilling, shaping and polishing all types of materials.

In addition to providing the best products in the industry, Alpha Professional Tools® offers a variety of services to support their products.

Company Contact Information:

Headquarters & Training Center:	103 Bauer Drive Oakland, NJ 07436
Hours of Operation (EST):	8:30 a.m. - 5:00 p.m.
Telephone No:	201-337-3343
Toll-Free No:	800-648-7229
Fax No:	201-337-2216
Customer Service Fax No:	800-286-0114
Tool Dept. Fax No:	201-337-2265
Accounting Dept. Fax No:	201-337-2262

E-mail Orders to:

orderdesk@alpha-tools.com
tooldesk@alpha-tools.com

Contact Us:

www.alpha-tools.com
info@alpha-tools.com

Follow Us:



Sales Contacts by Territory – sales@alpha-tools.com

Caribbean	201-337-3343	Northern CA	925-428-1292
Canada	519-546-9861	Northwest	800-648-7229
Central Plains	800-648-7229	NY Metro	973-830-7681
Florida	786-570-4350	Ohio Valley	440-364-3759
International	201-337-3343	Pacific	800-648-7229
Mid-Atlantic	804-382-5357	South	713-252-9851
Midwest	630-849-7105	Southeast	678-977-1147
Mountain	480-848-6808	Southern CA	714-853-3476
New England	860-933-6626		

TOOLS

GRINDERS

- PSG-658, High-Performance Pneumatic Grinder 6

STONE CUTTER

- PSC-600, High-Performance Pneumatic Stone Cutter 8
- ESC-125, Wet/Dry Stone Cutter 10
- Countertop Trim Kit 12
- ECC-125, Virtually Dust-Free Cutting Solution 13
- ECC-KIT, Dry Porcelain Paver Tile Cutting System 14

POLISHERS

- AIR-300 15
- AIR-830 / 850, High-Performance Pneumatic Polishers 16
- VDP-700, Variable Speed Rotary Polisher 18
 - Wool Pads 20
 - Rotary Backer Pads 20
- VSP-320, Variable Speed Wet Polisher 21

POLISHING KITS

- Paver Tile Bullnose Kit 22

CUTTING

DRY BLADES

- Plus 24
- Quad 24
- Eclipse II 25
- Eclipse Q 25
- Katana 26
- Ultracut GPM 26

WET BLADES

- Q-Cut 27
- Porcellana 28
- Porcellana PRS 28
- Vetro 29
- Vetro PRS 29

FLUSH CUTTING BLADES

- Vortex for Granite 30
- Vortex for Marble 30
- Ultracut APR 31

CURVE CUTTING BLADES

- Contour for Porcelain/Crystallized Glass 32
- Contour for Granite 33
- Contour for Marble 33

CHANNEL CUTTING BLADES

- Hot-Rod Blade 34

DEMOLITION SAW BLADES

- PT Cutter 35
- Blade Master 36
- Rescue Blade 36

BLADE ACCESSORIES

- Quad Adapters 37
- Flange Adapters 37
- Spike Ruler 37
- Dressing Stick 37

TABLE OF CONTENTS

PROFILING

PROFILERS

- Profiler B-Series 39
- Profiler Z-Series 39
- Profiler V-Series 40

DRILLING

CORE DRILL BITS

- Wet Core Bits 42
- Dry Core Bits 42

TRIMMER BITS

- Vacuum Brazed Trimmer Bit 43

DRILL BITS

- Electroplated Drill Bits 43

DRILL BIT ACCESSORIES

- Drill Bit Guide 44

POLISHING

DIAMOND PADS

- Diamond Hand Pads 46
- Ceramica EX 47
- Sandpaper 47

POLISHING WHEELS

- Antique Brush Wheels 48

ACCESSORIES

DUST-FREE GUARDS

- Ecoguard C 50
- Ecoguard D 50
- Ecoguard CD 51
- Ecoguard G / G7 51
- Ecoguard W5 / W6 / W9 52

BACKER PADS

- Rigid Backer Pads 53
- Flexible Backer Pads 53
- GV Backer Pads 53

MISCELLANEOUS

- Ground Fault Circuit Interrupter 54
- Safety Glasses 54
- Rust Inhibitor Oil 54
- Manifold System 55
- Hoses 56
- Wet Blade Cutting Kit 58
- Wet Polishing and Sanding Kit 59
- Pool Coping Kit 60
- Aprons 61
- G-Tape 63
- EZ Click System 66
- Stain Removers 66

TOOLS

High-performance tools,
designed for use in the
construction industry



PSG-658

HIGH-PERFORMANCE PNEUMATIC GRINDER

Newly developed motor produces more power

Lightweight For Better Maneuverability

Spring Return Throttle to Avoid Accidental Start

Enhanced Spindle Shaft for Easy Tool Removal
(Wrench Included)

Newly Developed Motor Produces More Power

8,500 RPM

Composite End Case to Prevent Freezing Hands

15ft. All-Weather Hoses with Flexibility Down To -40°F Or +140°F (-40°C To +60°C)

Optional C-Handle



Part No 1030-0004



Water Quick Coupler w/ Shut Off Valve

PSG-658

HIGH-PERFORMANCE PNEUMATIC GRINDER



- Center Water-Feed System to Deliver Ample Water Regardless of Position
- 15ft. All-Weather Hoses with Flexibility Down To -40°F Or +140°F (-40°C To +60°C)
- Newly Developed Motor Produces More Power
- Lightweight and Ergonomically Designed for Better Maneuverability
- Composite End Case to Prevent Freezing Hands
- Silicon Gear Head Cover Provides Cushion and Keeps Hands Warm
- Enhanced Spindle Shaft for Easy Tool Removal (Wrench included)
- One Year Warranty (See manual for details)

SPECIFICATION	DATA
Model	PSG-658
Air Pressure	85 PSI (6 Bar)
Air Consumption	15 CFM (425L/min)
Weight	2.9 lbs (1.3 kgs)
No Load RPM	8,500 RPM
Air Inlet	1/4" BSPP
Water Inlet	1/8" BSPP
Spindle	5/8"-11
Cutting Disc Diameter	6" (150mm)
Length	7-1/2" (190.5mm)

ITEM	QUANTITY
Air Hose (15ft / 4.5m)	1
Water Hose (15ft / 4.5m)	1
Side Handle (reversible)	1
Rust Inhibitor Oil (6.7oz/200ml)	1
Screw (w/O-Ring Seal for Oil Port)	1
Exhaust Hose & Clamp	1
Spring Washer	1
6" Safety Guard	1
Double End Wrench (19mm/22mm)	1
Phillips Screwdriver	1
Water Quick Coupler w/Shut-off Valve	1
O-Ring (O-Ring for Water Valve Repair)	1
Hex Wrench (6mm)	1

PART NO.	MAXIMUM RPMS	RECOMMENDED FOR	DESCRIPTION
PSG-658	8,500	Grinding	Pneumatic Grinder
AIR-008		Pneumatic Tools	Rust Inhibitor Oil 8oz (237ml)

PSC-600

High-Performance Pneumatic Cutter/Grinder

*Winning Combinations
Without the Dust!*



CUTTER/GRINDER

PSC-600

HIGH-PERFORMANCE PNEUMATIC CUTTER



- Center Water-Feed System to Deliver Ample Water Regardless of Position
- 15ft. All-Weather Hoses with Flexibility Down To -40°F Or +140°F(-40°C To +60°C)
- Newly Developed Motor Produces More Power
- Lightweight and Ergonomically Designed for Better Maneuverability
- Composite End Case to Prevent Freezing Hands
- Silicon Gear Head Cover Provides Cushion and Keeps Hands Warm
- Enhanced Spindle Shaft for Easy Tool Removal (Wrench included)
- One Year Warranty (See manual for details)

SPECIFICATION	DATA
Model	PSC-600
Air Pressure	85 PSI (6 Bar)
Air Consumption	15 CFM (425L/min)
Weight	2.9 lbs (1.3 kgs)
No Load RPM	8,500 RPM
Air Inlet	1/4" BSPP
Water Inlet	1/8" BSPP
Arbor	7/8" (22mm)
Cutting Disc Diameter	6" (150mm)
Length	7-1/2" (190.5mm)

ITEM	QUANTITY
Air Hose (15ft / 4.5m)	1
Water Hose (15ft / 4.5m)	1
Side Handle (reversible)	1
Rust Inhibitor Oil (6.7oz/200ml)	1
Screw (w/O-Ring Seal for Oil Port)	1
Exhaust Hose & Clamp	1
Spring Washer	1
6" Safety Guard	1
Double End Wrench (19mm/22mm)	1
Phillips Screwdriver	1
Water Quick Coupler w/Shut-off Valve	1
O-Ring (O-Ring for Water Valve Repair)	1
Single Open End Wrench (22mm)	1
Hex Wrench (6mm)	1
Inner Flange for Cutting	1
Outer Flange	1
L-Bracket	1
Inner Flange for Grinding	1

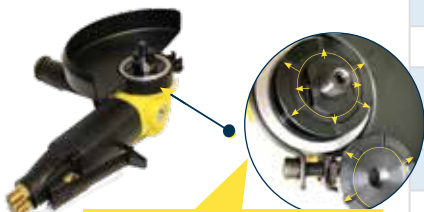

Center Water-Feed System to Deliver Ample Water Regardless of Position

PART NO.	MAXIMUM RPMS	RECOMMENDED FOR	DESCRIPTION
PSC-600	8,500	Cutting	Pneumatic Stone Cutter
AIR-008		Pneumatic Tools	Rust Inhibitor Oil 8oz (237ml)

STONE CUTTER

Introducing A New and Improved
Version of Our Popular **AWS-125...**

ALPHA[®]

ESC-125

WET/DRY STONE CUTTER

OSHA[®]
COMPATIBLE

DRY

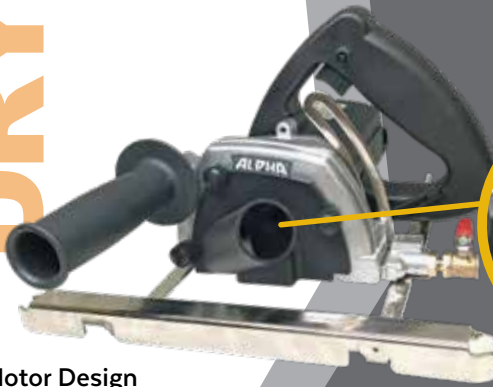

Dust Cover For HEPA
Vacuum Connection

- New Motor Design
- Kink Free Hybrid Water Supply Hose with Quick Change Connector

WET



Newly Designed
Water Jet

*Blade not included

Quick Change
Connector



GUIDE RAIL



(optional)

ASC-5CSM

ESC-125

WET/DRY STONE CUTTER



- Precision Cuts Everytime
- Powerful Motor For Use On Porcelain Paver Tile, Granite, Quartz Surfaces, Marble, Limestone, Concrete and Sintered Slabs
- Water-Feed Supply Eliminates The Harmful Dust Particles
- Base Plate Allows Guides To Be Used in Multiple Ways
- Dust Cover for HEPA Vacuum Connection
- New Clamping System Ensures Cutting Stability
- Included Self-Stick Felt Strips Protects The Work Surface From Scratches
- Built-In GFCI (Ground Fault Circuit Interrupter)
- Great For Use With Curve Cutting Blades
- One Year Warranty (*See manual for details*)

SPECIFICATION	DATA
Model	ESC-125
Rating	110 Volts
Amperage	11.2A
Power	1200W
No Load Speed (min-1)	12,000 RPM
Weight	8.9 lbs (4.0 kgs)
Arbor	7/8" (22.23mm)
Cutting Disc Diameter	5" (125mm)
Plug Type	A (110V)
Cord	15ft (4.5m) Single-Phase
Max. Cutting Depth	1-5/8" (41mm)

ITEM	QUANTITY
Dust Cover	1
Knob Bolt	3
TT Ruler Guide	1
Water Hose Assembly	1
Quick Connect Adapter	1
Side Handle	1
Screw (M6x30-Left)	1
Flange 3	1
Carbon Brush Set	1
T-Handle Wrench	1
Open-End Wrench (22mm)	1
Self-stick Felt Strip Set	1
GFCI	1
EasyOn-EasyOff Sleeve	1
SS Flat Head Screw (M4x10)	3
Water Valve Assembly	1

PART NO.	SIZE	TYPE	ARBOR(S)	DESCRIPTION
ESC-125	5"	110V	7/8" (22.23mm)	Wet/Dry Stone Cutter

COUNTERTOP TRIM KIT

COMPLETE TRIM KIT
FOR A CUSTOM-LOOK

Part number: 5480-4150



COUNTERTOP TRIM KIT



Complete Trim Kit for a Custom Look

INCLUDES:

Wet/Dry Stone Cutter
ESC-125

5" Eclipse Blade
DEE005

5" Carriage Assembly
for Stone Cutter
ASC-5CSM

4' Guide Rail with Clamps
ASC-GR04

- Recommended for Hard Surfaces
- Eclipse II Blade has 8mm Tall Diamond Layer for a Long Life
- Perfect for your Stone Tile Application
- High-End General Purpose Turbo Blade for Stone Fabricators
- Consistent Performance without Chipping
- Kit Contains: ESC-125 Stone Cutter, 5" Carriage Assembly, 5" Eclipse II Blade and 4' Guide Rail
- One Year Tool Warranty (*See manual for details*)

PART NO.	DESCRIPTION
5480-4150	Countertop Trim Kit (ESC-125)

STONE CUTTER

ECC-125

ECOCUTTER



- Virtually Dust-Free
- Portable Cutting System
- Accurate Cutting Performance
- Eliminates Downtime
- Built-in In-line circuit breaker
- Great for Grout Removal, Crack Chasing & Concrete Profiling
- One Year Warranty (*See manual for details*)

SPECIFICATION	DATA
Model	ECC-125
Rating	110 Volts
Amperage	11.2A
Power	1200W
No Load Speed (min-1)	12,000 RPM
Weight	9.5 lbs (4.3 kgs)
Arbor	7/8" (22.23mm)
Cutting Diameter	5" (125mm)
Maximum Cutting Depth	1-1/8" (29mm)

ITEM	QUANTITY
Dust Hose	1
Dust Gate	1
Side Handle	1
Hexagon Ring Spanner	1
Wrench	1
Dust Bag	1
TT Ruler	1
Hook & Loop Strap	2

PART NO.	SIZE	TYPE	ARBOR(S)	DESCRIPTION
ECC-125	5"	110V	7/8" (22.23mm)	Ecocutter
133544	17" x 13-1/2" x 12"			Dust Bag w/strap
ECO-CARS		Steel		Dust Bag Carriage (includes Dust Bag)

DUST BAG CARRIAGE



CUTTING KIT

ECC-KIT

DRY PORCELAIN PAVER TILE CUTTING SYSTEM

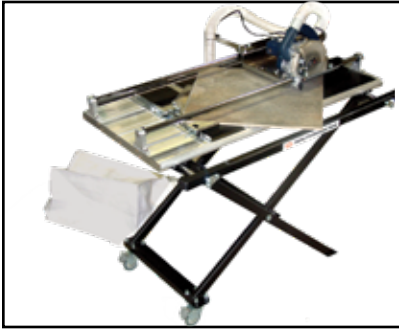

- Virtually Dust-Free
- Portable Cutting System
- Accurate Cutting Performance
- Eliminates Downtime and The Messy Cleanup
- Built-In Breaker Assembly
- Holds 3/4" Thick Porcelain Paver Tile
- One Year Tool Warranty (*See manual for details*)

SPECIFICATION	DATA
Model	ECC-KIT (ECC-125)
Rating	110 Volts
Amperage	11.2
Power	1200W
No Load Speed (min-1)	12,000 RPM
Weight	9.5 lbs (4.3 kgs)
Arbor	7/8" (22.23mm)
Cutting Diameter	5"(125mm)
Maximum Cutting Depth	1-1/8" (29mm) (without Ecocutter Table)

EQUIPMENT INCLUDED	QUANTITY
ECC-125	1
Dust Hose	1
Dust Gate	1
Side Handle	1
Hexagon Ring Spanner	1
Wrench	1
Dust Bag	1
TT Ruler Guide	1
Hook & Loop Strap	2
Ecocutter Table	1
Ecocutter Stand	1
Alpha® Ultracut GPM Blade 5"	1
Basic Instructional DVD	1

PART NO.	SIZE	TYPE	ARBOR(S)	DESCRIPTION
ECC-KIT	5"	110V	7/8" (22.23mm)	Dry Cutting System
ECC-125	5"	110V	7/8" (22.23mm)	Ecocutter
133544	17"x13-1/2 x 12"			Dust Bag w/strap
ECC-STAND				Dry Cutting System Stand
ECC-TABLE				Dry Cutting System Table
170005				Ecocutter DVD
PART NO.	SIZE	THICKNESS	MAX RPM	ARBOR(S)
GPM0578	5"	1.5mm	12,200	7/8"

AIR-300

MINI PNEUMATIC POLISHER



- High-Performance, Pneumatic Polishing Tool with A Central Water-Feed System
- No-Load 5,800 RPMs
- Lightweight and Ergonomically Design Reduces Fatigue
- Designed To Easily Maneuver in Small Areas Like Sink Rims and Bowls
- Consumes 10 CFM and Requires 87 PSI
- Only Requires 3HP Compressor
- One Year Warranty (*See manual for details*)

SPECIFICATION	DATA
Model	AIR-300
Air Pressure	87 PSI (0.6Mpa (6 bar))
Air Consumption	10 CFM (280L/Min)
No Load Speed	5,800 RPM
Weight	1.6 lbs / .731 kgs
Air Inlet	1/4" BSPT
Water Inlet	1/4" BSPP
Spindle	5/8"-11



ITEM	QUANTITY
Air Hose 10ft (3m)	1
Water Hose 10ft (3m)	1
Faucet/Garden Hose Adapter	1
Wrench (17mm)	1
Rust Inhibitor Oil (1oz / 30cc) (Replace with: AIR-008)	1



PART NO.	MAXIMUM RPM	RECOMMENDED FOR	DESCRIPTION
AIR-300	5,800	Wet Polishing	Mini Pneumatic Polisher
AIR-008		Pneumatic Tools	Rust Inhibitor Oil 8oz (237ml)

Ergonomic and lightweight for better maneuverability

AIR-830



FEATURES:

- *Newly Developed Motor Produces More Power*
- *Silicon Gear Head Cover Provides Cushion and Keeps Hands Warm*
- *New Splash Guard Allows for Better Visibility Without Being Splashed*
- *Enhanced Spindle Shaft for Easy Tool Removal (Wrench Included)*
- *One Year Warranty (See manual for details)*

AIR-850

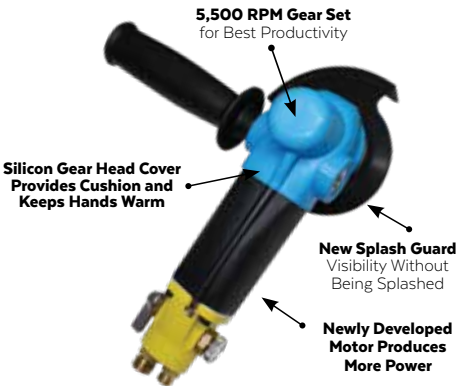

ITEMS INCLUDED:

ITEM	QUANTITY
Air Lead Hose 15ft. (4.5m)	1
Water Hose 15ft. (4.5m)	1
Side Handle (reversible)	1
Rust Inhibitor Oil (6.7oz / 200ml)	1
Screw (w/ O-Ring Seal for Oil Port)	1
Exhaust Hose with Clamp	1
Spring Washer	1
Splash Guard	1
Double End Wrench (19mm / 22mm)	1
Phillips Screwdriver	1
Water Quick Coupler w/ Shut-off Valve	1
O-Ring (O-Ring for Water Valve Repair)	1

AIR-830 / AIR-834

**HIGH-PERFORMANCE
PNEUMATIC POLISHER**



AIR-830

4,000 RPM Gear Set
for Best Quality Results

SPECIFICATION	DATA
Model	AIR-830/AIR-834
Air Pressure	85 PSI (6 Bar)
Air Consumption	15 CFM (425L/min)
Weight	2.75 lbs (1.2 kgs)
No load Speed	4,000 RPM
Air Inlet	1/4" BSPP
Water Inlet	1/8" BSPP
Spindle	5/8"-11 / M14-2

PART NO.	MAXIMUM RPM	THREADS	RECOMMENDED FOR	DESCRIPTION
AIR-830	4,000	5/8"-11	Wet Polishing, Drilling & Profiling	Pneumatic Polisher
AIR-834	4,000	M14-2	Wet Polishing, Drilling & Profiling	Pneumatic Polisher
AIR-008			Pneumatic Tools	Rust Inhibitor Oil 8oz (237ml)

AIR-850 / AIR-854

**HIGH-PERFORMANCE
PNEUMATIC POLISHER**



AIR-850

5,500 RPM Gear Set
for Best Productivity

SPECIFICATION	DATA
Model	AIR-850/AIR-854
Air Pressure	85 PSI (6 Bar)
Air Consumption	15 CFM (425L/min)
No load Speed	5,500 RPM
Weight	2.75 lbs (1.2 kgs)
Air Inlet	1/4" BSPP
Water Inlet	1/8" BSPP
Spindle	5/8"-11 / M14-2

PART NO.	MAXIMUM RPM	THREADS	RECOMMENDED FOR	DESCRIPTION
AIR-850	5,500	5/8"-11	Wet Polishing, Drilling & Profiling	Pneumatic Polisher
AIR-854	5,500	M14-2	Wet Polishing, Drilling & Profiling	Pneumatic Polisher
AIR-008			Pneumatic Tools	Rust Inhibitor Oil 8oz (237ml)

VDP-700

VARIABLE SPEED ROTARY POLISHER



VDP-700

WET/DRY VARIABLE SPEED ROTARY POLISHER



- Variable Speed 700-3500 RPM with Soft Start
- Designed For The Polishing Professional
- Heavy-Duty Precision Gear System
- Powerful 11.0 Amp (rated) Motor
- Built-in Speed Stabilizer for Constant Speed Output
- Configured with A Long-life Motor and Carbon Brushes
- 25ft. 14 AWG Electrical Power Cord
- Lightweight for Better Manueverability
- Industrial Quality Polisher
- C-Handle & Side Handle for User Convenience
- One Year Warranty (*See manual for details*)

SPECIFICATION	DATA
Model	VDP-700
Rating	120 Volts
Amperage	11.0A
Power	1250W (Rated), 1900W (Maximum)
No Load Speed (Variable)	700~3500 RPM w/Soft Start
Weight	6.4 lbs (2.9 kgs)
Spindle	5/8"-11
Power Supply	Single-phase AC, 50/60Hz
Plug Type	A (120V)
Cord	25ft (7.6m) (14 AWG)
Backing Plate Size	7" (178mm) (Maximum)
Polishing Disc Size	9" (228mm) (Maximum)

ITEM	QUANTITY
Spanner Wrench	1
Hex Wrench	1
C-Handle w/Mounting Screws	1
Side Handle	1
Extra Carbon Brush Set	1



PART NO.	SIZE	MAXIMUM RPM	TYPE	DESCRIPTION
VDP-700	7"	700-3500	120V	Variable Speed Rotary Polisher

**WET SANDING/
POLISHING KIT**

KIT Part # WSPKIT



WOOL PADS

REMOVES DEEP SCRATCHES WITH EASE



- Premium Performance and Heat-Resistant
- Smoother Handling and Reduced Vibration
- For Use on Rotary Polishers

PART NO.	SIZE	TYPE	RECOMMENDED FOR	MATERIAL	GRIT
WP003160	3"	Hook & Loop	Heavy Cutting	High-Nap Knitted Wool	T160
WP006160	6"	Hook & Loop	Heavy Cutting	High-Nap Knitted Wool	T160
WP007160	7"	Hook & Loop	Heavy Cutting	High-Nap Knitted Wool	T160

ROTARY BACKER PAD

FOR USE ON ROTARY POLISHERS



- Soft Molded Urethane With Flexible Edge
- Urethane Backing Makes for Greater Flexibility and Excellent Polishing
- Ideal for Contour Polishing
- For Use with Foam, Wool & Microfiber Pads
- Hook & Loop Allows for Fast Pad Changes
- Well Balanced for Smooth Polishing
- Absorbs Vibrations and Has Great Rebound Performance



Hook & Loop



Adhesive

PART NO.	SIZE	TYPE	RECOMMENDED FOR	THREADS
MP358HL	3"	Hook & Loop	Foam, Wool & Microfiber Pads	5/8"-11
MP558HL	5"	Hook & Loop	Foam, Wool & Microfiber Pads	5/8"-11
MP658HL	6"	Hook & Loop	Foam, Wool & Microfiber Pads	5/8"-11
MP758HL	7"	Hook & Loop	Foam, Wool & Microfiber Pads	5/8"-11
MP858HL	8"	Hook & Loop	Foam, Wool & Microfiber Pads	5/8"-11
MP858GL	8"	Adhesive	Foam, Wool & Microfiber Pads	5/8"-11

VSP-320

VARIABLE SPEED WET POLISHER



- Variable Speed 700-2500 RPM
- Heavy-Duty Gear System with Step-Down Transmission
- 15ft. Flexible All-Weather Water Hose
- 15ft. Electrical Power Cord Has An Inline GFCI
- EasyOn-EasyOff Sleeve Improves Maneuverability
- Adjustable Splash Guard
- Center Water-Feed System
- Ventilation Cap Diverts Water from Getting Into Motor Housing
- C-Handle & Side Handle for User Convenience
- One Year Warranty (See manual for details)

SPECIFICATION	DATA
Model	VSP-320
Rating	120 Volts
Amperage	7.0A
Power	800W
No Load Speed (Variable)	700~2500 RPM
Weight	7.3 lbs (3.3 kgs)
Spindle	5/8"-11
Power Supply	Single-phase AC, 50/60Hz
Plug Type	A (120V)
Cord	15ft (4.5m)
Polishing Disc Size	4" (100mm)

PART NO.	TYPE	DESCRIPTION
VSP-320	120V	Variable Speed Wet Polisher



ITEM	QUANTITY
Ground Fault Circuit Interrupter*	1
Flexible Hose w/ Garden Hose Adapter*	1
Wrench	1
C-Handle w/ Mounting Screws*	1
Side Handle (Reversible)	1
Extra Carbon Brush Set	1
Ventilation Cap w/ Rubber Band*	1
Splash Guard w/ Clamp	1
EasyOn-EasyOff Sleeve*	1

*Factory Attached



PAVER TILE BULLNOSE KIT

CREATES A FACTORY FINISH ON-SITE



- Designed To Create A Bullnose Edge On Tile or Stone and Polish It To A Factory Quality Finish
- Goof-Proof Hand-Held Application
- Quality Finish Without The Factory
- Save Time and Money
- Has Everything You Need
- Kit Contains: VSP-320 Polisher, Profiler V, 4" Ceramica EX Polishing Discs, 4" Flexible Backer Pad and Apron
- One Year Tool Warranty (See manual for details)



KIT INCLUDES:
 VSP-320, PFV201, GP45/8PD, EX40200R,
 EX40500R, EX41000R, EX42000R, EX43000R
 and APRON2000

PART NO.	DESCRIPTION
5480-1230	Paver Tile Bullnose Kit (VSP-320)

CUTTING

Premium blades for all your cutting needs.



PLUS

ULTIMATE DRY BLADE FOR BLUE STONE



- Best Dry Cutting Turbo Blade on the Market
- Perfect for Blue Stone, Granite, and Other Hard to Cut Materials
- 8mm Tall Diamond Layer for a Long Life
- Recommended for Hard Concrete
- Chip-Free Cutting on Most Demanding Applications

PART NO.	SIZE	THICKNESS	MAXIMUM RPM	ARBOR(S)
DA04A+	4"	2.1mm	14,500	20mm, 5/8"
DA05A+	4-1/2"	2.1mm	13,200	7/8", 20mm
DA05S	5"	2.1mm	12,200	7/8"
DA06A+	6"	2.1mm	10,100	7/8", 5/8", ⚡
DA07A+	7"	2.3mm	8,400	5/8", ⚡
DA08A+	8"	2.3mm	7,400	5/8", ⚡
DA09A+	9"	2.3mm	6,600	7/8", 5/8"
DA10A+	10"	2.5mm	5,900	1", 5/8"
DA11A+	10"	2.5mm	5,900	5/8"
DA12A+	12"	2.5mm	6,200	1", 20mm
DA13A+	12"	2.5mm	6,200	20mm

QUAD

ULTIMATE DRY FLUSH CUTTING BLADE



- Requires Quad Drive to fit High-Speed Angle Grinder
- Fits most popular High-speed Angle Grinders
- Specially Designed for Flush Cutting
- Best Dry Cutting Turbo Blade on the Market
- Chip-Free Cutting on Most Demanding Applications



PART NO.	SIZE	THICKNESS	MAXIMUM RPM	ARBOR(S)	THREADS
DA04AH	4"	2.1mm	14,500	20mm Quad Drive	
DA05SH	5"	2.1mm	12,200	20mm Quad Drive	
DA06AH	6"	2.1mm	10,100	20mm Quad Drive	
DA07AH	7"	2.3mm	8,400	20mm Quad Drive	
DA08AH	8"	2.3mm	7,400	20mm Flange with 8 holes	
DA09AH	9"	2.5mm	6,600	20mm Flange with 8 holes	
DA11AH	10"	2.5mm	5,900	20mm Flange with 8 holes	
AAH-20		Aluminum Adapter		20mm	5/8"-11
BAH-5/8		Brass Adapter		20mm	5/8"-11

ECLIPSE II

HIGH PERFORMANCE DRY BLADE



- High-End General Purpose Turbo Blade for Stone Fabricators
- 8mm tall Diamond Layer for a Long Life
- Perfect for your Stone Tile Application
- Consistent Performance without Chipping
- Recommended for Hard Concrete

PART NO.	SIZE	THICKNESS	MAXIMUM RPM	ARBOR(S)
DEE004	4"	2.1mm	14,500	20mm, 5/8"
DEE045	4-1/2"	2.1mm	13,200	7/8", 20mm
DEE005	5"	2.1mm	12,200	7/8"
DEE006	6"	2.1mm	10,100	7/8", 5/8", ⚡
DEE007	7"	2.3mm	8,400	5/8", ⚡
DEE008	8"	2.3mm	7,400	5/8", ⚡

ECLIPSE Q

HIGH PERFORMANCE DRY FLUSH CUTTING BLADE



- Requires Quad Drive or Flange Adapter to fit High-Speed Angle Grinder
- 8mm tall Diamond Layer for a Long Life
- Specially Designed for Flush Cutting
- High-End General Purpose Turbo Blade for Stone Fabricators
- Consistent Performance without Chipping



PART NO.	SIZE	THICKNESS	MAXIMUM RPM	ARBOR(S)	THREADS
DEQ004	4"	2.1mm	14,500	20mm Quad Drive	
DEQ005	5"	2.1mm	12,200	20mm Quad Drive	
DEQ578	5"	2.1mm	12,200	7/8" Quad Drive	
DEQ006	6"	2.1mm	10,100	20mm Quad Drive	
DEQ678	6"	2.1mm	10,100	7/8" Quad Drive	
DEQ007	7"	2.3mm	8,400	20mm Quad Drive	
DEQ008	8"	2.3mm	7,400	20mm Flange with 8 holes	
AAH-7/8		Aluminum Adapter		7/8"	5/8"-11
AAH-20		Aluminum Adapter		20mm	5/8"-11
BAH-5/8		Brass Adapter		20mm	5/8"-11

KATANA

ULTIMATE DRY BLADE FOR ALL TILES



- Tile Installer's Choice for Dry Cutting
- Specially Designed for 3/8" Hard Porcelain Tile
- Best Dry Cutting Tile Blade with Minimal Chipping
- Hybrid Dry Saw Blade for All Tiles
- Can Be used Wet or Dry

PART NO.	SIZE	THICKNESS	MAXIMUM RPM	ARBOR(S)
DPT100	4"	1.4mm	14,500	20mm, 5/8"
DPT115	4-1/2"	1.4mm	13,200	7/8", 20mm
DPT125	5"	1.4mm	12,200	7/8"
DPT150	6"	1.4mm	10,100	7/8", 5/8", ◀

ULTRACUT GPM

VACUUM-BRAZED DIAMOND BLADE



- Perfect for 2cm Porcelain Paver Tile
- Cuts most materials without chipping or cracking
- Maintains excellent cutting performance at the maximum cutting depth
- Great for building contractors and fabricators who work with metal and composite materials
- Fits on most popular hand-held electric power tools

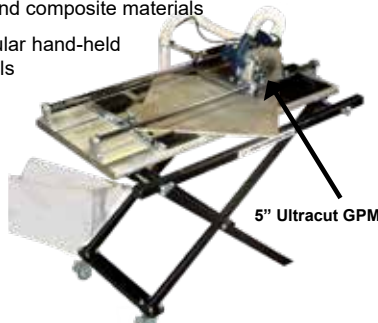

PART NO.	SIZE	THICKNESS	MAXIMUM RPM	ARBOR(S)
GPM0420	4"	1.5mm	14,500	20mm, 5/8"
GPM4578	4-1/2"	1.5mm	13,200	7/8", 20mm
GPM0578	5"	1.5mm	12,200	7/8"
GPM06UN	6"	1.9mm	10,100	7/8", 5/8", ◀
GPM07UN	7"	1.9mm	8,400	7/8", 5/8", ◀
GPM08UN	8"	1.9mm	7,400	7/8", 5/8", ◀
GPM0978	9"	2.2mm	6,600	7/8", 5/8"

Q-CUT

THE ULTIMATE WET BLADE FOR PORCELAIN PAVER TILE



- Formulated To Cut Hard Tiles Such As Quartzite/ Granite
- Tile Installer's Choice for Stone Tile
- Designed for Fast, Precision Chip-Free Cutting
- Perfect for 2cm Porcelain Paver Tile
- Wet Use Only (*Except for 4-1/2" and 5" Blades Can Be Used Wet or Dry*)



PART NO.	SIZE	THICKNESS	MAXIMUM RPM	ARBOR(S)
QZ4578	4-1/2"	1.6mm	13,200	7/8", 20mm
QZ0578	5"	1.6mm	12,200	7/8"
QZ0658	6"	1.4mm	10,100	7/8", 5/8", ⌀
QZ0758	7"	1.6mm	8,400	5/8"
QZ0858	8"	1.6mm	7,400	5/8"
QZ1058	10"	2.0mm	5,900	5/8"

PORCELLANA

ULTIMATE WET BLADE FOR PORCELAIN TILES



- 3/8" (10mm) Tall Diamond Layer for Long Life
- Tile Installer's Choice for Chip Free Wet Cutting
- Recommended for Granite, Marble, Porcelain, Engineered Stone, Travertine and Ceramic Tiles
- Best Wet Cutting Tile Blade on the Market
- Hybrid Wet Saw Blade for All Tiles
- Wet Use Only

PART NO.	SIZE	THICKNESS	MAXIMUM RPM	ARBOR(S)
PT04A+	4-3/8"	1.4mm	13,200	7/8", 20mm
PT05S	5"	1.4mm	12,200	7/8"
PT07A+	7"	1.6mm	8,400	5/8"
PT08A+	8"	1.6mm	7,400	5/8"
PT10A+	10"	1.6mm	5,900	5/8"

PORCELLANA for PRS

ULTIMATE WET BLADE FOR PORTABLE RAIL SAWS



- 3/8" (10mm) Tall Diamond Layer for Long Life
- Tile Installer's Choice for Chip-Free Wet Cutting
- Recommended for Granite, Marble, Porcelain, Engineered Stone, Travertine and Ceramic Tiles
- Best Wet Cutting Tile Blade for Rail Saw on the Market
- Hybrid Wet Saw Blade for All Tiles
- Wet Use Only



PART NO.	SIZE	THICKNESS	MAXIMUM RPM	ARBOR(S)
PT0801	8"	1.6mm	7,400	1", 7/8", 5/8"
PT1001	10"	1.6mm	5,900	1", 5/8"

VETRO

ULTIMATE WET BLADE FOR GLASS TILES



- Best Wet Cutting Glass Blade on the Market
- Designed for Chip-Free Cutting
- Tile Installer's Choice for Glass Tile
- Chip-Free Cutting on Most Demanding Applications
- Wet Use Only

PART NO.	SIZE	THICKNESS	MAXIMUM RPM	ARBOR(S)
WG0438	4-3/8"	1.0mm	13,200	7/8", 20mm
WG0700	7"	1.6mm	8,400	5/8"
WG0800	8"	1.6mm	7,400	5/8"
WG1000	10"	1.6mm	5,900	5/8"

VETRO for PRS

VETRO FOR PORTABLE RAIL SAW



- Wet Use Only
- Designed for Chip-Free Cutting
- Tile Installer's Choice for Glass Tile
- Best Wet Cutting Glass Blade for Rail Saw on the Market
- Chip-Free Cutting on Most Demanding Applications

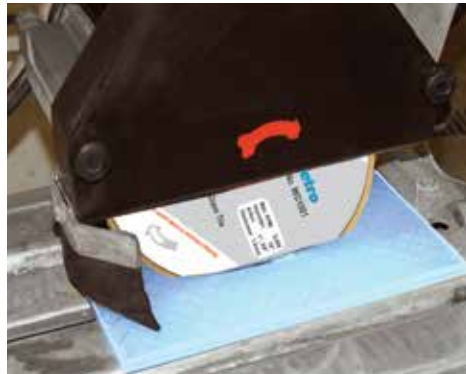

PART NO.	SIZE	THICKNESS	MAXIMUM RPM	ARBOR(S)
WG1001	10"	1.6mm	5,900	1", 5/8"

FLUSH CUTTING BLADE

VORTEX

INTRICATE & FLUSH CUTTING BLADE FOR GRANITE



- Requires Quad Drive to fit High-Speed Angle Grinder
- Perfect for Granite and Engineered Stone
- Specially Designed for Flush Cutting
- Stone Fabricator's Choice
- Chip-Free Cutting on Most Demanding Applications
- Side Protection Segments Help Cutting Straight



PART NO.	SIZE	THICKNESS	MAXIMUM RPM	ARBOR(S)	THREADS
FCD40AH	4"	2.5mm	14,500	20mm Quad Drive	
FCD50AH	5"	2.5mm	12,200	20mm Quad Drive	
AAH-20		Aluminum Adapter		20mm	5/8"-11
BAH-5/8		Brass Adapter		20mm	5/8"-11

VORTEX

INTRICATE & FLUSH CUTTING BLADE FOR MARBLE



- Requires Quad Drive to fit High-Speed Angle Grinder
- Specially Designed for Marble and Lime Stone
- Specially Designed for Flush Cutting
- Stone Fabricator's Choice
- Chip-Free Cutting on Most Demanding Application



PART NO.	SIZE	THICKNESS	MAXIMUM RPM	ARBOR(S)	THREADS
FCM50AH	5"	1.6mm	12,200	20mm Quad Drive	
AAH-20		Aluminum Adapter		20mm	5/8"-11
BAH-5/8		Brass Adapter		20mm	5/8"-11

ULTRACUT APR SERIES

HYBRID BLADE FOR INTRICATE & FLUSH CUTTING



- Unique Design for Flush Cutting Applications
- Removes Anchor Bolts, Concrete Re-Bar and Pipe From Floors and Walls
- Great for Building Contractors and Fabricators Who Work with Metal and Composite Materials
- Accepts Alpha® Exclusive Quad Drive Adapter for Mounting On Angle Grinders for “Flush Cutting”
- Available in 4-1/2”, 5” and 7”



PART NO.	SIZE	THICKNESS	MAXIMUM RPM	ARBOR(S)	THREADS
APR45QA	4-1/2"	1.7mm	13,200	20mm, Quad Drive	
APR05QA	5"	1.7mm	12,200	20mm, Quad Drive	
APR07QA	7"	1.9mm	8,400	20mm, Quad Drive	
BAH-5/8			Brass Adapter	20mm	5/8"-11
AAH-20			Aluminum Adapter	20mm	5/8"-11



CONTOUR

CURVE CUTTING BLADE FOR PORCELAIN/CRYST. GLASS

CONTOUR FOR PORCELAIN

Curve Cutting on Porcelain, Crystallized Glass and Sintered Slabs

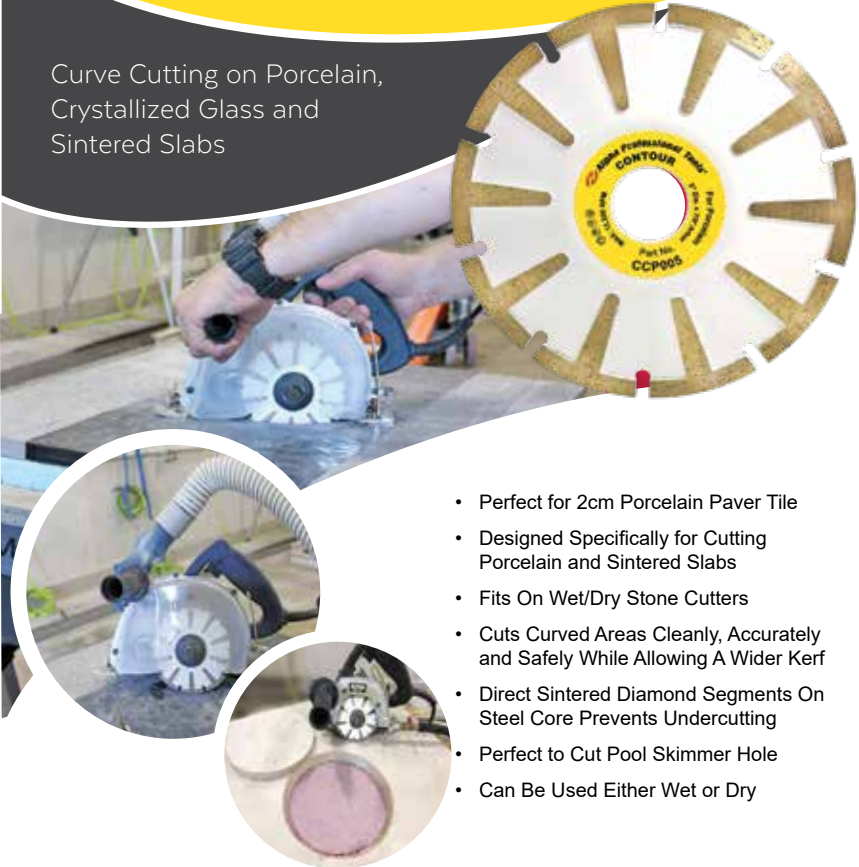

- Perfect for 2cm Porcelain Paver Tile
- Designed Specifically for Cutting Porcelain and Sintered Slabs
- Fits On Wet/Dry Stone Cutters
- Cuts Curved Areas Cleanly, Accurately and Safely While Allowing A Wider Kerf
- Direct Sintered Diamond Segments On Steel Core Prevents Undercutting
- Perfect to Cut Pool Skimmer Hole
- Can Be Used Either Wet or Dry

PART NO.	SIZE	THICKNESS	MAXIMUM RPM	ARBOR(S)	DEPTH OF CUT
CCP004	4"	4.0mm	14,500	7/8"	3/4"
CCP045	4-1/2"	4.0mm	13,200	7/8"	3/4"
CCP005	5"	4.0mm	12,200	7/8"	1-1/4"

CONTOUR

CURVE CUTTING BLADE FOR GRANITE AND ENG. STONE



- Specifically Developed for Cutting Granite Sinkholes
- Best Seller for Sinkhole Application
- Works Very Well On Engineered Stone, Quartzite and Harder Types of Natural Stone
- Cuts Curved Areas Cleanly, Accurately and Safely While Allowing A Wider Kerf
- Fits on Wet/Dry Stone Cutters
- Direct Sintered Diamond Segments On Steel Core Prevents Undercutting
- Fits On CNC Router with Cutting Head
- Can Be Used Either Wet or Dry

PART NO.	SIZE	THICKNESS	MAXIMUM RPM	ARBOR(S)	DEPTH OF CUT
CCB004	4"	4.0mm	14,500	7/8"	3/4"
CCB045	4-1/2"	4.0mm	13,200	7/8"	3/4"
CCB005	5"	4.0mm	12,200	7/8"	1-1/4"
CCB006	6"	4.0mm	10,100	7/8"	1-5/8"

CONTOUR

CURVE CUTTING FOR MARBLE



- Design Specifically Developed for Cutting Marble and Limestone Sinkholes
- Fits On Wet/Dry Stone Cutters
- Cuts Curved Areas Cleanly, Accurately and Safely While Allowing A Wider Kerf
- Electroplated Diamonds on Both Sides of the Steel Core
- Can Be Used Either Wet or Dry

PART NO.	SIZE	THICKNESS	MAXIMUM RPM	ARBOR(S)	DEPTH OF CUT
CCM005	5"	1.4mm	12,200	7/8"	1-1/4"

HOT-ROD

CHANNEL CUTTING BLADE FOR STAIR TREADS



- Perfect for Channel Cutting with Wet/Dry Stone Cutters
- Great for Grout Removal with Ecocutter
- Perfect to Cut Anti-Slip Grooves and Water Drip
- Reliable Proven Performer
- Can Be Used Wet or Dry

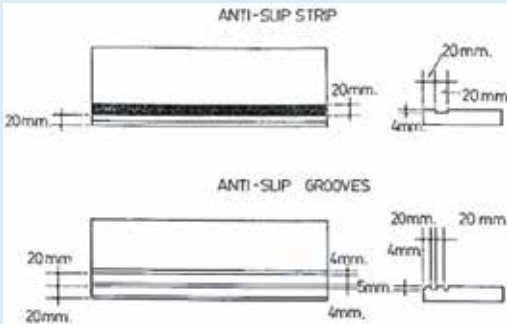

ROD SIZE

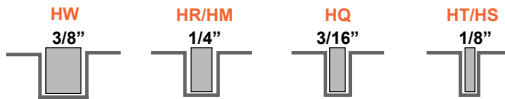

GROUT WIDTH



*Marble

PART NO.	SIZE	THICKNESS	MAXIMUM RPM	ARBOR(S)	RECOMMENDED FOR
HT03A+	3"	4.2mm	14,500	7/8", 20mm	1/8" Rod
HQ03A+	3"	5.5mm	14,500	7/8", 20mm	3/16" Rod
HR03A+	3"	7.0mm	14,500	7/8", 20mm	1/4" Rod
HW03A+	3"	11.5mm	14,500	7/8"	3/8" Threaded Rod
HS03A+*	3"	4.75mm	14,500	7/8", 20mm	1/8" Rod
HM03A+*	3"	6.5mm	14,500	7/8", 20mm	1/4" Rod
HT04A+	4"	4.2mm	14,500	7/8", 20mm	1/8" Rod
HR04A+	4"	7.0mm	14,500	7/8", 20mm	1/4" Rod

PT CUTTER

ULTIMATE DRY BLADE FOR PORCELAIN PAVER TILE



- Best Dry Cutting Turbo Blade on the Market
- Perfect for Porcelain Paver Tile
- 6mm Tall Diamond Layer for a Long Life
- Recommended for Landscaping Tiles
- Fits Most Gas-Powered Demolition Saws
- Can Be Used Wet or Dry
- Special Turbo Rim Diamond Layer Sintered Directly to the Steel Core
- Can Be Used On Portable Rail Saws



PART NO.	SIZE	THICKNESS	MAXIMUM RPM	ARBOR(S)
LT09A+	9"	2.5mm	6,600	7/8", 5/8"
LT12A+	12"	2.6mm	6,200	1", 7/8", 20mm
LT14A+	14"	2.8mm	5,360	1", 7/8", 20mm

BLADEMASTER

HIGH-SPEED DIAMOND BLADE FOR PORCELAIN PAVER TILE



- High-Quality Laser-Welded Segmented Blades for High-Speed Demolition Saws
- Slices Through Materials with Ease
- Segment Height at 1/2" Ensure a Long Life
- Fits Masonry Saws & Road Cutters
- Can Be Used Wet or Dry
- Available in 12", 14" and 16" Diameters with Pin Hole

PART NO.	SIZE	THICKNESS	MAXIMUM RPM	ARBOR(S)
BML1214	12"	2.9mm	6,200	1" w/pin hole
BML1414	14"	3.0mm	5,360	1" w/pin hole
BML1614	16"	3.1mm	4,700	1" w/pin hole

RESCUE

DEMOLITION BLADE CUTS IT ALL



- Slices Through Most Materials with Ease
- Works on Concrete, Paver, Stone, PVC Pipe, Ductile Iron, Granite, Tavertine, Blue Stone, Brick Block, Wood, Glass and Rubberized Materials
- Proven Winner for Firefighters, Police Officers and Construction Professionals
- Use on Gas-Powered Cut-Off Saw
- Available in 9", 12" and 14" Diameters

PART NO.	SIZE	THICKNESS	MAXIMUM RPM	ARBOR(S)
RB09A+	9"	2.8mm	8,300	7/8"
RB12A+	12"	3.0mm	6,200	1", 7/8", 20mm w/Pin Hole
RB14A+	14"	3.2mm	5,360	1", 7/8", 20mm w/Pin Hole
DR14A+	14"	3.4mm	5,360	1", 7/8", 20mm



QUAD ADAPTERS



- Designed for Flush Cutting Blades with Four Mounting Holes
- Made Of Durable High-Quality Brass or Aluminum
- Easily Mounted To Any Quad Drive Blade
- Available in Various Thread Sizes

PART NO.	TYPE	ARBOR(S)	THREADS
AAH-7/8	Aluminum	7/8"	5/8"-11
AAH-20	Aluminum	20mm	5/8"-11
BAH-5/8	Brass	20mm	5/8"-11
BAH-M10Q	Brass	20mm	M10 - 1.25
BAH-M14	Brass	20mm	M14-2

FLANGE ADAPTERS



- Designed for Blades That Are Eight Inches or Larger with Eight Mounting Holes
- Made Of Durable High-Quality Steel
- Easily Mounted To Any Large Flush Cutting Blade
- Available in 5/8"-11 and M14-2 Thread Sizes

PART NO.	TYPE	THREADS
FAH-5/8	Adapter	5/8"-11
FAH-M14	Adapter	M14-2

SPIKE RULER



- Designed As A Precision Ruler That Will Not Move On Thin Porcelain Tiles or Panels with Texturized Surfaces
- Secures Ruler To The Material
- Convenient and Easy To Use
- Made Of Aluminum with A Wood Base

PART NO.	SIZE
SPR100	3'4" (1m)

DRESSING STICK



- Designed To Expose New Cutting Surfaces or Re-Open Glazed Diamond Blades and Grinding Wheels
- Removes Sinter Bond From Cutting Edge
- Can Be Used To Ease Sharp Corners
- Bond Type: Silicon Carbide

PART NO.	SIZE	GRIT
290006	8" x 1.5" x 1.5"	60

PROFILING

Perfect round over edges

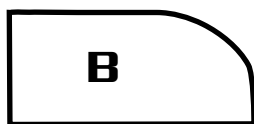

Demi-Bullnose

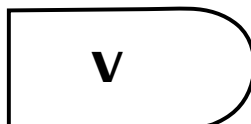

Full Bullnose

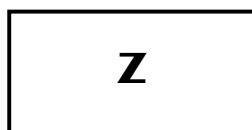

Straight Edge

PROFILER B-SERIES

CREATES PERFECT DEMI-BULLNOSE EDGE



- Perfect for 2cm Porcelain Paver Tile
- Use On Travertine, Granite, Engineered Stone, Marble, Concrete, Crystallized Glass and Porcelain Slabs
- Create A Perfect Demi-Bullnose/Roundover Edge Treatment
- Nylon Guide and Rotary Touchier Assures The Proper Depth Of Cut Is Achieved
- Equipped with A 5/8"-11 Female Thread and Internal Water Passage Holes
- Fits On All Popular Water-Fed Polishers

PART NO.	SIZE	MAXIMUM RPM	THREADS	SHAPE
PFB051	3/16" (0.5cm)	3,500	5/8"-11	Demi-Bullnose
PFB101	3/8" (1.0cm)	3,500	5/8"-11	Demi-Bullnose
PFB131	1/2" (1.3cm)	3,500	5/8"-11	Demi-Bullnose
PFB201	3/4" (2.0cm)	3,500	5/8"-11	Demi-Bullnose
PFBNG01	Fits up to 4cm Profilers		Nylon Guide	
PFBNG02	Fits All Sizes of Profilers		Nylon Guide	

PROFILER Z-SERIES

PERFECT 90-DEGREE EDGE GRINDING



- Perfect for 2cm Porcelain Paver Tile
- Vertical Grinding On All Types Of Materials
- Never Loses Shape for True Zero Tolerance
- Nylon Guide and Rotary Touchier Assures Uniformity
- Equipped with A 5/8"-11 Female Thread and Internal Water Passage Holes
- Fits On All Popular Water-Fed Polishers

PART NO.	SIZE	MAXIMUM RPM	THREADS
PFZ301	1-1/4" (3cm)	3,500	5/8"-11
PFZ401	1-1/2" (4cm)	3,500	5/8"-11
PFBNG01	Fits up to 4cm Profilers		Nylon Guide
PFBNG02	Fits All Sizes of Profilers		Nylon Guide

PROFILER V-SERIES

CREATES PERFECT BULLNOSE EDGE



- Perfect for 2cm Porcelain Paver Tile, Pool Coping, Steps and Caps
- Create A Perfect Bullnose/Roundover Edge Treatment
- Use On Travertine, Granite, Engineered Stone, Marble, Limestone, Concrete, Crystallized Glass and Porcelain Slabs
- Eliminate The Time-Consuming Calibration Process for Seamed Pieces
- Nylon Guide and Rotary Touchier Assures The Edges Are Uniform
- Equipped with A 5/8"-11 Female Thread and Internal Water Passage Holes
- Fits On All Popular Water-Fed Polishers

PART NO.	SIZE	MAXIMUM RPM	THREADS
PFV201	3/4" (2cm)	3,500	5/8"-11
PFV301	1-1/4" (3cm)	3,500	5/8"-11
PFV401	1-1/2" (4cm)	3,500	5/8"-11
PFV501	2" (5cm)	5,000	5/8"-11
PFV601	2-3/8" (6cm)	5,000	5/8"-11
PFBNG01	Fits up to 4cm Profilers		Nylon Guide
PFBNG02	Fits all Profilers		Nylon Guide



PROFILER B



PROFILER V



PROFILER Z

DRILLING

Versatile and can be adapted for use in construction trades wherever holes are needed.



WET CORE BITS

ULTIMATE WET CORE DRILLING BIT



- Perfect for Porcelain Paver Tile
- Designed for Drilling The Faucet-Mounting Holes in Countertops and Vanities
- Very Fast Cutting On Granite and Engineered Stone
- Make Clean Rounded Corners for Square or Rectangular Sinkholes
- Versatile and Adaptable in Many Industries for Water, Gas and Electrical Piping
- Fits On Most Popular Water-Fed Polishers

PART NO.	DIAMETER	MAXIMUM RPM	THREADS
DCB00380	3/8"	3,500	5/8"-11
DCB00500	1/2"	3,500	5/8"-11
DCB00750	3/4"	3,500	5/8"-11
DCB01000	1"	3,500	5/8"-11
DCB01250	1-1/4"	3,500	5/8"-11
DCB01375	1-3/8"	3,500	5/8"-11
DCB01500	1-1/2"	3,500	5/8"-11
DCB02000	2"	3,500	5/8"-11
DCB02500	2-1/2"	3,500	5/8"-11

DRY CORE BITS

HIGH-SPEED DRY CORE BIT FOR GRANITE/ENG. STONE



- Perfect for Porcelain Paver Tile
- Designed for Jobsite Drilling Of Faucet-Mounting Holes in Countertops and Vanities
- Very Fast Cutting On Granite and Engineered Stone
- Convenient Dry Application
- Make Clean Rounded Corners for Square or Rectangular Sinkholes
- Versatile and Adaptable in Many Industries for Water, Gas and Electrical Piping
- Fits On Most Popular High-Speed Grinders

PART NO.	DIAMETER	MAXIMUM RPM	THREADS
DRB00500	1/2"	12,000	5/8"-11
DRB00750	3/4"	12,000	5/8"-11
DRB01000	1"	12,000	5/8"-11
DRB01250	1-1/4"	12,000	5/8"-11
DRB01375	1-3/8"	12,000	5/8"-11
DRB01500	1-1/2"	12,000	5/8"-11
DRB02000	2"	12,000	5/8"-11

VACUUM BRAZED TRIMMER BIT

DRY CUTTING OF LARGE HOLES OR CURVED LINES



- Great For Use In Construction Trades Wherever Non-Standard Shaped Cutouts As Needed
- Perfect For Electrical Receptacles, Water-Valve Holes, Drains, Shower Knobs, Etc.
- Vacuum Brazed Technology Provides Extended Life
- Use On Granites, Engineered And Natural Stones, Porcelain And Ceramic Tiles
- Can Be Used Wet Or Dry
- Fits On A High-Speed Trimmer Tools

PART NO.	DIAMETER	MAXIMUM RPM
DTB00250	1/4"	33,000

ELECTROPLATED DRILL BITS

PREMIUM DRILL BITS FOR ANCHOR/PIPE HOLES



- Designed for Drilling Holes in Tile and Stone for Pre-Installation or Post-Installation Placement
- Works Great On Marble, Granite, Engineered Stone, Ceramic, Porcelain and Glass Tile and Panels
- Can Be Used On A Standard 3/8" or Larger Drill
- Can Fit On Water-Fed Polishers with 5/8"-11 Spindles Using The Drill Bit Adapter
- Ideal for Drilling Holes for Anchors for Bathroom Fixtures, Faucet and Plumbing Pipes
- Available in 3/16", 1/4", 5/16", 3/8", 1/2", 1-3/8" and 1-1/2" Sizes
- Wet Use Only

PART NO.	DIAMETER	MAXIMUM RPM	TYPE
CH7205	3/16"	3,500	3/8" Shank
CH7206	1/4"	3,500	3/8" Shank
CH7208	5/16"	3,500	3/8" Shank
CH7210	3/8"	3,500	3/8" Shank
CH7212	1/2"	3,500	3/8" Shank
CH7235	1-3/8"	3,500	3/8" Shank
CH7240	1-1/2"	3,500	3/8" Shank
CH1058			Adapter 10mm to 5/8**

*(for all polishers)

DRILL BIT GUIDE

WATER DELIVERY SYSTEM



- Prevents Wandering Drill Bits
- Delivers Sufficient Water While Providing A Secure Drilling Position
- Fits Up To 1-3/8" Diameter
- Use It with Electroplated Drill Bits
- Ideal When Drilling 1/4" Anchor Holes When Installing Towel Bars, Soap Dishes, Shelves, Cabinets and Shower Door Frames
- Suction Cup Creates A Vacuum That Secures The Guide During Application

HOW TO USE:



Soak the foam rubber on the back side with water.



Press the body to the tile and make sure it adheres properly.



Pour water up to the mark On the tank.



Slide the switch to the open position. Make sure the water drips.



Place tip of drill bit into the guide Position. Then start drilling.



Slide switch to the closed position. Pull the rubber to remove the water-feed system.



NOTE: working with mosaic tile or near grout lines use tape to secure.*

PART NO.	DESCRIPTION
WDS138	Drill Bit Guide/Water Delivery System

POLISHING

Full range of Superior Wet and Dry Diamond polishing pads

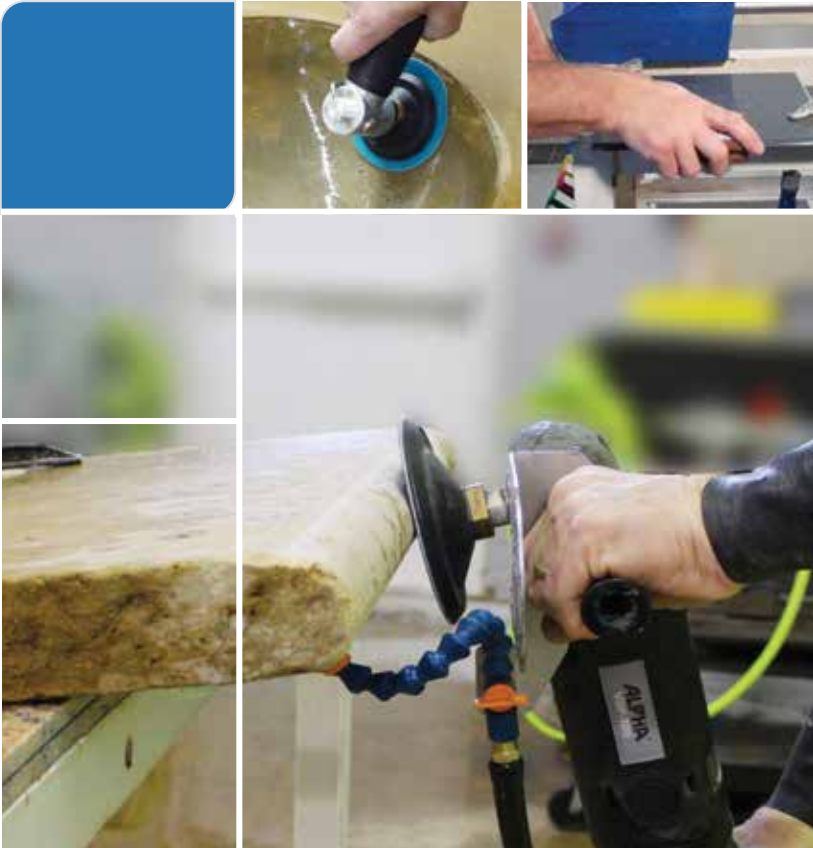

HAND PADS

HAND POLISHING PADS

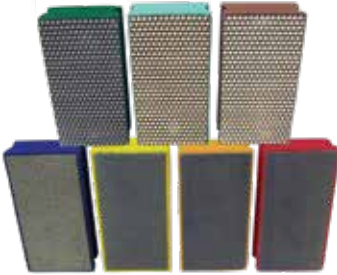

- Convenient, On-Site Polishing
- Use On Travertine, Porcelain Paver Tile, Glass, Ceramics, Marble, Granite, Concrete, Terrazzo and Quartz Surfaces
- Two Bond Types To Provide The Best Possible Finish
- Available in Electroplated and Resin Grits



ELECTROPLATED GRITS:

This type of pad uses nickel plating technology to hold each individual diamond in place and is available in 60, 150, 300 and 500 grits.

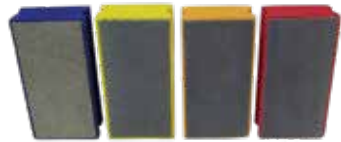

RESIN GRITS:

This type has a finer diamond grit than electroplated pads. The resin bond is coated on a special backing material and is available in 1000, 2000 and 3000 grits best suited for honing to polishing.

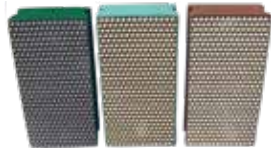

PART NO.	GRIT	COLOR	BOND TYPE
DHP0060	60	Blue	Electroplated
DHP0150	150	Yellow	Electroplated
DHP0300	300	Orange	Electroplated
DHP0500	500	Red	Electroplated
DHP1000	1000	Dark Green	Resin
DHP2000	2000	Light Green	Resin
DHP3000	3000	Brown	Resin
DHPKIT			Set of 7

CERAMICA EX

WET POLISHING FOR ALL STONES



- Produces A High-Quality Shine
- Polishes On Porcelain, Granite, Travertine, Limestone, Concrete, etc.
- Ideal for Polishing Inside Corners and A Tight Radius
- Works Very Well On Tough Materials Including Tough To Polish Black and Green Marbles
- Extremely Flexible

HOOK AND LOOP		3"	4"	5"
GRIT	COLOR	PART NO.	PART NO	PART NO.
200	Yellow	EX30200R	EX40200R	EX50200R
500	Red	EX30500R	EX40500R	EX50500R
1000	Dark Green	EX31000R	EX41000R	EX51000R
2000	Light Green	EX32000R	EX42000R	EX52000R
3000	Brown	EX33000R	EX43000R	EX53000R
ALL	Assortment (1 each)		EX40KIT	

SANDPAPER

CONCRETE AND MARBLE POLISHING



- Waterproof Hook and Loop Backed Silicon Carbide Abrasive
- Use On Marbles and Softer Types of Natural Stone
- Can Also Be Used To Polish Glass, Metal and Wood
- Very Adaptable To Onsite Work and Easy To Use
- Resists Clogging When Used Wet
- Can Be Used Wet or Dry

HOOK AND LOOP		4"	5"
GRIT	QUANTITY	PART NO.	PART NO.
80	50	MP40080	MP50080
120	50	MP40120	MP50120
240	50	MP40240	MP50240
320	50	MP40320	MP50320
400	50	MP40400	MP50400
500	50	MP40500	MP50500
600	50	MP40600	MP50600
Assortment	50	MP40KIT	MP50KIT

ANTIQUE BRUSH WHEELS

BRUSH WHEELS FOR TEXTURED FINISHES



- Create A Textured Finish On The Edge and Surface Of Engineered Stone/Quartz Surfaces
- Developed with TYNEX®, A Filament From Dupont, To Ensure Safety and Exceptional Performance
- Utilizes A Snail Lock Adapter (SFAT)
- Fits Most Popular Edge Polishing Machines, Hand-Held Sanders and Polishers
- Grits Sequence of #24, #36, #60, #120, #240 and #320
- Can Be Used On Other Stone Such As Granite



SNAIL LOCK			4"	5"
GRIT	BOND TYPE	MAXIMUM RPM	PART NO.	PART NO.
24	Resin	4,000	AB4024	AB5024
36	Resin	4,000	AB4036	AB5036
60	Resin	4,000	AB4060	AB5060
120	Resin	4,000	AB4120	AB5120
240	Resin	4,000	AB4240	AB5240
320	Resin	4,000	AB4320	AB5320
Snail Lock Adapter		4,000	PVA-5/8	
Snail Lock Adapter		2,000		SFAT-5/8

ACCESSORIES

Exclusively from Alpha® for the most popular tools



ECOGUARD C

HYBRID DUST COLLECTION COVER FOR CUTTING



- Designed for Collecting Dust When Using A High-Speed Angle Grinder
- Accepts Up To 5" Diameter Blades
- Can Be Used with or Without A Vacuum
- Rugged Construction for Heavy-Duty Applications
- Removes More Than 90% Of Dust
- Fits On Selected 4-1/2" - 5" High-Speed Angle Grinders
- Straight Precise Cuts Using Foot Plate
- Adjustable Cutting Depth

PART NO.	SIZE	DESCRIPTION
ECOGRDCT	5"	Dust Collection Cover C
201549		Dust Bag
500026	18"	Flexible Connector Hose (1-1/2" Tapered-2-1/4")
500073	54"	Flexible Connector Hose (1-1/2" Tapered-2-1/4")

ECOGUARD D

DUST AND DEBRIS GUARDS FOR DRILLS / HAMMER DRILLS



- Collects Dust & Debris with Ease While Using Drills/ Hammer Drills
- Convenient and Easy to Use
- Eliminates Clean-Up and Downtime on the Jobsite
- Fits Most Popular Drills and Hammer Drills
- Made for: Makita® BHR202Z, Bosch RHH180, DeWalt DCH253, Milwaukee 2605-20, Hilti TE4-A18



Optional Universal Handle



Optional Vacuum Adapter Kit



Optional Exhaust Hose

PART NO.	SIZE	RECOMMENDED FOR	DESCRIPTION
ECOGRDDL	≥ 6"	Long Drill Bits	Dust Collection Cover DL
ECOGRDDS	≤ 6"	Short Drill Bits	Dust Collection Cover DS
803172		Ecoguard D	Universal Handle for Hammer Drills
ECOVAKIT		Use With Ecoguard D	Vacuum Adapter Kit
VH91100	12ft /3.6m	3/4" Hose Diameter	Exhaust Hose 1-1/4" O.D. threaded x 2-1/4" standard

ECOGUARD CD

DUST AND WATER GUARD FOR CORE DRILLING



- Wet/Dry Cover for Drilling and Core Drilling Applications
- Fits Most Vacuum Dust Hoses
- Accepts up to 2-1/2" Core Bit
- Can Be Secured On Horizontal and Vertical Surfaces with Vacuum During Application
- Prevents Splashing When Used with Water

PART NO.	RECOMMENDED FOR	DESCRIPTION
ECOGRDCD	Core Drilling	Dust Collection Cover CD

ECOGUARD G5 / G7

DUST COLLECTION COVER FOR GRINDING



- Designed for Collecting Dust When Using A High-Speed Angle Grinder
- Accepts Grinding Wheels Up To: 5" (G5), 7" (G7)
- Rugged Construction for Heavy-Duty Applications
- Perfect for Grinding and Sanding or Surface Preparation Work
- Can Grind Tight Against The Wall
- Clear Cover for Better Visibility
- Fits On Most High-Speed Angle Grinders: 4-1/2"- 5" (G5), 7" & 9" (G7)
- Easy Installation and Wheel Changes
- The G7 Has A Flexible Head Allowing for A Natural Grinding Motion
- Removes More Than 90% of the Dust
- Must Be Used with A Vacuum

PART NO.	SIZE	DESCRIPTION
ECOGRDGR	5"	Dust Collection Cover G5
ECOGRDG7	7"	Dust Collection Cover G7
500026	18"	Flexible Connector Hose (1-1/2" Tapered-2-1/4")
500073	54"	Flexible Connector Hose (1-1/2" Tapered-2-1/4")
ECOG5KIT	5"	Ecoguard G5 & 18" Connector Hose Kit
ECOG7KIT	7"	Ecoguard G7 & 54" Connector Hose Kit

ECOGUARD G7



PART#: ECOGRDG7

DUST-FREE GUARDS

ECOGUARD W5 / W6 / W9

DUST COLLECTION COVER FOR WIDER KERF CUTTING



PART#: **ECOGRDW6**



PART#: **ECOGRDW5**

- Designed for Collecting Dust and Debris When Using A High-Speed Angle Grinder
- Perfect for Tuckpointing and Crack Chasing
- Accepts 5" Diameter Blades (W5), 6" Diameter Blades (W6), 7" and 9" Diameter Blades (W9)
- Removes More Than 90% Of Dust
- Rugged Construction for Heavy-Duty Applications
- Straight Precise Cuts Using Support Base
- Easy Installation and Blade Changes
- Fits On Selected 4-1/2", 5", 6", 7" and 9" High-Speed Angle Grinders
- Adjustable Cutting Depth - Maximum 1-1/2" (W5), 1-3/4" (W6) and 2-3/8" (W9)
- Must Be Used with A Vacuum



PART#: **ECOGRDW9**



**Industrial
Dust
Collection
Cover**

PART NO.	SIZE	DESCRIPTION
ECOGRDW5	5"	Dust Collection Cover W5
ECOGRDW6	6"	Dust Collection Cover W6
ECOGRDW9	9"	Dust Collection Cover W9
500026	18"	Flexible Connector Hose (1-1/2" Tapered-2-1/4")
500073	54"	Flexible Connector Hose (1-1/2" Tapered-2-1/4")
ECOW5KIT	5"	Ecoguard W5 & 18" Connector Hose Kit
ECOW6KIT	6"	Ecoguard W6 & 18" Connector Hose Kit
ECOW9KIT	9"	Ecoguard W9 & 54" Connector Hose Kit

RIGID BACKER PADS

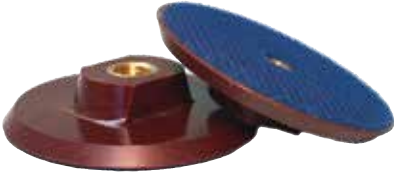

- High-Quality Backer Pad Is Super Rigid and Flat
- Eliminates The Wavy Finish When Polishing
- Hook and Loop Backed
- The Rigidity Of The Pad Enables Work in Small Areas Such As Corners or Staircases
- Accepts Polishing Pads, Sandpaper and Felt Wheels

PART NO.	SIZE	MAX RPM	THREADS
GP35/8RG	3"	6,000	5/8"-11
GP45/8RG	4"	6,000	5/8"-11
GP55/8RG	5"	6,000	5/8"-11
RGSPACER			Spacer

FLEXIBLE BACKER PADS



- High-Quality Backer Pad Is Extremely Flexible
- Ideal for Tough Contours and Inside Curves
- Hook and Loop Backed
- Highly Resistant To The Rigors Of Daily Use Provides A Long Life
- Accepts Polishing Pads, Sandpaper and Felt Wheels

PART NO.	SIZE	MAX RPM	THREADS
GP25/8PD	2"	6,000	5/8"-11
GP35/8PD	3"	6,000	5/8"-11
GP45/8PD	4"	6,000	5/8"-11
GP55/8PD	5"	6,000	5/8"-11

GV BACKER PADS



- High-Quality Backer Pad Is Rigid and Flat, But Provides Just The Right Amount Of Flexibility
- Ideal for Bullnosed Edges and Flat Surfaces.
- Hook and Loop Backed
- Accepts Polishing Pads, Sandpaper and Felt Wheels
- Fits On Makita® GV5000 & GV5010 Sanders

PART NO.	SIZE	MAXIMUM RPM	DESCRIPTION
GV4MPPD	4"	4,500	M8-1.25 Male
GV5MPPD	5"	4,500	M8-1.25 Male

ACCESSORIES

GROUND FAULT CIRCUIT INTERRUPTER



- Protect Polishing Personnel From Lethal Ground Current Loads
- Highly Recommended Piece Of Equipment
- Rated for 15 Amps

PART NO.	DESCRIPTION
GFCI-1	Ground Fault Circuit Interrupter

SAFETY GLASSES



- Designed for Safety and Comfort
- A Lightweight Frame with Padded Temples
- Adjustable Side Arms
- Soft Rubber Nose Bridge
- Clear Anti-Scratch Lenses
- Available in a single pair or 12-pack
- Complies with standard # BS EN 166:2001



PART NO.	DESCRIPTION
173002	Safety Glasses (Box of 12)
173008	Safety Glasses (Single Pair)

RUST INHIBITOR OIL



- Protects Your System From Rust
- Keeps Pneumatic Tools Lubricated

PART NO.	RECOMMENDED FOR	DESCRIPTION
AIR-008	Pneumatic Tools	Rust Inhibitor Oil 8oz (237ml)

Filter/Regulator

MANIFOLD SYSTEM

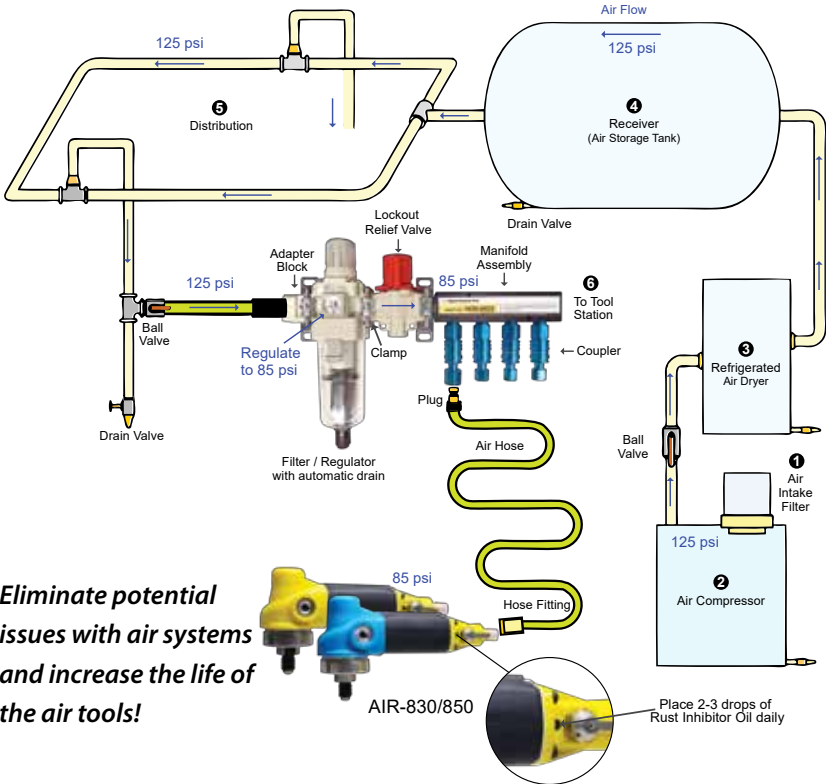

Eliminate potential issues with air systems and increase the life of the air tools!

Can be easily **CUSTOMIZED** to your shop requirements!

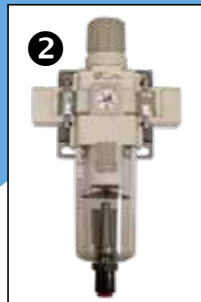
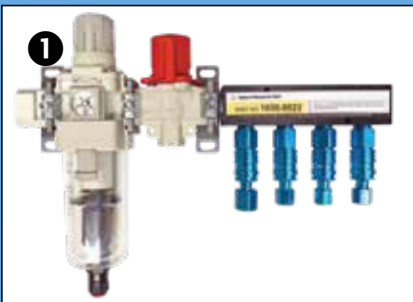

1 Complete System for Multiple Tools

PART NO.	CFM	DESCRIPTION	ADAPTER BLOCK	PORT	PLUGS INCLUDED
1030-0021	53	3/8" Filter/Regulator Manifold	3/8" NPT	3 Couplers	(3) 1/4" Female NPT
1030-0022	53	3/8" Filter/Regulator Manifold	1/2" NPT	3 Couplers	(3) 1/4" Female NPT
1030-0023	106	1/2" Filter/Regulator Manifold	1/2" NPT	4 Couplers	(3) 1/4" Female NPT + (1) 3/8" Female NPT
1030-0024	106	1/2" Filter/Regulator Manifold	3/4" NPT	4 Couplers	(3) 1/4" Female NPT + (1) 3/8" Female NPT

2 Filter Regulator Kits for a Single Tool

PART NO.	SIZE	TYPE	DESCRIPTION
1030-0070	53 CFM	3/8" Filter/Regulator Kit	Filter/Regulator, Adapter Blocks & T-Clamps
1030-0071	53 CFM	3/8" Filter/Regulator Kit	Filter/Regulator, Adapter Blocks & T-Clamps
1030-0072	53 CFM	3/8" Filter/Regulator Kit	Filter/Regulator, Adapter Blocks & T-Clamps
1030-0073	106 CFM	1/2" Filter/Regulator Kit	Filter/Regulator, Adapter Blocks & T-Clamps
1030-0074	106 CFM	1/2" Filter/Regulator Kit	Filter/Regulator, Adapter Blocks & T-Clamps
1030-0075	106 CFM	1/2" Filter/Regulator Kit	Filter/Regulator, Adapter Blocks & T-Clamps

HOSES

- All-Weather Flexibility From -40°F to +200°F
- Kink-Free Under Pressure
- Lightweight and Abrasion Resistant
- Zero Memory Allowing It To Lay Flat
- Made Of A Premium Hybrid Polymer Material
- Comes in Many Lengths
- Pneumatic and Water Hoses Available
- Many Connectors Available



AIR HOSE

(FOR AIR-680/830/850/PSC-600/PSG-658)

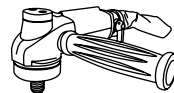

PART NO.	SIZE	DIAMETER	THREADS
1030-0002	15ft./4.5m	1/4"	1/4" NPSM x 1/4" NPT(Female Swivel)
1030-0010	20ft./6.0m	1/4"	1/4" NPSM x 1/4" NPT(Female Swivel)

Available Hose sizes: 25ft, 30ft, 35ft & 40ft. Call for Custom sizes or for more information.



WATER HOSE

(FOR AIR-680/830/850/PSC-600/PSG-658)

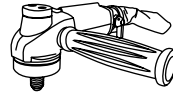

PART NO.	SIZE	DIAMETER	THREADS
1030-0003	15ft./4.5m	1/4"	1/8" NPSM x 3/4" 11GHT(GHT)
1030-0011	20ft./6.0m	1/4"	1/8" NPSM x 3/4" 11GHT(GHT)

Available Hose sizes: 25ft, 30ft, 35ft & 40ft. Call for Custom sizes or for more information.



ADAPTER HOSE

(FOR MANIFOLD SYSTEMS)

PART NO.	SIZE	DIAMETER	THREADS
1030-0025	1ft./0.3m	1/2"	1/2" NPT Swivel
1030-0026	2ft./0.6m	1/2"	1/2" NPT Swivel
1030-0027	3ft./0.9m	1/2"	1/2" NPT Swivel



MOBILE HOSE

(FOR MANIFOLD SYSTEMS)

PART NO.	SIZE	DIAMETER	THREADS
1030-0050	15ft./4.5m	1/2"	1/2" NPT Swivel w/Hose Protector
1030-0052	20ft./6.0m	1/2"	1/2" NPT Swivel w/Hose Protector

Available Hose sizes: 25ft, 30ft, 35ft & 40ft....Custom sizes also available. Call for more information.



EXHAUST HOSE

(SPECIALTY)

- Use with ECOVAKIT

PART NO.	SIZE	DIAMETER	THREADS
VH91100	12ft./3.6m	3/4"	1-1/4" O.D. threaded x 2-1/4" standard

WET BLADE CUTTING KIT

CONVERT A HIGH-SPEED ANGLE GRINDER INTO A WET TOOL



WBC9KIT



- Can Be Used On Most Grinders With Minimal Alterations
- Fits Most 7" and 9" Angle Grinders
- Includes Kink-Free, Water-Feed Supplies, Plus GFCI



Kit includes: 9" Safety Guard, Loc-Line Assembly, Plastic Tie, 4 Plastic Collars, Adapter (1/4 NPT>>>M10*P.1.O), Water Hose Assembly, Memory Wrap (3ft. / 1M), Quick Connect Adapter, GFCI Plug (120V), Hook & Loop Tie & Screw w/Spring Lock Washer

PART NO.	SIZE	TYPE	RECOMMENDED FOR	DESCRIPTION
WBC9KIT	9"	110V	7" & 9" High-Speed Angle Grinders	Wet Blade Cutting Kit
WBC9KIT2V	9"	220V	7" & 9" High-Speed Angle Grinders	Wet Blade Cutting Kit

WET BLADE CUTTING KITS

CONVERT DRY GRINDER FOR WET CUTTING



- Designed To Convert A High-Speed Angle Grinder Into A Wet Tool
- Can Be Used On Most Grinders with Minimal Alterations
- Fits Most 4-1/2", 5" and 6" High-Speed Angle Grinders
- Kink-Free Water Hose for Easy Maneuverability and Reducing Operator Fatigue
- Save Money and Use Your Tool Wet or Dry!

Kit includes: Safety Guard, Loc-Line Assembly, Plastic Tie, Stainless Steel Collar, Plastic Collar, Adapter (1/4 NPT>>>M10*P.1.O), Water Hose Assembly, Memory Wrap (3ft. / 1M), Quick Connect Adapter, GFCI Plug (120V) & Hook & Loop Tie

PART NO.	SIZE	TYPE	RECOMMENDED FOR	DESCRIPTION
WBC5KIT	5"	110V	4-1/2", 5" & 6" High-Speed Angle Grinders	Wet Blade Cutting Kit
WBC6KIT	6"	110V	4-1/2", 5" & 6" High-Speed Angle Grinders	Wet Blade Cutting Kit
WBC5KIT2V	5"	220V	4-1/2", 5" & 6" High-Speed Angle Grinders	Wet Blade Cutting Kit
WBC6KIT2V	6"	220V	4-1/2", 5" & 6" High-Speed Angle Grinders	Wet Blade Cutting Kit

WET SANDING/ POLISHING KIT

CONVERTS DRY POLISHER / SANDER INTO A WET TOOL



- Designed To Convert A Dry Polisher Into A Wet Tool
- Save Money and Use Your Tool Wet or Dry!
- Quick Solution for OSHA Compliance
- Kit includes: Safety Guard, Loc-Line Assembly, Water Hose Assembly, Memory Wrap (3ft. / 1M), Quick Connect Adapter, GFCI Plug (120V) & Hook & Loop Strap

Kit includes: Safety Guard, Loc-Line Assembly, Water Hose Assembly, Memory Wrap (3ft. / 1M), Quick Connect Adapter, GFCI Plug (120V) & Hook & Loop Strap

PART NO.	RECOMMENDED FOR	DESCRIPTION
WSPKIT	Sanders & Polishers	Wet Sanding & Polishing Kit

POOL COPING KIT

PROFILING

SANDING



KIT INCLUDES

VDP-700 VARIABLE SPEED ROTARY POLISHER

Professional Grade Industrial Polisher
Part #: **VDP-700**

WET SANDING/POLISHING KIT

Designed to convert a Variable Grinder, Sander or Polisher into a Wet Sanding/Polishing Tool
Part #: **WSPKIT**

PROFILER V

Creates A Perfect Bullnose/ Roundover Edge Treatment
Part #: **PFV501**

FLEXIBLE BACKER PAD 5"

High-Quality Backer Pad Is Extremely Flexible
Part #: **GP55/8PD**

SANDPAPER #80 GRIT

Multi-Purpose Sanding of Marble & Softer Types of Natural Stone
Part #: **MP50080**

MULTI-PURPOSE WATERPROOF APRON SLEEVELESS

Part #: **APRON2000**



KIT Part # 5480-6100

PART NO.	RECOMMENDED FOR	DESCRIPTION
5480-6100	Pool Coping	Pool Coping Kit



Multi-Purpose Waterproof Apron - LONG SLEEVE



Customizable Cuff
with Easy
Cut Lines for a
Perfect Fit

Wet/Dry Use



REGULAR
Part # - APRON2LSR

SMALL
Part # - APRON2LSS

APRON

MULTI-PURPOSE
APRON



- Rubber Cuffs Provides Full Coverage
- Bright Neon Yellow Color Provides Greater Visibility
- Perfect for Wet or Dry Environments
- Protects From Dust, Water and Other Chemicals
- Dual-Adjustable Clips Makes For A Perfect Fit



Dual-Adjustable Clips Makes for a Perfect Fit

PART NO.	SIZE	TYPE	DESCRIPTION
APRON2LSR	55"L X 60"W	Long Sleeve	Multi-Purpose Waterproof Apron (Regular)
APRON2LSS	42"L X 41"W	Long Sleeve	Multi-Purpose Waterproof Apron (Small)

APRON

MULTI-PURPOSE
APRON SLEEVELESS



- Sleeveless with Wide Straps for Ease and Comfort
- Bright Neon Yellow Color Provides Greater Visibility
- Perfect for Wet or Dry Environments
- Protects From Dust, Water and Other Chemicals
- Dual-Adjustable Clips Makes For A Perfect Fit



Dual-Adjustable Clips Makes for a Perfect Fit

PART NO.	SIZE	TYPE	DESCRIPTION
APRON2000	55"L X 60"W	Sleeveless	Multi-Purpose Waterproof Apron (One Size Fits All)

G-TAPE

**ALL PURPOSE
PROTECTION & REPAIR TAPE**



Nichigo *G-Tape*

INNOVATIVE
SOLUTIONS

- LDPE film _____
- HDPE cloth _____
- LDPE film _____
- Acrylic PSA layer _____



All G-Tape™ products feature a patented combination of solvent acrylic adhesive with an advanced backing substrate that results in unmatched performance.



MULTI-PURPOSE APPLICATIONS



Multi-Purpose Tape

Multi-Purpose Surface Protection and Repair Tape



- Hand Tearing-Straight and Easy
- Residue Free Removal
- Waterproof
- All-Weather Usage (-40°F to +200°F)
- Repositionable
- Highly Weather/UV Resistant
- Good Surface Protection
- Great for Quick Repairs

PART NO.	COLOR	SIZE	RECOMMENDED FOR
GT1009GR	Green	2" x 164'	Multi-Purpose - All Surfaces

Extra UV Protection

Multi-Purpose Surface Protection and Repair Tape



- Hand Tearing-Straight and Easy
- Residue Free Removal
- Waterproof
- All-Weather Usage (-40°F to +200°F)
- Repositionable
- Highly Weather/UV Resistant
- Good Surface Protection
- Great for Quick Repairs

PART NO.	COLOR	SIZE	RECOMMENDED FOR
GT1008SW	White	2" x 164'	Extra UV Protection

Acrylic Flashing Tape

High Adhesion Acrylic Flashing Tape



- Perfect Flashing for Windows, Doors, & Deck Beams
- Hand Tearing-Straight and Easy
- Waterproof
- All-Weather Usage (-40°F to +200°F)
- Highly Weather/UV Resistant
- AAMA 7-11 Level 3 Class A Certified
- Great Performance and Ease of Use
- Cleanly Removes from Face-to-Face Adhesive Contact
- Available as a single roll or by the case

***Permanent Adhesion**

PART NO.	COLOR	SIZE	RECOMMENDED FOR
GT3040BK02	Black	2" x 65'	Acrylic/Flashing- All Surfaces
GT3040BK04	Black	4" x 65'	Acrylic/Flashing- All Surfaces
GT3040BK06	Black	6" x 65'	Acrylic/Flashing- All Surfaces
GT3040BK09	Black	9" x 65'	Acrylic/Flashing- All Surfaces
GT3040BK12	Black	12" x 65'	Acrylic/Flashing- All Surfaces

Surface Protection

Repositionable Waterproof Surface Protection Tape



- Protects Surfaces from Scratches, Stains and Etching
- Applicable for All Stone Faces Including Marble and Limestone
- Can Be Used for Wet and Dry applications
- Easily Mark Tape with Ball Point Pen, Permanent Marker, China Marker, etc.

PART NO.	COLOR	SIZE	RECOMMENDED FOR
BAB0650	Black	6" x 164'	Large Surface Protection

TILE LEVELING SYSTEM

EZ CLICK SYSTEM

NEXT-GENERATION SCREW-BASED TILE LEVELING SYSTEM



- Instant Screw Ejection Leveling System
- Supports Tile Thickness: 1/8" to 25/32" (3mm to 20mm)
- Levels and Spaces at The Same Time
- Tightens by Hand (No Tools Required)
- Minimum joint calibration: 1/32" (1mm)
- Ideal for Floor
- Proprietary Scratch-Prevention Edge
- Built-in spacer calibration: 1/32" (1mm), & 5/32" (4mm)
- *Patent Pending Design

Tightens and Releases by Hand
(No Tools Required)

The Quick and Reliable Leveling Cap



PART NO.	SIZE	TYPE	COLOR	QTY
EZCLICKCP		Screw Cap	Black	50
EZCLB10W2	1/32" (1.0mm) (2cm Tall)	Linear Joint Screw Base	White	200
EZCLB40B2	5/32" (4.0mm) (2cm Tall)	Linear Joint Screw Base	Black	200

RSR-2000

RUST STAIN REMOVER IN GEL FORM



- Removes Common Rust Stains From Natural Stone Surfaces, Concrete, Brick, Terra Cotta, Mexican Tile, or Other Hard Porous Surfaces
- Specially Formulated To Work Extremely Fast
- Non-Hazardous Chemical Is Safe To Use and Will Not Harm The Environment
- Use On Floors, Countertops, Vertical Surfaces and Exterior Areas
- Available in 14oz Tube or Trial Size 1.4oz Bottle
- Tube Covers Approximately 4 sqft



PART NO.	SIZE	CONTAINER
RSR-400G	14 oz. (400g)	Tube
RSR-040G	1.4 oz. (40g)	Bottle

Index

A

Adapter Hose 57
Air Hose 56
AIR-300 15
AIR-830 / AIR-834 16
Antique Brush Wheels 48
Apron 61

B

Blademaster 36

C

Ceramica EX 47
Contour Blade
 Granite & Eng. Stone 33
 Marble 33
 Porcelain/Cryst. Glass 32
Countertop Trim Kit 12

D

Dressing Stick 37
Drill Bit Guide 44
Dry Core Bits 42

E

ECC-125 13, 14
ECC-KIT 14
Eclipse II 25
Eclipse Q 25
Ecoguard C 50
Ecoguard CD 51
Ecoguard D 50
Ecoguard G Series 51
Ecoguard W Series 52
Electroplated Drill Bits 43
ESC-125 10
Exhaust Hose 57
EZ Click System 66

F

Flange Adapter 37
Flexible Backer Pad 53

G

Ground Fault
Circuit Interrupter 54
G-Tape 63
GV Backer Pads 53

H

Hand Pads 46
Hoses 56
Hot-Rod 34

K

Katana 26

M

Manifold System 55
Mobile Hose 57

P

Paver Tile Bullnose Kit 22
Plus 24
Pool Coping Kit 60
Porcellana 28
Porcellana For PRS 28
Profilers
 B-Series 39
 V-Series 40
 Z-Series 39
PSC-600 8
PSG-658 6
PT Cutter 35

Q

Q-Cut 27
Quad 24
Quad Adapters 37

R

Rescue 36
Rigid Backer Pad 53
Rotary Backer Pad 20
RSR-2000 66
Rust Inhibitor Oil 54

S

Sandpaper 47
Spike Ruler 37

U

Ultracut
 APR Series 31
 GPM Series 26

V

Vacuum Brazed
 Trimmer Bit 43
VDP-700 18
 Rotary Backer Pad 20
 Wool Pads 20
Vetro 29
Vetro For PRS 29
Vortex
 For Granite 30
 For Marble 30
VSP-320 21

W

Water Hose 57
Wet Blade Cutting Kit 58
Wet Core Bits 42
Wet Sanding/Polishing Kit 59
Wool Pads 20

Product Literature Catalogs

Alpha® provides product catalogs for all products to best serve the particular needs of our customers. Catalogs are available for applications such as Hand Tooling and Large Machine Tooling, as well as for specific industries such as stone, tile, construction, industrial, automotive, composites, glass and marine.

All of our catalogs are a convenient portable of size 5.5" x 8.5", and illustrate the tools and accessories needed for Cutting, Profiling, Grinding, Drilling, Polishing and Restoring all types of materials.

To request these catalogs, or for more information about our product line, visit our website at www.alpha-tools.com or contact us at 800-648-7229.



ALPHA® TOOL REPAIR

- Authorized repair centers available
- All tool repairs carry a 30-day warranty
- Quick turn-around time
- Technical support for repair and maintenance
- Order replacement tool parts directly from Alpha®
- Loaner program available

Visit our website to find a local center



Let's get social...



We are ready to connect with you on your favorite social media sites... Join Us Today!

 **Alpha Professional Tools®**

103 Bauer Drive • Oakland, NJ 07436
800-648-7229 • Fax: 800-286-0114

www.alpha-tools.com

