

ALPHA®

TOOLS FOR
TILE & STONE
CONTRACTORS

CUTTING, PROFILING & POLISHING

PROVIDING BETTER
SOLUTIONS
TO THE
PROFESSIONAL



VERSION 4



W E L C O M E

Alpha Professional Tools® was founded in 1986 and has become a leading manufacturer of quality tools for professionals in the natural/ engineered stone, porcelain, ceramic, glass, construction, marine and automotive industries. Alpha® provides the best products for cutting, drilling, shaping and polishing all types of materials.

In addition to providing the best products in the industry, Alpha Professional Tools® offers a variety of services to support their products.



*Alpha Professional Tools® product line and pricing is subject to change at any time.
Alpha® is not responsible or liable for typographical errors.*

CONTACT US



Visit us on the web at:
www.alpha-tools.com

COMPANY INFORMATION

**103 Bauer Drive
Oakland, NJ 07436**

Hours of Operation:
8:30 a.m. – 5:00 p.m. EST

Telephone Number: 201-337-3343
Toll-Free Number: 800-648-7229
Fax Number: 201-337-2216

Customer Service Fax Number: 800-286-0114
Tool Department Fax Number: 201-337-2265
Accounting Department Fax Number: 201-337-2262

E-mail orders to: orderdesk@alpha-tools.com
E-mail Spare Parts orders to: tooldesk@alpha-tools.com
Technical Support: technicalsupport@alpha-tools.com

SALES CONTACTS BY TERRITORY:

Caribbean	201-337-3343	Sales-Caribbean@alpha-tools.com
Canada	519-505-7900 / 226-931-4166 / 519-546-9861	Sales-Canada@alpha-tools.com
Central Plains	800-648-7229	Sales-CentralPlains@alpha-tools.com
Florida	786-570-4350	Sales-Florida@alpha-tools.com
International	201-337-3343	Sales-International@alpha-tools.com
Mid-Atlantic	804-382-5357	Sales-Mid-Atlantic@alpha-tools.com
Midwest	630-849-7105	Sales-Midwest@alpha-tools.com
Mountain	480-848-6808	Sales-Mountain@alpha-tools.com
New England	860-933-6626	Sales-NewEngland@alpha-tools.com
Northern CA	925-428-1292	Sales-NorthernCA@alpha-tools.com
Northwest	800-648-7229	Sales-Northwest@alpha-tools.com
NY Metro	973-830-7681	Sales-NYMetro@alpha-tools.com
Ohio Valley	440-364-3759	Sales-OhioValley@alpha-tools.com
Pacific	800-648-7229	Sales-Pacific@alpha-tools.com
South	713-252-9851	Sales-South@alpha-tools.com
Southeast	678-977-1147	Sales-Southeast@alpha-tools.com
Southern CA	714-853-3476	Sales-SouthernCA@alpha-tools.com

TOOLS

STONE CUTTER

- PSC-600, High-Performance Pneumatic Stone Cutter 4
- ESC-125, Wet Stone Cutter 5
- Countertop Trim Kit 7
- PSC-150 Miter Cutting Kit 8
- PSC-150, Pneumatic Stone Cutter 10
- AWS-110, Wet Stone Cutter 11
- ECC-125, Ecocutter 12
- ECC-KIT, Dry Porcelain Paver Tile Cutting System 13

GRINDERS

- PSG-125 14
- PSG-125 Diamond Cutting Kit 16
- PSG-125 Grinding Kit 16

POLISHERS

- VDP-700 Variable Speed Rotary Polisher 17
 - Wool Pads 19
 - Rotary Backer Pads 19
 - Diamond Face Foam Pads 20
- VSP-320, Variable Speed Wet Polisher 21
- Tile Bullnose Kit 22
- WDP-320, Wet/Dry Polisher 23
- AIR-300, Mini Pneumatic Polisher 24
- AIR-830 / 850, High Performance Pneumatic Polishers 25
- Beveling Auxiliary Base 27
- Beveling Base Starter Kit 28
- Beveling Base Applications 29

CUTTING

- Cutting System Overview 30

DRY BLADES

- Plus 31
- Quad 31
- Eclipse II 32
- Eclipse Q 32
- Katana 33
- Tuckpoint 34
- Libero 35
- Trim Master 35
- Ultracut GPM Series 36
- Ultracut APR Series 36

WET BLADES

- Laminam 37
- Sonic 37
- Vetro 38
- Vetro for PRS 38
- Porcellana 39
- Porcellana for PRS 39
- Q-Cut 40
- Cordless Saw Blade for Ceramic Tile 41
- Cordless Saw Blade for Glass 41

TABLE OF CONTENTS

- Vortex for Granite42
- Vortex for Marble42
- Contour for Porcelain43
- Contour for Granite & Engineered Stone44
- Contour for Marble44
- Hot-Rod45
- Groove Cutter46
- Marble Profile Wheel46
- BladeMaster47
- Rescue47

BLADE ACCESSORIES

- Quad Adapters48
- Flange Adapters48
- Spike Ruler48
- Dressing Stick48
- Guide Rails49
- EZ Thin Tile Cutters50

PROFILING

- Profiler B-Series51
- Profiler F-Series51
- Profiler V-Series52
- Profiler Z-Series52

GRINDING & SANDING

SURFACE GRINDING

- Spike Disc53
- Vextra Flat Disc54

EDGE GRINDING

- Vexcel Rigid Disc55
- DW Style Grinding Wheel56
- DS Style Grinding Wheel56

SANDING

- VFlex Sanding Disc57
- Sandpaper58

POLISHING

DIAMOND PADS

- Ceramic Three-Part Polishing System59
- Ceramica Vitrified60
- Ceramica Metal60
- Ceramica Resin61
- Ceramica EX61
- Ceramica Buff62
- Ceramica TF62
- Kirara63

TABLE OF CONTENTS

DRY POLISHING DISCS

• Ceramica Dry	64
• Hand Pads.....	64
• PVA VP	65
• PVA MS Style	66
• PVA QC Style	67

POLISHING WHEELS

• Turboshine.....	68
• Turboshine for Crystallized Glass.....	69
• Antique Brush Wheels.....	70
• Felt Wheels	70

BACKER PADS

• Rigid Backer Pads.....	71
• Flexible Backer Pads.....	71
• GV Backer Pads.....	71

DUST COLLECTION COVERS

• Ecoguard C	72
• Ecoguard D	72
• Ecoguard CD.....	73
• Ecoguard G	73
• Ecoguard W Series	74

DRILLING

• Wet Core Bits	75
• Dry Core Bits.....	75
• Trimmer Bits	76
• Electroplated Drill Bits	76
• Drill Bit Guide	77

ACCESSORIES

• EZ Wedge System.....	78
• EZ Click System	79
• Manifold System.....	80
• Air Hose (AIR-680 / AIR-830 / AIR-850 / PSC-600)	82
• Water Hose (AIR-680 / AIR-830 / AIR-850 / PSC-600)	82
• Air Hose (PSC-150 & PSG-125)	82
• Water Hose (PSC-150).....	83
• Adapter Hose	83
• Mobile Hose	83
• Exhaust Hose	83
• HEPA Wet/Dry Vacuum	84
• Apron.....	85
• WBC9KIT.....	87
• Wet Blade Cutting Kits.....	88
• Wet Sanding / Polishing Kit.....	88
• Corner Nippers	89
• Corner Rulers	90
• Dust Carriage	91
• Gloss Checker.....	91
• Safety Glasses	91
• GFCI (Ground Fault Circuit Interrupter).....	91
• G-Tape.....	92
• Stain Removers.....	95

PNEUMATIC CUTTER

PSC-600

HIGH-PERFORMANCE PNEUMATIC STONE CUTTER



- Center Water-Feed System to Deliver Ample Water Regardless of Position
- 15ft. All-Weather Hoses with Flexibility Down To -40°F Or +140°F(-40°C To +60°C)
- Newly Developed Motor Produces More Power
- Lightweight and Ergonomically Designed for Better Maneuverability
- Composite End Case to Prevent Freezing Hands
- Silicon Gear Head Cover Provides Cushion and Keeps Hands Warm
- Enhanced Spindle Shaft for Easy Tool Removal (Wrench included)
- One Year Warranty (See manual for details)

SPECIFICATION	DATA
Model	PSC-600
Air Pressure	85 PSI (6 Bar)
Air Consumption	15 CFM (425L/min)
Weight	2.9 lbs (1.3 kgs)
No Load RPM	8,500 RPM
Air Inlet	1/4" BSPP
Water Inlet	1/8" BSPP
Arbor	7/8" (22mm)
Cutting Disc Diameter	6" (150mm)
Length	7-1/2" (190.5mm)
*To control the amount of CFM required, use the reduced flow air inlet fitting 3001-0084	

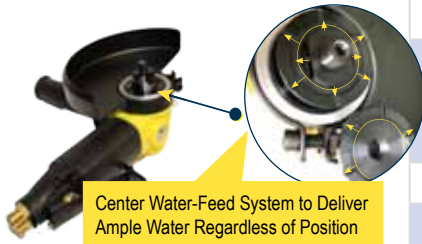

ITEM	QUANTITY
Air Hose (15ft / 4.5m)	1
Water Hose (15ft / 4.5m)	1
Side Handle (reversible)	1
Rust Inhibitor Oil (6.7oz/200ml)	1
Screw (w/O-Ring Seal for Oil Port)	1
Exhaust Hose & Clamp	1
Spring Washer	1
6" Safety Guard	1
Double End Wrench (19mm/22mm)	1
Phillips Screwdriver	1
Water Quick Coupler w/Shut-off Valve	1
O-Ring (O-Ring for Water Valve Repair)	1
Single Open End Wrench (22mm)	1
Hex Wrench (6mm)	1
Inner Flange for Cutting	1
Outer Flange	1
L-Bracket	1
Inner Flange for Grinding	1

PART NO.	MAXIMUM RPMS	RECOMMENDED FOR	DESCRIPTION
PSC-600	8,500	Cutting	Pneumatic Stone Cutter
AIR-008		Pneumatic Tools	Rust Inhibitor Oil 8oz (237ml)

Introducing A New and Improved
Version of Our Popular **AWS-125...**

ALPHA[®]

ESC-125

WET/DRY STONE CUTTER

OSHA[®]
COMPATIBLE

DRY

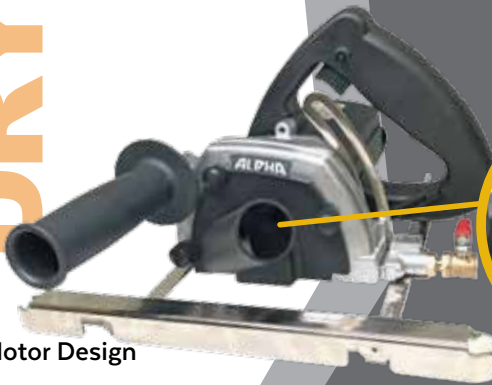

Dust Cover For HEPA
Vacuum Connection



- New Motor Design
- Kink Free Hybrid Water Supply Hose with Quick Change Connector

WET



Newly Designed
Water Jet



*Blade not included



GUIDE RAIL

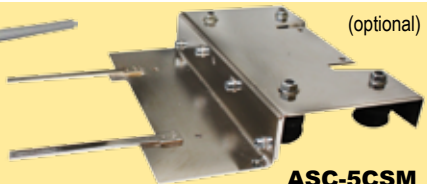

(optional)

ASC-5CSM

STONE CUTTER

ESC-125

WET/DRY STONE CUTTER



- Precision Cuts Everytime
- Powerful Motor For Use On Granite, Quartz Surfaces, Marble, Limestone, Concrete and Sintered Slabs
- Water-Feed Supply Eliminates The Harmful Dust Particles
- Base Plate Allows Guides To Be Used in Multiple Ways
- Dust Cover for HEPA Vacuum Connection
- New Clamping System Ensures Cutting Stability
- Included Self-Stick Felt Strips Protects The Work Surface From Scratches
- Built-In GFCI (Ground Fault Circuit Interrupter)
- Great For Use With Curve Cutting Blades
- One Year Warranty (See manual for details)

SPECIFICATION	DATA
Model	ESC-125/ESC-225
Rating	110 Volts/220 Volts
Amperage	11.2A/5.5A
Power	1200W
No Load Speed (min-1)	12,000 RPM
Weight	8.9 lbs (4.0 kgs)
Arbor	7/8" (22.23mm)
Cutting Disc Diameter	5" (125mm)
Plug Type	A (110V)
Cord	15ft (4.5m) Single-Phase
Max. Cutting Depth	1-5/8" (41mm)

ITEM	QUANTITY
Dust Cover	1
Knob Bolt	3
TT Ruler Guide	1
Water Hose Assembly	1
Quick Connect Adapter	1
Side Handle	1
Screw (M6x30-Left)	1
Flange 3	1
Carbon Brush Set	1
T-Handle Wrench	1
Open-End Wrench (22mm)	1
Self-stick Felt Strip Set	1
GFCI	1
EasyOn-EasyOff Sleeve	1
SS Flat Head Screw (M4x10)	3
Water Valve Assembly	1

PART NO.	SIZE	TYPE	ARBOR(S)	DESCRIPTION
ESC-125	5"	110V	7/8" (22.23mm)	Wet/Dry Stone Cutter
ESC-225	5"	220V	7/8" (22.23mm)	Wet/Dry Stone Cutter

COUNTERTOP TRIM KIT

**COMPLETE TRIM KIT
FOR A CUSTOM-LOOK**

Part number: 5480-4150



**COUNTERTOP
TRIM KIT**



**Complete
Trim Kit for a
Custom Look**

INCLUDES:

Wet/Dry Stone Cutter
ESC-125

5" Eclipse Blade
DEE005

**5" Carriage Assembly
for Stone Cutter**
ASC-5CSM

4' Guide Rail with Clamps
ASC-GR04

- Recommended for Hard Surfaces
- Eclipse II Blade has 8mm Tall Diamond Layer for a Long Life
- Perfect for your Stone Tile Application
- High-End General Purpose Turbo Blade for Stone Fabricators
- Consistent Performance without Chipping
- Kit Contains: ESC-125 Stone Cutter, 5" Carriage Assembly, 5" Eclipse II Blade and 4' Guide Rail
- One Year Tool Warranty (*See manual for details*)

PART NO.	DESCRIPTION
5480-4150	Countertop Trim Kit (ESC-125)

PSC-150

MITER CUTTING KIT

STEP 1
Set Up
Guide Rail

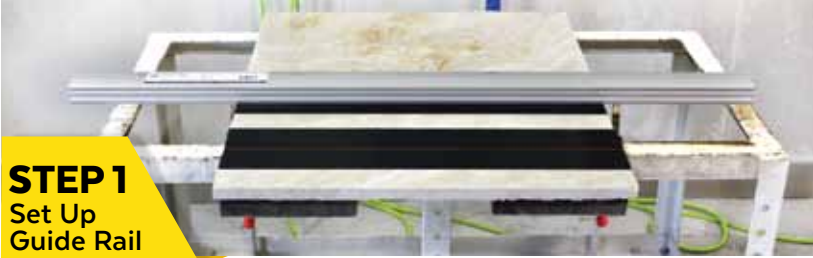

STEP 2
Miter Cut
One

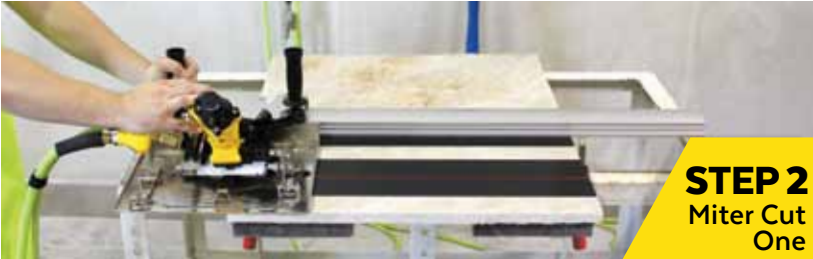

STEP 3
Miter Cut
Two



**SAVE TIME & INCREASE
PRODUCTIVITY**

PART NUMBER: 5480-5100

Kit includes: (2) PSC-150, (2) ASC-6CSM, ASC-GR04, ASC-GR07, ASC-GR12, BAB0650

PSC-150 MITER CUTTING KIT

COMPLETE MITER CUTTING KIT FOR A WATERFALL EDGE

Part number: 5480-5100



A Complete Miter Cutting Kit For That Perfect Waterfall Edge

INCLUDES:

- Pneumatic Stone Cutter**
(2) PSC-150
- 6" Carriage Assembly for Pneumatic Stone Cutter**
(2) ASC-6CSM
- Guide Rails with Clamps**
4', 7', 12' (Connector & 4 Screws)
ASC-GR04 | ASC-GR07 | ASC-GR12
- Surface Protection Tape**
BAB0650

- One System for Straight, Curve and Miter Cuts
- One-Time Easy Setup on the Guide Rail Allows for Two Different Miter Cut Positions for Lamination Prep
- Precise Miter Cutting for Laminated Waterfall Edges and Book Matching
- Miter Cut 3/4" (2cm) Material with Ease

PART NO.	DESCRIPTION
5480-5100	Miter Cutting Kit (PSC-150)

STONE CUTTER

PSC-150

PNEUMATIC STONE CUTTER



- 2 HP Pneumatic Powered Motor with Speed Governor
- Capable of Miter Cutting 1-1/4" Material With Ease
- Kink-Free Water and Air Hoses for Easy Maneuverability and Reducing Operator Fatigue
- Great For Sink-Hole Cutting, Groove Cutting and Rodding Applications
- Comes With An Eclipse II 6" Blade and a Bottle of Rust Inhibitor Oil
- Can Be Used Wet or Dry
- One Year Warranty (*See manual for details*)

SPECIFICATION	DATA
Model	PSC-150
Air Pressure	90 PSI
Air Consumption Min	32 CFM / 1HP*
Air Consumption Max	48 CFM / 2HP
No Load RPM	8,500 RPM
Air Inlet	3/8" NPSM
Water Inlet	1/4" BSPP
Arbor	7/8" (22mm)
Max. HP	2.0HP
Cutting Disc Diameter	6" (150mm)
*To control the amount of CFM required, use the reduced flow air inlet fitting 3001-0084	

 **2,000 Hour
Duty Cycle**

ITEM	QUANTITY
Flanges	3
Bolts (M6X30 Left) / (M6x20 Left)	2
Side Handle	1
Combination Wrench (9mm)	1
Hex Wrench (5mm)	1
Open End Spanner Wrench (22mm)	1
Air Hose (15ft / 4.5m)	1
Water Hose (15ft / 4.5m)	1
Rust Inhibitor Oil (8oz / 237ml)	1
Alpha® Eclipse II 6" Blade (DEE006)	1
Reduced Flow Air Inlet Fitting (3001-0084)	1

PART NO.	SIZE	RECOMMENDED FOR	ARBORS/ RPMS	DESCRIPTION
PSC-150	6"	Granite/Engineered Stone	7/8", 22mm	Pneumatic Stone Cutter
DEE006	6"	2.1mm	10,100	7/8", 5/8", ∅
AIR-008		Pneumatic Tools		Rust Inhibitor Oil 8oz (237ml)
5480-5100				PSC-150 Miter Cutting Kit

STONE CUTTER

AWS-110

WET STONE CUTTER



- Produces Straight and True Cuts Everytime
- Powers Through Hard Dense Materials, Such As, Porcelain, Hard Red Granites and Engineered Stone
- Water-Feed Supply Eliminates The Harmful Dust Particles
- Base Plate Allows Guides To Be Used in Multiple Ways
- Included Self-Stick Felt Strips Protects The Work Surface From Scratches
- Built-In GFCI (Ground Fault Circuit Interrupter)
- *One Year Warranty (See manual for details)*



SPECIFICATION	DATA
Model	AWS-110/AWS-220
Rating	110/220 Volts
Amperage	11.2A (5.5A)
Power	1200W
No Load Speed (min-1)	13,000 RPM
Weight	6.8 lbs (3.1 kgs)
Arbor	20mm
Cutting Disc Diameter	4" (100mm), 4-1/2" (115mm)
Maximum Cutting Depth	1-1/4" (32mm)

ITEM	QUANTITY
Ground Fault Circuit Interrupter	1
Water Valve and Hose	1
Water Attachment Assembly	1
Spanner Wrench M22	1
TT Ruler Guide	1
T-Handle Wrench	1
Extra Carbon Brush Set	1
Self-stick Felt Strip Set	1

PART NO.	SIZE	TYPE	ARBOR(S)	DESCRIPTION
AWS-110	4-1/2"	110V	20mm	Wet Stone Cutter
AWS-220	4-1/2"	220V	20mm	Wet Stone Cutter

STONE CUTTER

ECC-125

ECOCUTTER



- Virtually Dust-Free
- Portable Cutting System
- Accurate Cutting Performance
- Eliminates Downtime
- Built-in In-line circuit breaker
- Great for Grout Removal, Crack Chasing & Concrete Profiling
- One Year Warranty (*See manual for details*)

SPECIFICATION	DATA
Model	ECC-125
Rating	110 Volts
Amperage	11.2A
Power	1200W
No Load Speed (min-1)	12,000 RPM
Weight	9.5 lbs (4.3 kgs)
Arbor	7/8" (22.23mm)
Cutting Diameter	5" (125mm)
Maximum Cutting Depth	1-1/8" (29mm) (Without Ecocutter Table)

ITEM	QUANTITY
Dust Hose	1
Dust Gate	1
Side Handle	1
Hexagon Ring Spanner	1
Wrench	1
Dust Bag	1
TT Ruler	1
Hook & Loop Strap	2

PART NO.	SIZE	TYPE	ARBOR(S)	DESCRIPTION
ECC-125	5"	110V	7/8" (22.23mm)	Ecocutter
133544	17" x 13-1/2" x 12"			Dust Bag w/strap
ECO-CARS		Steel		Dust Bag Carriage (includes Dust Bag)

DUST BAG CARRIAGE



ECC-KIT

DRY PORCELAIN PAVER TILE CUTTING SYSTEM

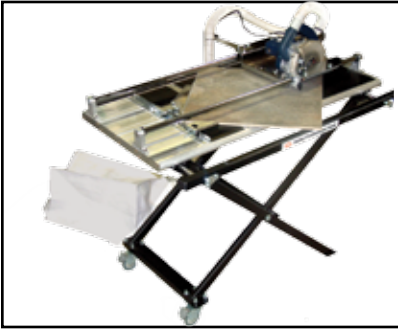

- Virtually Dust-Free
- Portable Cutting System
- Accurate Cutting Performance
- Eliminates Downtime and The Messy Cleanup
- Built-In Breaker Assembly
- Holds 3/4" Thick Porcelain Paver Tile
- One Year Tool Warranty (*See manual for details*)

SPECIFICATION	DATA
Model	ECC-KIT (ECC-125)
Rating	110 Volts
Amperage	11.2A
Power	1200W
No Load Speed (min-1)	12,000 RPM
Weight	9.5 lbs (4.3 kgs)
Arbor	7/8" (22.23mm)
Cutting Diameter	5"(125mm)
Maximum Cutting Depth	1-1/8" (29mm) (without Ecocutter Table)

EQUIPMENT INCLUDED	QUANTITY
ECC-125	1
Dust Hose	1
Dust Gate	1
Side Handle	1
Hexagon Ring Spanner	1
Wrench	1
Dust Bag	1
TT Ruler Guide	1
Hook & Loop Strap	2
Ecocutter Table	1
Ecocutter Stand	1
Alpha® Ultracut GPM 5"	1

PART NO.	SIZE	TYPE	ARBOR(S)	DESCRIPTION
ECC-KIT	5"	110V	7/8" (22.23mm)	Dry Cutting System
ECC-125	5"	110V	7/8" (22.23mm)	Ecocutter
133544	17"x13-1/2 x 12"			Dust Bag w/strap
ECC-STAND				Dry Cutting System Stand
ECC-TABLE				Dry Cutting System Table
170005				Ecocutter DVD
PART NO.	SIZE	THICKNESS	MAX RPM	ARBOR(S)
GPM0578	5"	1.5mm	12,200	7/8"

HIGH-PERFORMANCE PNEUMATIC GRINDER



**INDUSTRIAL
QUALITY**



SINKHOLE CUT-OUT



GRINDING



RODDING



FLUSH CUTTING



PSG-125

PNEUMATIC GRINDER



- Powerful 1.4 HP motor with speed control governor
- Compact ergonomic aluminum body
- Reversible safety lever throttle
- Two auxiliary handle positions
- Built-in oil port for daily maintenance
- Adjustable rotating exhaust
- Wet cutting kit available
- One Year Warranty (See manual for details)

SPECIFICATION	DATA
Model	PSG-125
Air Pressure	90 PSI
Air Consumption	33 CFM / 934L/min
No Load Speed	12,000 RPM
Weight	4.6 lbs / 2.1 kgs
Length	11-3/4" / 298mm
Air Inlet	3/8" NPSM
Spindle	5/8"-11
Max. Disc Capacity	5" x 1/4" x 7/8"
Max. HP	1.4 HP

WET BLADE CUTTING KITS (optional)



WBCKIT(5" & 6")

WBC9KIT



ITEM	QUANTITY
Blade Safety Guard	1
Lock Nut with 7/8" Arbor	2
Inner Flange	2
Side Handle	1
Pin Wrench	1
Double End Wrench (1" / 32mm)	1
Handle Bracket	1
Washer and Seal Set	1
Screw	1
Rust Inhibitor Oil (8oz / 237ml) (AIR-008)	1
Air Hose Assembly (15ft / 4.5m)	1



PART NO.	SIZE	ARBOR(S)	DESCRIPTION
PSG-125	5"	7/8"	Pneumatic Grinder

PSG-125

DIAMOND CUTTING KIT



*(Blade not included)

- Fits wide kerf blades for tuck pointing, crack chasing and grout removal
- Compact ergonomic aluminum body
- Reversible safety lever throttle
- Two auxiliary handle positions
- Adjustable rotating exhaust
- One Year Tool Warranty (*See manual for details*)

PART NO.	DESCRIPTION
5480-1301	PSG-125 Diamond Cutting Kit

PSG-125

DUST-FREE GRINDING KIT



*(Grinding Wheel not included)

- Great for surface preparation on concrete, wood, composite or other surfaces
- Compact ergonomic aluminum body
- Powerful 1.4 HP motor with speed control governor
- Reversible safety lever throttle
- Adjustable rotating exhaust
- Removable flat cover allows grinding right to the edge
- One Year Tool Warranty (*See manual for details*)

PART NO.	DESCRIPTION
5480-1302	PSG-125 Grinding Kit

HEPA WET DRY VACUUM

**HEAVY DUTY
WORKHORSE**
for all your
needs!



(optional)

VDP-700

VARIABLE SPEED ROTARY POLISHER



Spindle Lock



*Backer and Pad Not Included



(OPTIONAL)

POOL COPING KIT

KIT Part # 5480-6100

This block displays the optional Pool Coping Kit. It includes the VDP-700 polisher, a backer, several polishing pads, a power cord, and a manual. The kit is presented as a collection of items against a white background.

VDP-700

WET/DRY VARIABLE SPEED ROTARY POLISHER



- Variable Speed 700-3500 RPM with Soft Start
- Designed For The Polishing Professional
- Heavy-Duty Precision Gear System
- Powerful 11.0 Amp (rated) Motor
- Built-in Speed Stabilizer for Constant Speed Output
- Configured with A Long-life Motor and Carbon Brushes
- 25ft. 14 AWG Electrical Power Cord
- Lightweight for Better Manueverability
- Industrial Quality Polisher
- C-Handle & Side Handle for User Convenience
- One Year Warranty (*See manual for details*)

SPECIFICATION	DATA
Model	VDP-700
Rating	120 Volts
Amperage	11.0A
Power	1250W (Rated), 1900W (Maximum)
No Load Speed (Variable)	700~3500 RPM w/Soft Start
Weight	6.4 lbs (2.9 kgs)
Spindle	5/8"-11
Power Supply	Single-phase AC, 50/60Hz
Plug Type	A (120V)
Cord	25ft (7.6m) (14 AWG)
Backing Plate Size	7" (178mm) (Maximum)
Polishing Disc Size	9" (228mm) (Maximum)

ITEM	QUANTITY
Spanner Wrench	1
Hex Wrench	1
C-Handle w/Mounting Screws	1
Side Handle	1
Extra Carbon Brush Set	1



PART NO.	SIZE	MAXIMUM RPM	TYPE	DESCRIPTION
VDP-700	7"	700-3500	120V	Variable Speed Rotary Polisher

WET SANDING/ POLISHING KIT

KIT Part # WSPKIT



WOOL PADS

REMOVES DEEP SCRATCHES WITH EASE



- Removes Deep Scratches, Overspray & Severe Swirl Marks With Ease
- Premium Performance and Heat-Resistant
- Smoother Handling and Reduced Vibration
- For Use on Rotary Polishers
- Great for Heavy Oxidation

PART NO.	SIZE	TYPE	RECOMMENDED FOR	MATERIAL	GRIT
WP003160	3"	Hook & Loop	Heavy Cutting	High-Nap Knitted Wool	T160
WP006160	6"	Hook & Loop	Heavy Cutting	High-Nap Knitted Wool	T160
WP007160	7"	Hook & Loop	Heavy Cutting	High-Nap Knitted Wool	T160

ROTARY BACKER PAD

FOR USE ON ROTARY POLISHERS



- Soft Molded Urethane With Flexible Edge
- Urethane Backing Makes for Greater Flexibility and Excellent Polishing
- Ideal for Contour Polishing
- For Use with Foam, Wool & Microfiber Pads
- Hook & Loop Allows for Fast Pad Changes
- Well Balanced for Smooth Polishing
- Absorbs Vibrations and Has Great Rebound Performance



Hook & Loop



Adhesive

PART NO.	SIZE	TYPE	RECOMMENDED FOR	THREADS
MP358HL	3"	Hook & Loop	Foam, Wool & Microfiber Pads	5/8"-11
MP558HL	5"	Hook & Loop	Foam, Wool & Microfiber Pads	5/8"-11
MP658HL	6"	Hook & Loop	Foam, Wool & Microfiber Pads	5/8"-11
MP758HL	7"	Hook & Loop	Foam, Wool & Microfiber Pads	5/8"-11
MP858HL	8"	Hook & Loop	Foam, Wool & Microfiber Pads	5/8"-11
MP858GL	8"	Adhesive	Foam, Wool & Microfiber Pads	5/8"-11

DIAMOND FACE FOAM PADS

DESIGNED FOR BOTH
ROTARY & DA POLISHER



DIAMOND FACE FOAM PADS

- **DESIGNED FOR BOTH ROTARY & DA POLISHERS**
- **REDUCED POLISH SPLASH AND HEAT BUILD-UP**
- **SMOOTHIER HANDLING AND REDUCED VIBRATION**
- **CAN WITHSTAND HIGH TEMPERATURES AND WATER WASH**
- **GREAT FOR USE ON SCRATCH RESISTANT/CERAMIC PAINTS**

PART NO.	SIZE	TYPE	COLOR	RECOMMENDED FOR	GRIT
FPG04120	4"x1"	Hook & Loop	Green	High Cutting	T120
FPG06120	6"x1"	Hook & Loop	Green	High Cutting	T120
FPG07120	7"x1"	Hook & Loop	Green	High Cutting	T120
FPY04080	4"x1"	Hook & Loop	Yellow	Medium Cutting	T80
FPY06080	6"x1"	Hook & Loop	Yellow	Medium Cutting	T80
FPY07080	7"x1"	Hook & Loop	Yellow	Medium Cutting	T80
FPB04020	4"x1"	Hook & Loop	Black	Finishing/Polishing	T20
FPB06020	6"x1"	Hook & Loop	Black	Finishing/Polishing	T20
FPB07020	7"x1"	Hook & Loop	Black	Finishing/Polishing	T20
FPR04010	4"x1"	Hook & Loop	Red	Finishing/Finishing	T10
FPR06010	6"x1"	Hook & Loop	Red	Finishing/Finishing	T10
FPR07010	7"x1"	Hook & Loop	Red	Finishing/Finishing	T10

VSP-320

**VARIABLE SPEED
WET POLISHER**



- Variable Speed 700-2500 RPM
- Heavy-Duty Gear System with Step-Down Transmission
- 15ft. Flexible All-Weather Water Hose
- 15ft. Electrical Power Cord Has An Inline GFCI
- EasyOn-EasyOff Sleeve Improves Maneuverability
- Adjustable Splash Guard
- Center Water-Feed System
- Ventilation Cap Diverts Water from Getting Into Motor Housing
- C-Handle & Side Handle for User Convenience
- One Year Warranty (See manual for details)

SPECIFICATION	DATA
Model	VSP-320
Rating	120 Volts
Amperage	7.0A
Power	800W
No Load Speed (Variable)	700~2500 RPM
Weight	7.3 lbs (3.3 kgs)
Spindle	5/8"-11
Power Supply	Single-phase AC, 50/60Hz
Plug Type	A (120V)
Cord	15ft (4.5m)
Polishing Disc Size	4" (100mm)

PART NO.	TYPE	DESCRIPTION
VSP-320	120V	Variable Speed Wet Polisher



* Also available in 230V (VSP-340)

ITEM	QUANTITY
Ground Fault Circuit Interrupter*	1
Flexible Hose w/ Garden Hose Adapter*	1
Wrench	1
C-Handle w/ Mounting Screws*	1
Side Handle (Reversible)	1
Extra Carbon Brush Set	1
Ventilation Cap w/ Rubber Band*	1
Splash Guard w/ Clamp	1
EasyOn-EasyOff Sleeve*	1

*Factory Attached



TILE BULLNOSE KIT

CREATES A FACTORY FINISH EASILY



- Designed To Create A Bullnose Edge On Tile or Stone and Polish It To A Factory Quality Finish
- Goof-Proof Hand-Held Application
- Quality Finish Without The Factory
- Save Time and Money
- Has Everything You Need Including An Instructional DVD
- Kit Contains: VSP-320 Polisher, Profiler B, 4" Ceramica EX Polishing Discs, 4" Flexible Backer Pad, Apron and DVD - 170016
- One Year Tool Warranty (See manual for details)



PROFILING



POLISHING



BULLNOSE EDGES

KIT INCLUDES:
 VSP-320, PFB101, GP45/8PD, EX40200R,
 EX40500R, EX41000R, EX42000R,
 EX43000R, APRON2000 and DVD-170016

PART NO.	DESCRIPTION
5480-1400	Tile Bullnose Kit (VSP-320)

WDP-320

WET/DRY VARIABLE SPEED POLISHER



- Variable Speed Range of 700 - 2,500 RPM
- Wet/Dry Hybrid Polisher with The Ecoguard G Attached for Tile Edge Polishing Without The Typical Mess
- Heavy-Duty Gear System Includes A Step-Down Transmission
- 15ft. Water Hose Is All-Weather Flexible & Kink-Free
- Includes Side Handle for Edge Applications
- Fits 5" Discs
- Polish or Grind Right Up To The Wall
- 15ft. Electrical Power Cord Has An Inline GFCI
- Combine with HEPA Vacuum for A Virtually Dust-Free Solution
- One Year Warranty (*See manual for details*)

ITEM	QUANTITY
Ground Fault Circuit Interrupter*	1
Water Hose Assembly*	1
Water Spray Value Assembly	1
Stainless Steel Hose Band	1
Rubber Band	1
Open End Wrench	1
Pin Wrench	1
C-Handle*	1
Side Handle (reversible)	1
Extra Carbon Brush Set	1
Rubber Hose Adapter	1
Ventilation Cap*	1
Ecoguard G*	1
Flange & Lock Nut Set	1
EasyOn-EasyOff Sleeve*	1

*Factory Attached

SPECIFICATION	DATA
Model	WDP-320
Rating	120 Volts
Amperage	7.0A
Power	800W
No Load Speed (Variable)	700~2500 RPM
Weight	7.3 lbs (3.3 kgs)
Spindle	5/8"-11

PART NO.	TYPE	DESCRIPTION
WDP-320	120V	Wet/Dry Variable Speed Polisher



AIR-300

MINI PNEUMATIC POLISHER



- High-Performance, Pneumatic Polishing Tool with A Central Water-Feed System
- No-Load 5,800 RPMs
- Lightweight and Ergonomically Design Reduces Fatigue
- Designed To Easily Maneuver in Small Areas Like Sink Rims and Bowls
- Consumes 10 CFM and Requires 87 PSI
- Only Requires 3HP Compressor
- One Year Warranty (*See manual for details*)

SPECIFICATION	DATA
Model	AIR-300
Air Pressure	87 PSI (0.6Mpa (6 bar))
Air Consumption	10 CFM (280L/Min)
No Load Speed	5,800 RPM
Weight	1.6 lbs / .731 kgs
Air Inlet	1/4" BSPT
Water Inlet	1/4" BSPP
Spindle	5/8"-11



ITEM	QUANTITY
Air Hose 10ft (3m)	1
Water Hose 10ft (3m)	1
Faucet/Garden Hose Adapter	1
Wrench (17mm)	1
Rust Inhibitor Oil (1oz / 30cc) (Replace with: AIR-008)	1



PART NO.	MAXIMUM RPM	RECOMMENDED FOR	DESCRIPTION
AIR-300	5,800	Wet Polishing	Mini Pneumatic Polisher
AIR-008		Pneumatic Tools	Rust Inhibitor Oil 8oz (237ml)

AIR-830 / AIR-834

**HIGH-PERFORMANCE
PNEUMATIC POLISHER**



AIR-830

4,000 RPM Gear Set
for Best Quality Results

SPECIFICATION	DATA
Model	AIR-830/AIR-834
Air Pressure	85 PSI (6 Bar)
Air Consumption	15 CFM (425L/min)
Weight	2.75 lbs (1.2 kgs)
No load Speed	4,000 RPM
Air Inlet	1/4" BSPP
Water Inlet	1/8" BSPP
Spindle	5/8"-11 / M14-2

PART NO.	MAXIMUM RPM	THREADS	RECOMMENDED FOR	DESCRIPTION
AIR-830	4,000	5/8"-11	Wet Polishing, Drilling & Profiling	Pneumatic Polisher
AIR-834	4,000	M14-2	Wet Polishing, Drilling & Profiling	Pneumatic Polisher
AIR-008			Pneumatic Tools	Rust Inhibitor Oil 6.7oz (200ml)

AIR-850 / AIR-854

**HIGH-PERFORMANCE
PNEUMATIC POLISHER**



AIR-850

5,500 RPM Gear Set
for Best Productivity

SPECIFICATION	DATA
Model	AIR-850/AIR-854
Air Pressure	85 PSI (6 Bar)
Air Consumption	15 CFM (425L/min)
No load Speed	5,500 RPM
Weight	2.75 lbs (1.2 kgs)
Air Inlet	1/4" BSPP
Water Inlet	1/8" BSPP
Spindle	5/8"-11 / M14-2

PART NO.	MAXIMUM RPM	THREADS	RECOMMENDED FOR	DESCRIPTION
AIR-850	5,500	5/8"-11	Wet Polishing, Drilling & Profiling	Pneumatic Polisher
AIR-854	5,500	M14-2	Wet Polishing, Drilling & Profiling	Pneumatic Polisher
AIR-008			Pneumatic Tools	Rust Inhibitor Oil 6.7oz (200ml)

Ergonomic and lightweight for better maneuverability

AIR-830



FEATURES:

- *Newly Developed Motor Produces More Power*
- *Silicon Gear Head Cover Provides Cushion and Keeps Hands Warm*
- *New Splash Guard Allows for Better Visibility Without Being Splashed*
- *Enhanced Spindle Shaft for Easy Tool Removal (Wrench Included)*
- *One Year Warranty (See manual for details)*

AIR-850

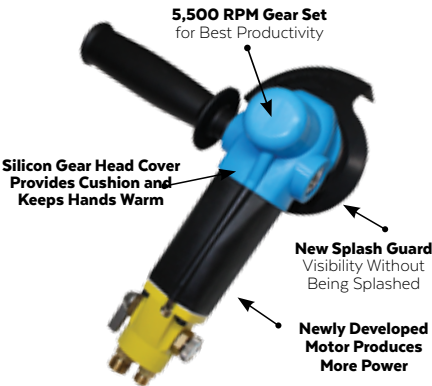

ITEMS INCLUDED:

ITEM	QUANTITY
Air Lead Hose 15ft. (4.5m)	1
Water Hose 15ft. (4.5m)	1
Side Handle (reversible)	1
Rust Inhibitor Oil (6.7oz / 200ml)	1
Screw (w/ O-Ring Seal for Oil Port)	1
Exhaust Hose with Clamp	1
Spring Washer	1
Splash Guard	1
Double End Wrench (19mm / 22mm)	1
Phillips Screwdriver	1
Water Quick Coupler w/ Shut-off Valve	1
O-Ring (O-Ring for Water Valve Repair)	1

BEVELING BASE SYSTEM

BEVELING AUXILIARY BASE

A PRECISION GRINDING AND POLISHING TOOL

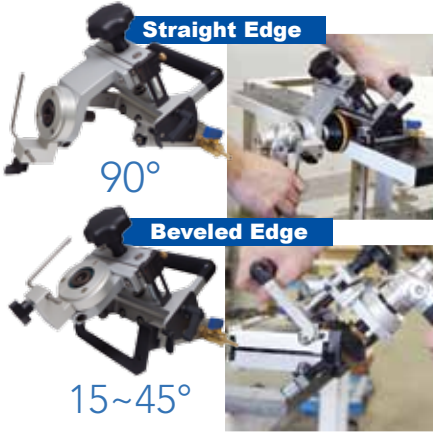

- Transforms Any Polisher or Variable Speed Grinder Into a Precision Straight and Beveled Edge Polishing Tool
- Grind and Polish from 15 degree Hollywood Bevel to 45 degree Beveled Edge or Straight Edge
- Excellent for Preparing Surfaces for Seamless Countertop Installations
- Designed to fit Polishers/Sanders/ Variable-Speed Grinders with 5/8"- 11 or M14-2 Spindle
- Grind and Polish Straight Edges with Ease
- Exterior Water-Feed System Included



SPECIFICATION	DATA
Model	BAB1590 / BAB1590-M14
Beveling Angle	15°~45°
Beveling Depth	3/8" (10mm)
Max. Straight Angle	90°
Max, Pad Size	4" (100mm)
Spindle	5/8"-11 / M14-2
Weight	3.57 lbs (1.62 kgs)

ITEM	QUANTITY
Universal Adapter Assembly	1
Clamping Base for 15°~45°	1
Screws	1
Clamping Base for 90°	1
Water Hose	1
Water Valve	1
Water Hose Assembly (10ft / 3m)	1
Hex Wrench (5mm)	1
Spanner	1

PART NO.	TYPE	RECOMMENDED FOR
BAB1590	Beveling Auxiliary Base 5/8"-11	Pneumatic/Electric Polishers
BAB1590-M14	Beveling Auxiliary Base M14-2	Pneumatic/Electric Polishers
BAB0650	Surface Protection Tape 6" x 164'	Most Surfaces



BEVELING BASE SYSTEM

BEVELING BASE STARTER KIT

CREATE A PRECISE EDGE - MITER, BEVELED OR STRAIGHT

Part number: 5480-2200
5480-2202



BEVELING BASE STARTER KIT



A Precision Grinding and Polishing Tool

INCLUDES:

Beveling Auxiliary Base
BAB1590/BAB1590-M14

Surface Protection Tape
BAB0650

Carriage Assembly for Beveling Base
BAB-CASM

Guide Rails with Clamps
4', 7', 12' (Connector & 4 Screws)
ASC-GR04 | ASC-GR07 | ASC-GR12

- Create a Precise Edge whether Mitered, Beveled or Straight
- Perfect on all Materials including Sintered Slabs and Thin Porcelain Panels
- Fabricator's Choice for Seamless Countertop Installations
- Precision Grinding for Perfect Mitered Edge for Lamination
- High-Quality Polishing Results
- Cost Savings when Compared to Expensive Machinery

PART NO.	DESCRIPTION	ARBOR
5480-2200	Beveling Base Starter Kit	5/8"-11
5480-2202	Beveling Base Starter Kit-M14	M14-2

BEVELING BASE APPLICATIONS

**POLISH
STRAIGHT AND
BEVEL EDGE
TO A FACTORY
FINISH**



**GRIND A
MITER EDGE
WITH
PRECISION**

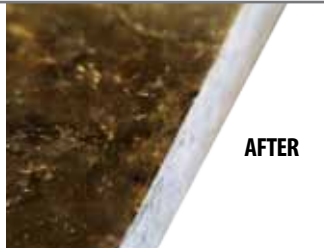

**SURFACE
PREPARATION
FOR
SEAMLESS
COUNTERTOP
INSTALLATIONS**

ACCESSORIES



Turboshine Grinding Tools

*Grind Mitered Edge with Precision
Grind Hollywood Bevel with Ease
(See page 68)*



Turboshine Polishing Tools

*Designed for Polishing Seamless Countertops and Scratch Removal for Natural and Engineered Stones
(See page 68)*



Groove Cutter

*Wet Groove Cutting Wheel for Joint Seaming
(See page 46)*

CUTTING SYSTEM OVERVIEW

KEY: ● = Highly Recommended ○ = Recommended

DRY CUTTING BLADES						
ALPHA® BLADES	SPECIALTY	BUILDING STONE FABRICATORS	TILE CONTRACTORS	MONUMENT BUILDERS	GENERAL CONTRACTORS	HARDSCAPE
BladeMaster	Demolition/Concrete Cutting				●	●
Contour for Granite / Eng. Stone	Curved Applications	●	○			○
Contour for Marble	Curved Applications	●	○			○
Contour for Porcelain	Curved Applications	●	○			●
Eclipse II	General Purpose	●	○	○	●	○
Eclipse Q	General Purpose	●	○	○	●	○
Hot-Rod	Channel Cutting	●	○	○	○	○
Katana	All Tiles	○	●	○	○	●
Laminam	Laminam by Crossville® / Porcelain Panels	○	●		○	●
Libero	Marble	●	●	○	○	○
Plus	Granite & Harder Materials	●	○	●	○	○
PT Cutter	Hardscape/Concrete Cutting	○	●		○	●
Quad	Flush Cutting	●	○	●	○	○
Rescue Blade	General Purpose	○			○	●
Trim Master	Miter Saws	●	○		○	○
Tuck Point	Tuck Pointing				○	●
Ultracut ABM	Cut-Off Tools	○	○		●	○
Ultracut APR	Flush Cutting	○	○		●	○
Ultracut GPM	Metal & Composite Materials	○	○		●	●
Vortex for Granite	Flush Cutting	●	○	●		○
Vortex for Marble	Flush Cutting	●	○	●		○
WET CUTTING BLADES						
ALPHA® BLADES	SPECIALTY	BUILDING STONE FABRICATORS	TILE CONTRACTORS	MONUMENT BUILDERS	GENERAL CONTRACTORS	HARDSCAPE
BG	Glass Blade for Cordless Saw		●		●	●
BT	Tile Blade for Cordless Saw		●		●	●
Groove Cutter	Groove Cutting	●	○	○	○	○
Ice	Granite	●	○	●	○	○
Knock Out	Granite	●				○
Marble Profile Wheel	Cut & Profile Tile	○	●		○	○
Porcellana	All Tiles	○	●		○	●
Q-Cut	Quartzite, Granite & Porcelain Paver Tiles	●	●		○	●
Silencer III	Granite	●	○	●	○	○
Silencer III	Marble	●	○	●	○	○
Silencer III	Porcelain/Crystallized Glass	●	○		○	○
Silencer III	Engineered Stone	●	○		○	○
Silencer III	Dekton®	●	○		○	○
Silencer III	Quartzite	●	○	●	○	○
Silencer VO for Dekton®	V/O Cutting on Dekton®/Porcelain/ Crystallized Glass	●				
Silencer VO for Granite/Quartz Surfaces	V/O Cutting on Granite/Quartz Surfaces	●				
Sonic	Ceramic Tile	○	○		○	○
Typhoon	Ceramic & Marble Tile	○	●		○	○
Vetro	Glass, Tile & Stone	○	●		○	●

Alpha® Dry Blades may also be used wet providing the specified RPM is maintained. However, Alpha® Wet Blades may not be used dry with exception of the Alpha® Sonic (part numbers TS04AL and TS05AL). In all cases, it is important that the application meet the defined use for that specific blade. Different sizes are available for various applications. Please refer to the specific product page or our website for additional product information.

PLUS

ULTIMATE DRY BLADE FOR STONE FABRICATORS



- Best Dry Cutting Turbo Blade on the Market
- Perfect for Granite and Engineered Stone
- 8mm Tall Diamond Layer for a Long Life
- Recommended for Hard Concrete
- Chip-Free Cutting on Most Demanding Applications

PART NO.	SIZE	THICKNESS	MAXIMUM RPM	ARBOR(S)
DA04A+	4"	2.1mm	14,500	20mm, 5/8"
DA05A+	4-1/2"	2.1mm	13,200	7/8", 20mm
DA05S	5"	2.1mm	12,200	7/8"
DA06A+	6"	2.1mm	10,100	7/8", 5/8", \diamond
DA07A+	7"	2.3mm	8,400	5/8", \diamond
DA08A+	8"	2.3mm	7,400	5/8", \diamond
DA09A+	9"	2.3mm	6,600	7/8", 5/8"
DA10A+	10"	2.5mm	5,900	1", 5/8"
DA11A+	10"	2.5mm	5,900	5/8"
DA12A+	12"	2.5mm	6,200	1", 20mm
DA13A+	12"	2.5mm	6,200	20mm

QUAD

ULTIMATE DRY FLUSH CUTTING BLADE



- Requires Quad Drive or Flange Adapter to fit High-Speed Angle Grinder
- Fits most popular High-speed Angle Grinders
- Specially Designed for Flush Cutting
- Best Dry Cutting Turbo Blade on the Market
- Chip-Free Cutting on Most Demanding Applications



PART NO.	SIZE	THICKNESS	MAXIMUM RPM	ARBOR(S)
DA04AH	4"	2.1mm	14,500	20mm Quad Drive
DA05SH	5"	2.1mm	12,200	20mm Quad Drive
DA06AH	6"	2.1mm	10,100	20mm Quad Drive
DA07AH	7"	2.3mm	8,400	20mm Quad Drive
DA08AH	8"	2.3mm	7,400	20mm Flange with 8 holes
DA09AH	9"	2.5mm	6,600	20mm Flange with 8 holes
DA11AH	10"	2.5mm	5,900	20mm Flange with 8 holes

ECLIPSE II

HIGH PERFORMANCE DRY BLADE



- High-End General Purpose Turbo Blade for Stone Fabricators
- 8mm tall Diamond Layer for a Long Life
- Perfect for your Stone Tile Application
- Consistent Performance without Chipping
- Recommended for Hard Concrete

PART NO.	SIZE	THICKNESS	MAXIMUM RPM	ARBOR(S)
DEE004	4"	2.1mm	14,500	20mm, 5/8"
DEE045	4-1/2"	2.1mm	13,200	7/8", 20mm
DEE005	5"	2.1mm	12,200	7/8"
DEE006	6"	2.1mm	10,100	7/8", 5/8", ⚡
DEE007	7"	2.3mm	8,400	5/8", ⚡
DEE008	8"	2.3mm	7,400	5/8", ⚡

ECLIPSE Q

HIGH PERFORMANCE DRY FLUSH CUTTING BLADE



- Requires Quad Drive or Flange Adapter to fit High-Speed Angle Grinder
- 8mm tall Diamond Layer for a Long Life
- Specially Designed for Flush Cutting
- High-End General Purpose Turbo Blade for Stone Fabricators
- Consistent Performance without Chipping



PART NO.	SIZE	THICKNESS	MAXIMUM RPM	ARBOR(S)	THREADS
DEQ004	4"	2.1mm	14,500	20mm Quad Drive	
DEQ005	5"	2.1mm	12,200	20mm Quad Drive	
DEQ578	5"	2.1mm	12,200	7/8" Quad Drive	
DEQ006	6"	2.1mm	10,100	20mm Quad Drive	
DEQ678	6"	2.1mm	10,100	7/8" Quad Drive	
DEQ007	7"	2.3mm	8,400	20mm Quad Drive	
DEQ008	8"	2.3mm	7,400	20mm Flange with 8 holes	
AAH-7/8		Aluminum Adapter		7/8"	5/8"-11
AAH-20		Aluminum Adapter		20mm	5/8"-11
BAH-5/8		Brass Adapter		20mm	5/8"-11

KATANA

ULTIMATE DRY BLADE FOR ALL TILES



- Tile Installer's Choice for Dry Cutting
- Specially Designed for Hard Porcelain Tile & Sintered Slabs
- Best Dry Cutting Tile Blade with Minimal Chipping
- Hybrid Dry Saw Blade for All Tiles
- Can Be used Wet or Dry

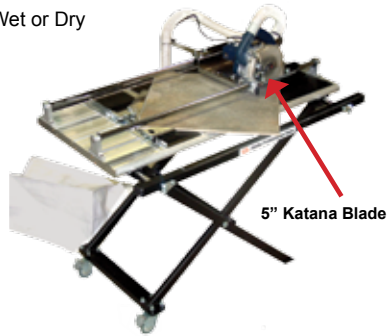

PART NO.	SIZE	THICKNESS	MAXIMUM RPM	ARBOR(S)
DPT100	4"	1.4mm	14,500	20mm, 5/8"
DPT115	4-1/2"	1.4mm	13,200	7/8", 20mm
DPT125	5"	1.4mm	12,200	7/8"
DPT150	6"	1.4mm	10,100	7/8", 5/8",



ECLIPSE II



KATANA

TUCK POINT

HIGH PERFORMANCE DRY BLADE FOR TUCK POINTING



- Virtually Dust-Free Application with Ecoguard W5 and Vacuum
- Formulated for Aggressive Cutting and Long Life
- Best Tuck Pointing Blade on the Market
- Reliable Proven Performer
- Can be used Wet or Dry

PART NO.	SIZE	THICKNESS	MAXIMUM RPM	ARBOR(S)
TP04SP	4"	6mm	14,500	7/8", 5/8"



LIBERO

ULTIMATE DRY BLADE FOR MARBLE



- Specially Designed for Marble and Limestone
- Recommended for Onyx
- Highest Quality Diamond Edge for Chip-Free Cutting
- Best Dry Cutting Electroplated Blade on the Market
- Precise Cutting Performance on Softer Stone

PART NO.	SIZE	THICKNESS	MAXIMUM RPM	ARBOR(S)
DL04A+	4"	0.8mm	14,500	20mm, 5/8"
DL05A+	4-1/2"	0.8mm	13,200	7/8", 20mm
DL05S	5"	1.0mm	12,200	7/8"
DL06A+	6"	1.2mm	10,100	7/8", 5/8", 
DL07A+	7"	1.4mm	8,400	5/8", 

TRIM MASTER

DRY BLADES FOR MITER SAWS



- 8mm tall Diamond Layer for a Long Life
- Great for Back Splash Cutting
- Perfect for Granite and Engineered Stone
- Best Dry Cutting Blade for Miter Saw
- Consistent Performance with Ease of Operation



PART NO.	SIZE	THICKNESS	MAXIMUM RPM	ARBOR(S)
TM10A+	10"	2.2mm	5,900	5/8"
TM12A+	12"	2.5mm	6,200	1", 5/8"

ULTRACUT GPM SERIES

VACUUM-BRAZED DIAMOND BLADE



- Cuts most materials without chipping or cracking
- Maintains excellent cutting performance at the maximum cutting depth
- Cuts Engineered Stone, Marble, Limestone, Angle Iron, Pipe, Electrical Conduit, Re-Bar, Metal Stud, Structural Metal, Sheet Metal, Grid, and Stainless Steel, Wood, Plastics, Composite Materials, Masonry and Concrete
- Fits on most popular hand-held electric power tools
- Available in 4-1/2", 5", 6", 7", 8" and 9"

PART NO.	SIZE	THICKNESS	MAXIMUM RPM	ARBOR(S)
GPM0420	4"	1.5mm	14,500	20mm, 5/8"
GPM4578	4-1/2"	1.5mm	13,200	7/8", 20mm
GPM0578	5"	1.5mm	12,200	7/8"
GPM06UN	6"	1.9mm	10,100	7/8", 5/8", ◀
GPM07UN	7"	1.9mm	8,400	7/8", 5/8", ◀
GPM08UN	8"	1.9mm	7,400	7/8", 5/8", ◀
GPM0978	9"	2.2mm	6,600	7/8", 5/8"

ULTRACUT APR SERIES

HYBRID BLADE FOR INTRICATE & FLUSH CUTTING



- Unique Design for Flush Cutting Applications
- Removes Anchor Bolts, Concrete Re-Bar and Pipe From Floors and Walls
- Great for Building Contractors and Fabricators Who Work with Metal and Composite Materials
- Accepts Alpha® Exclusive Quad Drive Adapter for Mounting On Angle Grinders for "Flush Cutting"
- Available in 4-1/2", 5" and 7"



PART NO.	SIZE	THICKNESS	MAXIMUM RPM	ARBOR(S)	THREADS
APR45QA	4-1/2"	1.7mm	13,200	20mm, Quad Drive	
APR05QA	5"	1.7mm	12,200	20mm, Quad Drive	
APR07QA	7"	1.9mm	8,400	20mm, Quad Drive	
BAH-5/8			Brass Adapter	20mm	5/8"-11
AAH-20			Aluminum Adapter	20mm	5/8"-11

LAMINAM®

RECOMMENDED BLADE FOR CUTTING LAMINAM



- Specially Designed for Laminam® By Crossville®
- Chip-Free Cutting On Thin Porcelain Tile/Panels
- Smooth Continuous Diamond Rim and Bond Hardness Best Suited for Glass Materials
- High-Quality Straight and True Cuts
- Excellent Choice for Plunge Cutting, Trimming Near The Edges and for Cutting An Internal Radius
- Wet/Dry Use



PART NO.	SIZE	THICKNESS	MAXIMUM RPM	ARBOR(S)
LM0438	4-3/8"	1.0mm	13,200	7/8", 20mm

SONIC

HIGH-QUALITY WET CUTTING BLADE FOR TILE



- Best Valued Wet Cutting Tile Blade
- Recommended for Ceramic and Marble Tile
- Formulated for Chip-Free Cutting and Long Life
- High-Quality, General-Purpose Tile Blade
- Wet Use Only (*Except for 4-1/2" and 5" Blades Can Be Used Wet or Dry*)

PART NO.	SIZE	THICKNESS	MAXIMUM RPM	ARBOR(S)	DEPTH
TS04AL	4"	1.4mm	14,500	20mm, 5/8"	1"
TS05AL	4-1/2"	1.4mm	13,200	7/8", 20mm	1-1/4"
TS06AL	6"	1.4mm	10,100	5/8"	1-3/4"
TS07AL	7"	1.6mm	8,400	5/8"	2-1/4"
TS08AL	8"	1.6mm	7,400	5/8"	2-3/4"
TS10AL	10"	1.6mm	5,900	5/8"	3-3/4"
TS12AL	12"	2.0mm	6,200	1"	3-5/8"
TS14AL	14"	2.0mm	4,365	1"	4-5/8"

VETRO

ULTIMATE WET BLADE FOR GLASS TILES



- Best Wet Cutting Glass Blade on the Market
- Designed for Chip-Free Cutting
- Tile Installer's Choice for Glass Tile
- Chip-Free Cutting on Most Demanding Applications
- Wet Use Only

PART NO.	SIZE	THICKNESS	MAXIMUM RPM	ARBOR(S)
WG0438	4-3/8"	1.0mm	13,200	7/8", 20mm
WG0700	7"	1.6mm	8,400	5/8"
WG0800	8"	1.6mm	7,400	5/8"
WG1000	10"	1.6mm	5,900	5/8"

VETRO for PRS

ULTIMATE GLASS BLADE FOR PORTABLE RAIL SAW



- Wet Use Only
- Designed for Chip-Free Cutting
- Tile Installer's Choice for Glass Tile
- Best Wet Cutting Glass Blade for Rail Saw on the Market
- Chip-Free Cutting on Most Demanding Applications



PART NO.	SIZE	THICKNESS	MAXIMUM RPM	ARBOR(S)
WG1001	10"	1.6mm	5,900	1", 5/8"

PORCELLANA

ULTIMATE WET BLADE FOR PORCELAIN TILES



- 3/8" (10mm) Tall Diamond Layer for Long Life
- Tile Installer's Choice for Chip Free Wet Cutting
- Recommended for Granite, Marble, Porcelain, Engineered Stone, Travertine and Ceramic Tiles
- Best Wet Cutting Tile Blade on the Market
- Hybrid Wet Saw Blade for All Tiles
- Wet Use Only

PART NO.	SIZE	THICKNESS	MAXIMUM RPM	ARBOR(S)
PT04A+	4-3/8"	1.4mm	13,200	7/8", 20mm
PT05S	5"	1.4mm	12,200	7/8"
PT07A+	7"	1.6mm	8,400	5/8"
PT08A+	8"	1.6mm	7,400	5/8"
PT10A+	10"	1.6mm	5,900	5/8"

PORCELLANA for PRS

ULTIMATE BLADE FOR PORTABLE RAIL SAWS



- 3/8" (10mm) Tall Diamond Layer for Long Life
- Tile Installer's Choice for Chip-Free Wet Cutting
- Recommended for Granite, Marble, Porcelain, Engineered Stone, Travertine and Ceramic Tiles
- Best Wet Cutting Tile Blade for Rail Saw on the Market
- Hybrid Wet Saw Blade for All Tiles
- Wet Use Only



PART NO.	SIZE	THICKNESS	MAXIMUM RPM	ARBOR(S)
PT0801	8"	1.6mm	7,400	1", 7/8", 5/8"
PT1001	10"	1.6mm	5,900	1", 5/8"

Q-CUT

THE ULTIMATE WET BLADE FOR QUARTZITE/GRANITE TILE



- Formulated To Cut Hard Tiles Such As Quartzite/ Granite
- Tile Installer's Choice for Stone Tile
- Designed for Fast, Precision Chip-Free Cutting
- Perfect for 2cm Porcelain Paver Tile
- Wet Use Only (*Except for 4-1/2" and 5" Blades Can Be Used Wet or Dry*)



PART NO.	SIZE	THICKNESS	MAXIMUM RPM	ARBOR(S)
QZ4578	4-1/2"	1.6mm	13,200	7/8", 20mm
QZ0578	5"	1.6mm	12,200	7/8"
QZ0658	6"	1.4mm	10,100	7/8", 5/8", ⚡
QZ0758	7"	1.6mm	8,400	5/8"
QZ0858	8"	1.6mm	7,400	5/8"
QZ1058	10"	2.0mm	5,900	5/8"

CORDLESS SAW BLADE

WET/DRY SAW BLADE FOR CERAMIC TILE



- Can Be Used Wet or Dry
- Ideal for Switch Box Cut-Out and Trimming
- Perfect for Ceramic and Stone Tiles
- Specially Designed for Cordless Saw
- Chip-Free Wet/Dry Cutting for Tile
- Cordless Saw Blade for Tile

PART NO.	SIZE	THICKNESS	MAXIMUM RPM	ARBOR(S)
BT03AL	3-3/8"	1.2mm	1,500	15mm



CORDLESS SAW BLADE

WET/DRY SAW BLADE FOR GLASS



- Wet Use Only
- Ideal for Switch Box Cut-Out and Trimming
- Perfect for Mirror, Glass and Glass Tile
- Specially Designed for Cordless Saw
- Chip-Free Wet Cutting for Glass Tile and Sheet Glass
- Cordless Saw Blade for Glass

PART NO.	SIZE	THICKNESS	MAXIMUM RPM	ARBOR(S)
BG03AL	3-3/8"	0.9mm	1,500	15mm



FLUSH CUTTING BLADE

VORTEX

INTRICATE & FLUSH CUTTING BLADE FOR GRANITE



- Requires Quad Drive to fit High-Speed Angle Grinder
- Perfect for Granite and Engineered Stone
- Specially Designed for Flush Cutting
- Stone Fabricator's Choice
- Chip-Free Cutting on Most Demanding Applications
- Side Protection Segments Help Cutting Straight



PART NO.	SIZE	THICKNESS	MAXIMUM RPM	ARBOR(S)	THREADS
FCD40AH	4"	2.5mm	14,500	20mm Quad Drive	
FCD50AH	5"	2.5mm	12,200	20mm Quad Drive	
AAH-20		Aluminum Adapter		20mm	5/8"-11
BAH-5/8		Brass Adapter		20mm	5/8"-11

VORTEX

INTRICATE & FLUSH CUTTING BLADE FOR MARBLE



- Requires Quad Drive to fit High-Speed Angle Grinder
- Specially Designed for Marble and Lime Stone
- Specially Designed for Flush Cutting
- Stone Fabricator's Choice
- Chip-Free Cutting on Most Demanding Application



PART NO.	SIZE	THICKNESS	MAXIMUM RPM	ARBOR(S)	THREADS
FCM50AH	5"	1.6mm	12,200	20mm Quad Drive	
AAH-20		Aluminum Adapter		20mm	5/8"-11
BAH-5/8		Brass Adapter		20mm	5/8"-11

CONTOUR FOR PORCELAIN

Curve Cutting on Porcelain,
Crystallized Glass and
Sintered Slabs



- Designed Specifically for Cutting Porcelain and Sintered Slabs
- Fits On Wet/Dry Stone Cutters
- Cuts Curved Areas Cleanly, Accurately and Safely While Allowing A Wider Kerf
- Direct Sintered Diamond Segments On Steel Core Prevents Undercutting
- Can Be Used Either Wet or Dry

PART NO.	SIZE	THICKNESS	MAXIMUM RPM	ARBOR(S)	DEPTH OF CUT
CCP004	4"	4.0mm	14,500	7/8"	3/4"
CCP045	4-1/2"	4.0mm	13,200	7/8"	3/4"
CCP005	5"	4.0mm	12,200	7/8"	1-1/4"

CURVE CUTTING BLADE

CONTOUR

CURVE CUTTING BLADE FOR GRANITE AND ENG. STONE



- Specifically Developed for Cutting Granite Sinkholes
- Best Seller for Sinkhole Application
- Works Very Well On Engineered Stone, Quartzite and Harder Types of Natural Stone
- Cuts Curved Areas Cleanly, Accurately and Safely While Allowing A Wider Kerf
- Fits on Wet/Dry Stone Cutters
- Direct Sintered Diamond Segments On Steel Core Prevents Undercutting
- Fits On CNC Router with Cutting Head
- Can Be Used Either Wet or Dry

PART NO.	SIZE	THICKNESS	MAXIMUM RPM	ARBOR(S)	DEPTH OF CUT
CCB004	4"	4.0mm	14,500	7/8"	3/4"
CCB045	4-1/2"	4.0mm	13,200	7/8"	3/4"
CCB005	5"	4.0mm	12,200	7/8"	1-1/4"
CCB006	6"	4.0mm	10,100	7/8"	1-5/8"

CONTOUR

CURVE CUTTING FOR MARBLE



- Design Specifically Developed for Cutting Marble and Limestone Sinkholes
- Fits On Wet/Dry Stone Cutters
- Cuts Curved Areas Cleanly, Accurately and Safely While Allowing A Wider Kerf
- Electroplated Diamonds on Both Sides of the Steel Core
- Can Be Used Either Wet or Dry

PART NO.	SIZE	THICKNESS	MAXIMUM RPM	ARBOR(S)	DEPTH OF CUT
CCM005	5"	1.4mm	12,200	7/8"	1-1/4"

HOT-ROD

CHANNEL CUTTING BLADE FOR GRANITE



- Perfect for Channel Cutting with Wet/Dry Stone Cutters
- Great for Grout Removal with Ecocutter
- Fabricator's Choice for Rodding on Granite
- Reliable Proven Performer
- Can Be Used Wet or Dry

ROD SIZE



GROUT WIDTH



PART NO.	SIZE	THICKNESS	MAXIMUM RPM	ARBOR(S)	RECOMENDED FOR
HT03A+	3"	4.2mm	14,500	7/8", 20mm	1/8" Rod
HQ03A+	3"	5.5mm	14,500	7/8", 20mm	3/16" Rod
HR03A+	3"	7.0mm	14,500	7/8", 20mm	1/4" Rod
HW03A+	3"	11.5mm	14,500	7/8"	3/8" Threaded Rod
HS03A+*	3"	4.75mm	14,500	7/8", 20mm	1/8" Rod
HM03A+*	3"	6.5mm	14,500	7/8", 20mm	1/4" Rod
HT04A+	4"	4.2mm	14,500	7/8", 20mm	1/8" Rod
HR04A+	4"	7.0mm	14,500	7/8", 20mm	1/4" Rod

*Marble

GROOVE CUTTER

WET GROOVE CUTTING BLADE FOR JOINT SEAMING



- Designed To Cut Flawless Grooves for Joint Seaming
- Perfect for Granite and Engineered Stone
- Specially Designed for 1-1/4" (3cm) Countertop
- Creates The Strongest Joint Seams
- Consistent Performance with Ease of Operation

PART NO.	THICKNESS	MAXIMUM RPM	THREADS	RECOMMENDED FOR	FOR USE ON
GCW258	4.2mm	14,500	5/8"-11	3/4" Slab	Granite
GCW358	7.5mm	14,500	5/8"-11	1-1/4" Slab	Granite
MCW258	4.6mm	14,500	5/8"-11	3/4" Slab	Marble
GCW214	4.2mm	14,500	M14-2	3/4" Slab	Granite
GCW314	7.5mm	14,500	M14-2	1-1/4" Slab	Granite
MCW214	4.6mm	14,500	M14-2	3/4" Slab	Marble
PFBNG01	Fits Up to 4cm Profilers			Nylon Guide	
PFBNG02	Fits All Sizes of Profilers			Nylon Guide	



MARBLE PROFILE WHEEL

WET CUTTING MARBLE PROFILE WHEEL



- Cut and Profile Marble Tile in One Pass
- Fits Tub and Tile Saws
- Ideal Tool for Cutting and Profiling Tile Baseboards
- High-Quality Diamonds and Matrix Best Suited for Wet Cutting Marble and Agglomerated Marble Tile
- Save Time, Money and Reduce Waste

PART NO.	SIZE	MAXIMUM RPM	ARBOR(S)
DPM638	6"	6,000	5/8"

BLADEMASTER

HIGH-SPEED DIAMOND BLADE FOR DEMOLITION / CONCRETE



- High-Quality Laser-Welded Segmented Blades for High-Speed Demolition Saws
- Slices Through Materials with Ease
- Works On Concrete with Re-Bar, Steel, Stone, Metal, Wood, Glass and Rubberized Materials
- Fits Masonry Saws & Road Cutters
- Can Be Used Wet or Dry
- Available in 12", 14" and 16" Diameters with Pin Hole

PART NO.	SIZE	THICKNESS	MAXIMUM RPM	ARBOR(S)
BML1214	12"	2.9mm	6,200	1" w/pin hole
BML1414	14"	3.0mm	5,360	1" w/pin hole
BML1614	16"	3.1mm	4,700	1" w/pin hole

RESCUE

DEMOLITION BLADE CUTS IT ALL



- Slices Through Materials with Ease
- Works on Concrete with Re-Bar, Steel, Stone, Metal, Wood, Glass and Rubberized Materials
- Proven Winner for Firefighters, Police Officers and Construction Professionals
- Use on Gas-Powered Cut-Off Saws
- Available in 9", 12" and 14" Diameters

PART NO.	SIZE	THICKNESS	MAXIMUM RPM	ARBOR(S)
RB09A+	9"	2.8mm	8,300	7/8"
RB12A+	12"	3.0mm	6,200	1", 7/8", 20mm w/Pin Hole
RB14A+	14"	3.2mm	5,360	1", 7/8", 20mm w/Pin Hole
DR14A+	14"	3.4mm	5,360	1", 7/8", 20mm



BLADE ACCESSORIES

QUAD ADAPTERS



- Designed for Flush Cutting Blades with Four Mounting Holes
- Made Of Durable High-Quality Brass or Aluminum
- Easily Mounted To Any Quad Drive Blade
- Available in Various Thread Sizes

PART NO.	TYPE	ARBOR(S)	THREADS
AAH-7/8	Aluminum	7/8"	5/8"-11
AAH-20	Aluminum	20mm	5/8"-11
BAH-5/8	Brass	20mm	5/8"-11

FLANGE ADAPTERS



- Designed for Blades That Are Eight Inches or Larger with Eight Mounting Holes
- Made Of Durable High-Quality Steel
- Easily Mounted To Any Large Flush Cutting Blade
- Available in 5/8"-11 and M14-2 Thread Sizes

PART NO.	TYPE	THREADS
FAH-5/8	Adapter	5/8"-11
FAH-M14	Adapter	M14-2

SPIKE RULER



- Designed As A Precision Ruler That Will Not Move On Thin Porcelain Tiles or Panels with Texturized Surfaces
- Secures Ruler To The Material
- Convenient and Easy To Use
- Made Of Aluminum with A Wood Base

PART NO.	SIZE
SPR100	3'4" (1m)

DRESSING STICK



- Designed To Expose New Cutting Surfaces or Re-Open Glazed Diamond Blades and Grinding Wheels
- Removes Sinter Bond From Cutting Edge
- Can Be Used To Ease Sharp Corners
- Bond Type: Silicon Carbide

PART NO.	SIZE	GRIT
290006	8" x 1.5" x 1.5"	60

GUIDE RAILS

CREATES STRAIGHT CUTS EVERYTIME



- Guide Rails are High-Quality Straight Edges Constructed of Sturdy Cast Aluminum
- Perform Cuts That Are Straight and True, Time After Time
- Available in Three (3) Lengths and May Be Purchased Individually or As A Kit
- Works Great When Used with A Carriage Assembly
- Must-Have Accessory for Wet/Dry Stone Cutters and Beveling Auxiliary Base
- Complete System Makes Precision Cutting Fast and Easy
- Perfect for Miter Cutting for Laminated Waterfall Edge

PART NO.	SIZE	FOR USE WITH	DESCRIPTION
ASC-GR04	4' (1.2m)		Guide Rail with 2 Clamps
ASC-GR07	7' (2.1m)		Guide Rail with 2 Clamps
ASC-GR012	12' (3.6m)		Guide Rail (2-6' pcs) with 2 Clamps, Connector & 4 Screws
ASC-GRKIT	Set		Guide Rail Bundle (3 Rails (4', 7', 12'), 6 Clamps, Connector & 4 Screws)
GR-AGCT	12" (0.3m)		Guide Rail Connector w/4 Screws (M8x20) for 12' Rails
ECO-CAM		ECC-125	Ecocutter Carriage Assembly
ASC-5CSM	5"	ESC-125	Guide Rail Carriage Assembly
ASC-6CSM	6"	PSC-150	Guide Rail Carriage Assembly
BAB-CASM		BAB1590	Carriage Assembly for Beveling Base

ASC-6CSM

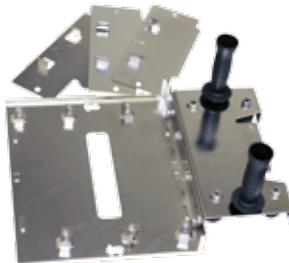

ASC-5CSM



BAB-CASM



CUTTING ACCESSORIES

EZ THIN TILE CUTTERS

FAST AND ACCURATE CUTTING TOOLS

EZ SLIMLINE OIL CUTTER



HIGH-PRECISION CUTTER

- Tungsten-Carbide wheel on a Tungsten-Carbide axle provides the cleanest score and a long, wobble-free life
- Shaped and tapered clear plastic handle with profiled grip is ideal for tile contractors, artists, and craftsmen

Part No. KOC305B



EZ THIN PANEL T-CUTTER

SMOOTH EASY CUTS



- The smooth-running, fast-cutting, easy-to-use manual glass cutter for sheet glass or thin panel materials
- Highly adaptable and quickly adjusts for odd-sized pieces as well as low maintenance and long service life
 - Makes perfect parallel cut to the guide edge with little effort



Available in 24" and 60"

Part No. KEC-600
Part No. KEC-1500

EZ GLASS RUNNING PLIERS



CLEAN BREAKS EVERYTIME

- Lightweight aluminum plier can be used on various thicknesses of glass from 5mm to 12mm
- Off-set handle provides clean and quick breaks
- The high-density plastic jaws will not chip or mark your glass



Part No. KOC512P



Unique Oil-Feed System Controls Oil Flow To Suit The Individual Needs



PART NO.	RECOMMENDED FOR	DESCRIPTION
KEC-600	Up to 24"	EZ Thin Panel T-Cutter 24"
KEC-1500	Up to 60"	EZ Thin Panel T-Cutter 60"
KOC305B	Straight Cuts	EZ Slimline Oil Cutter
KOC512P	Thickness 5mm to 12mm	EZ Glass Running Plier
5480-1700		EZ Thin Cutter Starter Kit (inc. 24" T-Cutter, Slimline Oil Cutter, Plier & Oil)
KOC1000	EZ Tile Cutter Lubricant	EZ Cutter Oil - 8oz. (237ml)

PROFILER B-SERIES

CREATES PERFECT DEMI-BULLNOSE EDGE

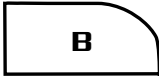

Demi-Bullnose

- Use On Granite, Engineered Stone, Marble, Concrete, Crystallized Glass, Porcelain Slabs and Sintered Slabs
- Create A Perfect Demi-Bullnose/Roundover Edge Treatment
- Nylon Guide and Rotary Touchier Assures The Proper Depth Of Cut Is Achieved
- Equipped with A 5/8"-11 Female Thread and Internal Water Passage Holes
- Fits On All Popular Water-Fed Polishers

PART NO.	SIZE	MAXIMUM RPM	THREADS	SHAPE
PFB051	3/16" (0.5cm)	3,500	5/8"-11	Demi-Bullnose
PFB101	3/8" (1.0cm)	3,500	5/8"-11	Demi-Bullnose
PFB131	1/2" (1.3cm)	3,500	5/8"-11	Demi-Bullnose
PFB201	3/4" (2.0cm)	3,500	5/8"-11	Demi-Bullnose
PFBNG01	Fits up to 4cm Profilers		Nylon Guide	
PFBNG02	Fits All Sizes of Profilers		Nylon Guide	

PROFILER F-SERIES

CREATE AN OGEE BEVELED EDGE



Breaker - Position 0



Ogee - Position 1

- Create A Perfect Ogee Edge Treatment
- Unique Two-Step Process To Make Your Operation Easier
- Works Great On Granite, Engineered Stone, Concrete, Marble and Porcelain Slab
- Fits On All Popular Water-Fed Polishers
- Nylon Guide and Rotary Touchier Assures The Proper Depth of Cut Is Achieved
- Equipped with A 5/8"-11 Female Thread and Internal Water Passage Holes

PART NO.	SIZE	MAXIMUM RPM	THREADS	SHAPE
PFF200	3/4" (2cm)	3,500	5/8"-11	Breaker-Position 0
PFF201	3/4" (2cm)	3,500	5/8"-11	Ogee-Position 1
PFF300	1-1/4" (3cm)	3,500	5/8"-11	Breaker-Position 0
PFF301	1-1/4" (3cm)	3,500	5/8"-11	Ogee-Position 1
PFBNG01	Fits up to 4cm Profilers		Nylon Guide	
PFBNG02	Fits All Sizes of Profilers		Nylon Guide	

PROFILER V-SERIES

CREATES PERFECT BULLNOSE EDGE

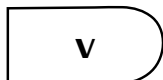

Full Bullnose

- Create A Perfect Bullnose/Roundover Edge Treatment
- Use On Granite, Engineered Stone, Marble, Limestone, Concrete, Crystallized Glass, Porcelain and Sintered Slabs
- Eliminate The Time-Consuming Calibration Process for Seamed Pieces
- Nylon Guide and Rotary Touchier Assures The Edges Are Uniform
- Equipped with A 5/8"-11 Female Thread and Internal Water Passage Holes
- Fits On All Popular Water-Fed Polishers

PART NO.	SIZE	MAXIMUM RPM	THREADS	SHAPE
PFV201	3/4" (2cm)	3,500	5/8"-11	Full Bullnose
PFV301	1-1/4" (3cm)	3,500	5/8"-11	Full Bullnose
PFV401	1-1/2" (4cm)	3,500	5/8"-11	Full Bullnose
PFV501	2" (5cm)	5,000	5/8"-11	Full Bullnose
PFV601	2-3/8" (6cm)	5,000	5/8"-11	Full Bullnose
PFBNG01	Fits Up To 4cm Profilers		Nylon Guide	
PFBNG02	Fits All Sizes of Profilers		Nylon Guide	

PROFILER Z-SERIES

PERFECT 90-DEGREE EDGE GRINDING

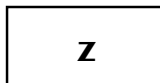

Straight Edge

- Vertical Grinding On All Types Of Materials
- Never Loses Shape for True Zero Tolerance
- Nylon Guide and Rotary Touchier Assures Uniformity
- Equipped with A 5/8"-11 Female Thread and Internal Water Passage Holes
- Fits On All Popular Water-Fed Polishers

PART NO.	SIZE	MAXIMUM RPM	THREADS	SHAPE
PFZ301	1-1/4" (3cm)	3,500	5/8"-11	Straight
PFZ401	1-1/2" (4cm)	3,500	5/8"-11	Straight
PFBNG01	Fits up to 4cm Profilers		Nylon Guide	
PFBNG02	Fits All Sizes of Profilers		Nylon Guide	

SPIKE DISC

COATING REMOVAL MADE EASY



- Designed for Thick Coating Removal of Epoxy, Urethane, Glue and Adhesives
- Unique Open-Mesh Layout Reduces Clogging and Heat Build-Up
- Optimized Diamond Grits Provide A Consistent Performance
- Sandwiched-Rubber Cushioned Light-Weight Body Reduces Noise and Vibration
- Each Diamond Bead Has Multiple Diamond Grits To Maintain A Sharp Cutting Capability for A Long Time
- Can Be Used On Wood, Glass Fiber Reinforced Polymer and Carbon Fiber Reinforced Polymer.
- Available in 4-1/2", 5" and 7" with 7/8" Arbor or with 5/8"-11 Zinc Hub and A Square Arbor for Spring Load Systems
- Combine with The Ecoguard G for A Virtually Dust-Free Solution

PART NO.	SIZE	MAXIMUM RPM	ARBOR(S)	GRIT
VCS4535	4-1/2"	13,200	7/8"	35
VCS453H	4-1/2"	13,200	5/8"-11	35
VCS4550	4-1/2"	13,200	7/8"	50
VCS455H	4-1/2"	13,200	5/8"-11	50
VCS5035	5"	13,200	7/8"	35
VCS503H	5"	12,200	5/8"-11	35
VCS503Q	5"	12,200	Sq Arbor	35
VCS5050	5"	12,200	7/8"	50
VCS505H	5"	12,200	5/8"-11	50
VCS7035	7"	8,400	7/8"	35
VCS703H	7"	8,400	5/8"-11	35
VCS7050	7"	8,400	7/8"	50
VCS705H	7"	8,400	5/8"-11	50



close-up of diamonds



sandwich construction

VEXTRA FLAT DISC

GENERAL PURPOSE FLAT GRINDING DISC



- Can Be Used On Natural Stones, Engineered Stone/ Quartz Surface, Wood and Rubber
- Optimized Diamond Grits for Consistent Performance
- Sandwich Construction Reduces Noise and Vibration
- Available in 4-1/2", 5" and 7" with 7/8" Arbor or with 5/8"-11 Zinc Hub
- Works Well When Eliminating Epoxy, Glues and Adhesives

PART NO.	SIZE	MAXIMUM RPM	ARBOR(S)	GRIT
VDD4535	4-1/2"	13,200	7/8"	35
VDD453H	4-1/2"	13,200	5/8"-11	35
VDD4550	4-1/2"	13,200	7/8"	50
VDD455H	4-1/2"	13,200	5/8"-11	50
VDD4580	4-1/2"	13,200	7/8"	80
VDD458H	4-1/2"	13,200	5/8"-11	80
VDD5035	5"	12,200	7/8"	35
VDD503H	5"	12,200	5/8"-11	35
VDD5050	5"	12,200	7/8"	50
VDD505H	5"	12,200	5/8"-11	50
VDD5080	5"	12,200	7/8"	80
VDD508H	5"	12,200	5/8"-11	80
VDD7035	7"	8,400	7/8"	35
VDD703H	7"	8,400	5/8"-11	35
VDD7050	7"	8,400	7/8"	50
VDD705H	7"	8,400	5/8"-11	50
VDD7080	7"	8,400	7/8"	80
VDD708H	7"	8,400	5/8"-11	80



sandwich construction

open-mesh

VEXCEL RIGID DISC

GENERAL PURPOSE RIGID GRINDING DISC



- Designed for Heavy-Duty Material Removal Applications
- Robust Diamond Grits for Maximum Performance
- Fluoric Rubber Backing To Reduce Noise and Vibration
- Very Aggressive and A Long Life
- Use on Granite, Engineered Stone, Quartzite, Marble, Concrete and Sintered Slabs

PART NO.	SIZE	MAXIMUM RPM	ARBOR(S)	GRIT
VDR4525	4-1/2"	13,200	7/8"	25
VDR452H	4-1/2"	13,200	5/8"-11	25
VDR4535	4-1/2"	13,200	7/8"	35
VDR453H	4-1/2"	13,200	5/8"-11	35
VDR4550	4-1/2"	13,200	7/8"	50
VDR455H	4-1/2"	13,200	5/8"-11	50
VDR4580	4-1/2"	13,200	7/8"	80
VDR458H	4-1/2"	13,200	5/8"-11	80
VDR5025	5"	12,200	7/8"	25
VDR502H	5"	12,200	5/8"-11	25
VDR5035	5"	12,200	7/8"	35
VDR503H	5"	12,200	5/8"-11	35
VDR5050	5"	12,200	7/8"	50
VDR505H	5"	12,200	5/8"-11	50
VDR5080	5"	12,200	7/8"	80
VDR508H	5"	12,200	5/8"-11	80
VDR7025	7"	8,400	7/8"	25
VDR702H	7"	8,400	5/8"-11	25
VDR7035	7"	8,400	7/8"	35
VDR703H	7"	8,400	5/8"-11	35
VDR7050	7"	8,400	7/8"	50
VDR705H	7"	8,400	5/8"-11	50
VDR7080	7"	8,400	7/8"	80
VDR708H	7"	8,400	5/8"-11	80



sandwich construction

open-mesh

DW STYLE

DESIGNED FOR NATURAL & ENGINEERED STONE



- Aggressive Grinding Wheel Specially Formulated for Natural Stone Products
- Performs Exceptionally Well On Most Granites and Harder Materials
- Turbo Design Provides Fast Stock Removal
- Premium Choice for Any Grinding, Shaping or Beveling Work
- Fabricators Love Its Aggressiveness and Endurance
- Available in 4" and 6" Diameters
- Coarse and Medium Grits Available
- Can Be Used Wet or Dry

PART NO.	SIZE	MAXIMUM RPM	THREADS	GRIT
DW4C11	4"	14,500	5/8"-11	Coarse
DW4M11	4"	14,500	5/8"-11	Medium
DW6C11	6"	10,100	5/8"-11	Coarse
DW6M11	6"	10,100	5/8"-11	Medium

DS STYLE

DESIGNED FOR NATURAL & ENGINEERED STONE



- Perfect for Lightweight Grinding and Shaping Work
- Works Well On Marbles, Granites and Engineered Stones
- Exclusive "No Bounce" Construction Reduces Operator Fatigue and Improves Control
- Fits On Most Common Angle Grinders and Wet Polishers
- Can Be Used Wet or Dry At Low or High-Speeds
- Versatile and Long Lasting
- Great for Shaping Delicate Edges

PART NO.	SIZE	MAXIMUM RPM	THREADS	GRIT
DS4C11	4"	14,500	5/8"-11	Coarse

VFLEX SANDING DISC

GENERAL PURPOSE FLEXIBLE SANDING DISC



- Perfect for paint, coating, oxide and rust removal, grinding burr and chamfering on the edge of steel, stainless steel and contoured surfaces
- For use on: Stone, Ceramic & Composite Materials
- Flexible Sandwich Construction Reduces Noise and Vibration
- Ideal for Shaping Natural/Engineered Stone and Glass
- Available in 5" and 7" with 7/8" arbor or with 5/8"-11 zinc hub

PART NO.	SIZE	MAX RPM	ARBOR(S)	GRIT
VDF5035	5"	5,000	7/8"	35
VDF503H	5"	5,000	5/8"-11	35
VDF5050	5"	5,000	7/8"	50
VDF505H	5"	5,000	5/8"-11	50
VDF5080	5"	5,000	7/8"	80
VDF508H	5"	5,000	5/8"-11	80
VDF7035	7"	5,000	7/8"	35
VDF703H	7"	5,000	5/8"-11	35
VDF7050	7"	5,000	7/8"	50
VDF705H	7"	5,000	5/8"-11	50
VDF7080	7"	5,000	7/8"	80
VDF708H	7"	5,000	5/8"-11	80



flexible sandwich construction

SANDPAPER

CONCRETE AND MARBLE POLISHING



- Waterproof Hook and Loop Backed Silicon Carbide Abrasive
- Use On Marbles and Softer Types of Natural Stone
- Can Also Be Used To Polish Glass, Metal and Wood
- Very Adaptable To Onsite Work and Easy To Use
- Resists Clogging When Used Wet
- Can Be Used Wet or Dry



HOOK AND LOOP		4"	5"
GRIT	QUANTITY	PART NO.	PART NO.
80	50	MP40080	MP50080
120	50	MP40120	MP50120
240	50	MP40240	MP50240
320	50	MP40320	MP50320
400	50	MP40400	MP50400
500	50	MP40500	MP50500
600	50	MP40600	MP50600
Assortment	50	MP40KIT	MP50KIT

CERAMICA 3-PART SYSTEM

Alpha® Ceramica is a three-part system for polishing granite, hard marble and porcelain. Utilizing the best grade industrial diamonds and the best bond materials, Alpha® Ceramica is sure to provide the best possible finish on your polished stone. Alpha® Ceramica EX augments the Ceramica line allowing the fabricator to polish a variety of different materials such as engineered stone, quartz surfaces, marble, porcelain and granite.

part 1

Ceramica Vitrified and Ceramica Metal

Long lasting and aggressive design.
Rigid or flexible depending upon application requirements.
Use for light shaping work, smoothing and preparing for the polishing process.

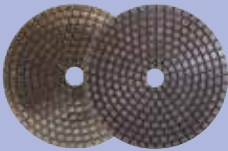
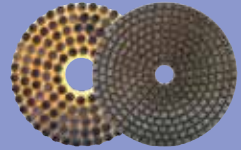

Ceramica Resin and Ceramica EX

Fine grade diamonds are heat sintered in a hard resin bond within a flexible matrix.
Each grit covers the previous grit, and through the process closes the pores for a natural polish.
After the last grit, a solid natural polish is achieved.

part 2

part 3

Ceramica Buff

Super fine abrasive disc that brings out a deep glossy reflection with a mirror finish.
Use in place of messy polishing powders and dangerous chemicals for final polishing.

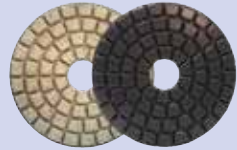

APPLICATION	VITRIFIED	RESIN	METAL
Ogee Edge	NR	R	HR
Undermount Sink Hole	NR	R	HR
Inside Corners	NR	R	HR
Bullnose	HR	R	R

(Applicable up to 300 Grit)

PERFORMANCE	VITRIFIED	RESIN	METAL
Durability	HR	R	HR
Flexibility	R	HR	HR
Cutting	HR	R	HR

POLISHING AREAS	VITRIFIED	RESIN	METAL
Concave	R	HR	HR
Convex	HR	R	R
Flat	R	NR	HR

Alpha® Ceramica is designed for a variety of applications and can be used in the polishing shop at the job site. A long time standard in the fabrication area, there are no other systems with the same capability for a deep gloss finish.

KEY: HR = Highly Recommended

R = Recommended

NR = Not Recommended

CERAMICA VITRIFIED

PREPARATION STAGE FOR WET GRANITE POLISHING



- Designed To Handle The Hard Job of Removing Saw and Grinding Marks
- Ideal for The Bullnose or Profiled Edge
- Fabricators Love The Aggressiveness, Ease of Use and Long Life
- Excellent Results On A Consistent Basis
- Available in Grits of 60, 150 and 300
- Cost-Effective Investment



HOOK AND LOOP		3"	4"	5"
GRIT	COLOR	PART NO.	PART NO.	PART NO.
60	Blue	GP30060V	GP40060V	GP50060V
150	Yellow	GP30150V	GP40150V	GP50150V
300	Orange	GP30300V	GP40300V	GP50300V

CERAMICA METAL

PREPARATION STAGE FOR WET GRANITE POLISHING



- Best Combination with Aggressive Cutting Performance and Flexibility
- Designed for Polishing Harder Types of Natural Stone
- Discs Have The Hardness of A Metal Bond Diamond in A Flexible Resin Bond Disc
- Superior Aggressiveness Compared To Standard Resin Bond Discs
- Polishes in Tight, Difficult To Reach Areas Such As Internal Corners and Inside Rim of Sink Holes
- Consistent Performance and A Long Life
- Available in Grits of 60, 150 and 300



HOOK AND LOOP		3"	4"
GRIT	COLOR	PART NO.	PART NO.
60	Blue	FD30060M	FD40060M
150	Yellow	FD30150M	FD40150M
300	Orange	FD30300M	FD40300M

CERAMICA RESIN

ULTIMATE POLISHING PADS FOR GRANITE

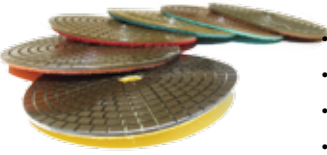

- High-Performance Discs Provide The Best Possible Polish
- Extremely Flexible with Consistent Performance
- Best in The Industry and Very Cost-Effective
- Designed for Wet Granite Hand Polishing
- Fabricators Achieve Excellent Results Consistently
- Works Extremely Well in Tight Curved Areas Such As Inside Sinkholes
- Available in 3", 4" and 5" Size Discs

HOOK AND LOOP		3"	4"	5"
GRIT	COLOR	PART NO.	PART NO.	PART NO.
150	Yellow	GP30150R	GP40150R	GP50150R
300	Orange	GP30300R	GP40300R	GP50300R
500	Red	GP30500R	GP40500R	GP50500R
1000	Dark Green	GP31000R	GP41000R	GP51000R
2000	Light Green	GP32000R	GP42000R	GP52000R
3000	Brown	GP33000R	GP43000R	GP53000R

CERAMICA EX

WET POLISHING FOR ALL STONES



- Produces A High-Quality Shine
- Polishes On All Materials
- Ideal for Polishing Inside Corners and A Tight Radius
- Works Very Well On Tough Materials Including Tough To Polish Black and Green Marbles
- Extremely Flexible



HOOK AND LOOP		3"	4"	5"
GRIT	COLOR	PART NO.	PART NO.	PART NO.
200	Yellow	EX30200R	EX40200R	EX50200R
500	Red	EX30500R	EX40500R	EX50500R
1000	Dark Green	EX31000R	EX41000R	EX51000R
2000	Light Green	EX32000R	EX42000R	EX52000R
3000	Brown	EX33000R	EX43000R	EX53000R
ALL	Assortment (1 each)	—	EX40KIT	—

CERAMICA BUFF

ULTIMATE WET GRANITE FINAL POLISHING

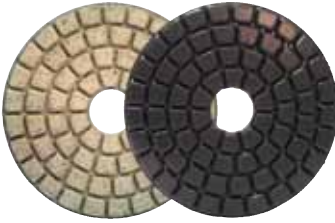

- Produces A Superior Glossy Finish
- Available in Black for Dark Stones and White for Light Colored Stones
- Small Amount of Water Required
- Consistent Performer for Professional Quality
- Hook & Loop Backed
- Use On Popular Hand-Held Wet Polishers
- Available in 3", 4" and 5"
- Favorite of Fabricators, Monumentalists and Tile Contractors

HOOK AND LOOP		3"	4"	5"
GRIT	COLOR	PART NO.	PART NO.	PART NO.
BUFF	Black	GP3BLACK	GP4BLACK	GP5BLACK
BUFF	White	GP3WHITE	GP4WHITE	GP5WHITE

CERAMICA TF

FOR TEXTURED FINISH



- Create Textured Finishes On Engineered Stone/ Quartz Surfaces
- Extremely Flexible Disc Reaches Tight Corners Comfortably
- Hook & Loop Backed for Quick Grit Changes
- Use On Popular Hand-Held Wet Polishers
- Use with Undersized Backer Pads for Internal Corners and Sink Rims



PART NO.	SIZE	TYPE	GRIT	COLOR
TFR4000	4"	Hook & Loop	Pos. 0	Orange
TFR4001	4"	Hook & Loop	Pos. 1	Red
TFR4002	4"	Hook & Loop	Pos. 2	Dark Green
TFR4003	4"	Hook & Loop	Pos. 3	Light Green
TF40KIT	4"	Hook & Loop	1 each	Assortment

KIRARA PADS

EASY THREE-STEP MAINTENANCE SYSTEM

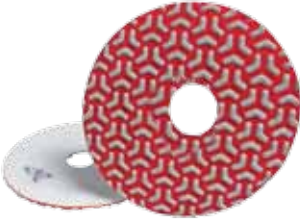

- Restore The Polish Of Marble, Limestone & Concrete Surfaces
- Great For Difficult To Polish Marble and Limestone, Such As Nero Maquina (Black Marble)
- Fast, Consistent, High-Quality Results
- Easy 3-Step Maintenance System
- Minimal Water Needed When Used Wet
- Can Be Used On A Typical Floor Buffers with 175 RPM or 300 RPM

PART NO.	SIZE	MAX RPM	TYPE	RECOMMENDED FOR	GRIT	COLOR
KWD4001	4"	4,000	Hook & Loop	Marble/Limestone/Concrete	Pos 1	Red
KWD4002	4"	4,000	Hook & Loop	Marble/Limestone/Concrete	Pos 2	Light Green
KWD4003	4"	4,000	Hook & Loop	Marble/Limestone/Concrete	Pos 3	Blue

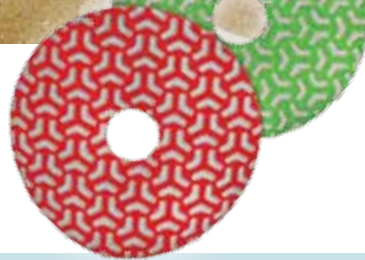
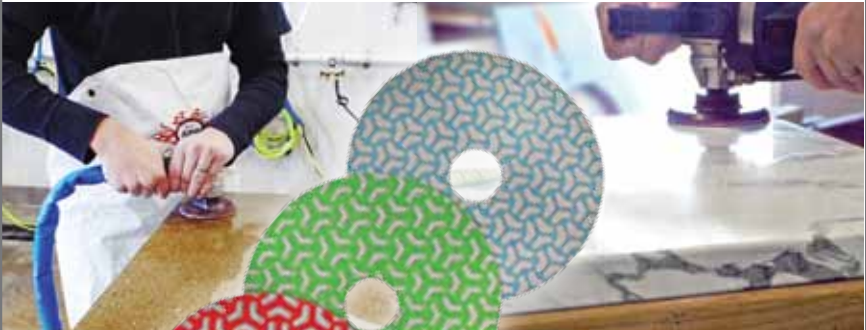

Can also be used on a **Driver Pad** for Floor Polishing!

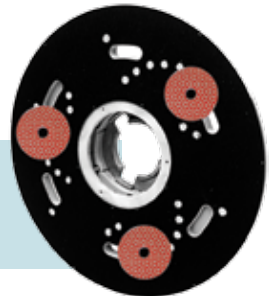

CERAMICA DRY

DRY POLISHING FOR NATURAL STONES



- Dry Polish All Natural Stones and Cement-Based Composites
- For Use On Sanders and Polishers
- Thick Diamond Layer for Better Quality Results
- Hook & Loop Backed for Quick Grit Changes
- Use On Popular Hand-Held Wet Polishers



HOOK AND LOOP		4"	5"
GRIT	COLOR	PART NO.	PART NO.
60	Blue	CD40060R	CD50060R
200	Yellow	CD40200R	CD50200R
500	Red	CD40500R	CD50500R
1000	Dark Green	CD41000R	CD51000R
2000	Light Green	CD42000R	CD52000R
3000	Brown	CD43000R	CD53000R
ALL	Assortment (1 each)	CD40KIT	CD50KIT

HAND PADS

HAND POLISHING PADS

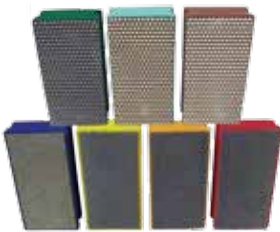

- Convenient, On-Site Polishing, On Materials
- Use On Glass, Ceramics, Marble, Granite, Porcelain, Concrete, Terrazzo and Quartz Surfaces
- Two Bond Types To Provide The Best Possible Finish
- Available in Electroplated and Resin Grits
- Can Be Used Wet or Dry



PART NO.	GRIT	COLOR	BOND TYPE
DHP0060	60	Blue	Electroplated
DHP0150	150	Yellow	Electroplated
DHP0300	300	Orange	Electroplated
DHP0500	500	Red	Electroplated
DHP1000	1000	Dark Green	Resin
DHP2000	2000	Light Green	Resin
DHP3000	3000	Brown	Resin
DHPKIT			Set of 7

PVA VP

VERSATILE, HIGH-SPEED DRY POLISHING SYSTEM



- Designed To Polish Softer Stones, Marble, Limestone, Travertine and Ceramic
- Can Be Used On Polishers, Sanders and Grinders At Any RPM
- Versatile, High-Speed and Long Lasting
- 4-1/2" Discs Do Not Clog
- Formulated with A Silicon Carbide Abrasive and A Polyvinyl Alcohol Bond
- Grits Range From Extra Coarse To Extra Fine
- Available with A 5/8"-11 Disposable Zinc Hub



VERSATILE, HIGH-SPEED DRY POLISHING SYSTEM FOR STONE & TILE

PART NO.	SIZE	GRIT	ARBOR	FINISH
SPVA45WH	4-1/2"	40	5/8"-11	Extra Coarse
SPVA45RH	4-1/2"	80	5/8"-11	Coarse
SPVA45BH	4-1/2"	220	5/8"-11	Medium
SPVA45GH	4-1/2"	400	5/8"-11	Fine
SPVA45YH	4-1/2"	600	5/8"-11	Extra Fine

PVA VP Polishing Disc with Hub



PVA MS STYLE

MARBLE EDGE POLISHING SYSTEM



- Best Polishing Solution for Glass Tile, Marble, Limestone and Travertine
- Ideal for Baseboard, Corner and Countertop Edge Applications
- Fast Working, Long Lasting At An Affordable Price
- 4" Discs Can Also Be Used for Paint Removal, As The Material Will Not Clog
- Works Well On Most Common High-Speed Grinders
- Grits Range From Extra Coarse To Extra Fine
- Available with a 5/8" Arbor
- Very Effective On Contours, Edges and Irregular Surfaces
- Polishes Stainless Steel to a mirror-like finish

PART NO.	SIZE	MAXIMUM RPM	ARBOR	GRIT	FINISH	QUANTITY
PVAMSW	4"	12,000	5/8"	40	Extra Coarse	10
PVAMSR	4"	12,000	5/8"	80	Coarse	10
PVAMSB	4"	12,000	5/8"	220	Medium	10
PVAMSG	4"	12,000	5/8"	400	Fine	10
PVAMSY	4"	12,000	5/8"	600	Extra Fine	10
PVAMSK	4"	12,000	5/8"	Assortment	All	10
SPVAMSW	4"	12,000	5/8"	40	Extra Coarse	1
SPVAMSR	4"	12,000	5/8"	80	Coarse	1
SPVAMSB	4"	12,000	5/8"	220	Medium	1
SPVAMSG	4"	12,000	5/8"	400	Fine	1
SPVAMSY	4"	12,000	5/8"	600	Extra Fine	1



10 pieces per box



ALSO AVAILABLE
IN SINGLE PACK

PVA QC STYLE

MARBLE EDGE POLISHING SYSTEM



- Best Polishing Solution for Glass Tile, Marble, Limestone and Travertine
- Ideal for Baseboard, Corner and Countertop Edge Applications
- “Quick Change” Process Saves Time, Increases Productivity
- Works Well On Most Common Low Speed Polishing Tools
- 4” Discs Can Also Be Used for Paint Removal, As The Material Will Not Clog
- Fast Working, Long Lasting At An Affordable Price
- Grits Range From Extra Coarse To Extra Fine
- Polishes Stainless Steel To A Mirror-Like Finish
- Utilizes a Snail Lock Adapter (SFAT)

PART NO.	SIZE	MAXIMUM RPM	ARBOR	GRIT	FINISH	QUANTITY
PVAQCW	4"	4,000	QC	40	Extra Coarse	5
PVAQCR	4"	4,000	QC	80	Coarse	5
PVAQCB	4"	4,000	QC	220	Medium	5
PVAQCG	4"	4,000	QC	400	Fine	5
PVAQCY	4"	4,000	QC	600	Extra Fine	5
PVAQCK	4"	4,000	QC	Assortment	All	5
SPVAQCW	4"	4,000	QC	40	Extra Coarse	1
SPVAQCR	4"	4,000	QC	80	Coarse	1
SPVAQCB	4"	4,000	QC	220	Medium	1
SPVAQCG	4"	4,000	QC	400	Fine	1
SPVAQCY	4"	4,000	QC	600	Extra Fine	1
PVA-5/8	4"	4,000	5/8"-11	Snail Lock Adapter		



5 pieces per box



ALSO AVAILABLE
IN SINGLE PACK

TURBOSHINE

POLISHING AND SCRATCH REMOVAL SYSTEM

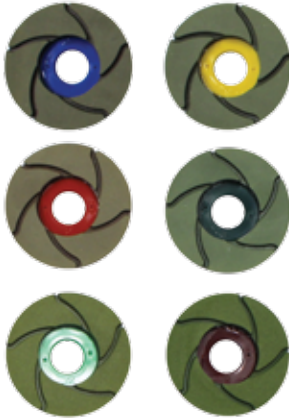

RIGID

- Designed for Polishing Seamless Countertops and Scratch Removal for Natural and Engineered Stones
- Utilizes Dual Adapter System for Reduced Vibration
- Quick Disc Type and Grit Changes Reduces Downtime
- Provides The Best Results On Granite, Engineered Stone/Quartz Surfaces, and Difficult Marbles Such As Green and Black
- Final Polishing Wheel Achieves The Highest Possible Shine
- Works Great On Concrete Slabs



BLACK BUFF

WHITE BUFF

GRINDING WHEEL

ADAPTER

PART NO.	SIZE	MAX. RPM	TYPE	THREADS	GRIT	COLOR
TSR30100R	3"	4,000	Rigid	Dual Adapter System	100	Blue
TSR30200R	3"	4,000	Rigid	Dual Adapter System	200	Yellow
TSR30500R	3"	4,000	Rigid	Dual Adapter System	500	Red
TSR31000R	3"	4,000	Rigid	Dual Adapter System	1000	Dark Green
TSR32000R	3"	4,000	Rigid	Dual Adapter System	2000	Light Green
TSR33000R	3"	4,000	Rigid	Dual Adapter System	3000	Brown
TSR3BLACK	3"	4,000	Rigid	Dual Adapter System	Buff	Black
DAS35/8PD	3"	6,000	Adapter	5/8"-11		
DAS3M14PD	3"	6,000	Adapter	M14-2		
TSM30060M	3"	14,500	Grinding Wheel	5/8"-11	60	Blue
TSM30120M	3"	14,500	Grinding Wheel	5/8"-11	120	Yellow

TURBOSHINE FOR CRYSTALLIZED GLASS

POLISHING AND SCRATCH REMOVAL SYSTEM



- Designed To Polish Straight and Beveled Edges On Crystallized Glass and Other Vitreous Materials
- Utilizes Dual Adapter System for Reduced Vibration
- Great for Polishing Seamless Countertops and Scratch Removal On Pure White Crystallized Glass and Glass2 Slabs
- Quick Grit Changes Reduces Downtime
- Final Polishing Wheel Achieves The Highest Possible Shine



PART NO.	SIZE	MAX. RPM	TYPE	THREADS	GRIT	COLOR
TSG30200R	3"	4,000	Rigid	Dual Adapter System	200	Yellow
TSG30500R	3"	4,000	Rigid	Dual Adapter System	500	Red
TSG31000R	3"	4,000	Rigid	Dual Adapter System	1000	Dark Green
TSG32000R	3"	4,000	Rigid	Dual Adapter System	2000	Light Green
TSG3TSUYA	3"	4,000	Rigid	Dual Adapter System	Tsuya Final Polish	Black
DAS35/8PD	3"	6,000	Adapter	5/8"-11		
DAS3M14PD	3"	6,000	Adapter	M14-2		
TSM30060M	3"	14,500	Grinding Wheel	5/8"-11	60	Blue
TSM30120M	3"	14,500	Grinding Wheel	5/8"-11	120	Yellow

ANTIQUE BRUSH WHEELS

BRUSH WHEELS FOR TEXTURED FINISHES



- Create A Textured Finish On The Edge and Surface Of Engineered Stone/Quartz Surfaces
- Developed with TYNEX®, A Filament From Dupont, To Ensure Safety and Exceptional Performance
- Utilizes A Snail Lock Adapter (SFAT)
- Fits Most Popular Edge Polishing Machines, Hand-Held Sanders and Polishers
- Grits Sequence of #24, #36, #60, #120, #240 and #320
- Can Be Used On Other Stone Such As Granite

SNAIL LOCK			4"	5"
GRIT	BOND TYPE	MAXIMUM RPM	PART NO.	PART NO.
24	Resin	4,000	AB4024	AB5024
36	Resin	4,000	AB4036	AB5036
60	Resin	4,000	AB4060	AB5060
120	Resin	4,000	AB4120	AB5120
240	Resin	4,000	AB4240	AB5240
320	Resin	4,000	AB4320	AB5320
Snail Lock Adapter		4,000	PVA-5/8	
Snail Lock Adapter		2,000		SFAT-5/8

FELT WHEELS

FOR USE WITH POLISHING POWDERS



- Designed for Use with Polishing Powders, Pastes or Bars
- Very Durable - Holds Up To Acidic Compounds and Heat Generated During Final Polishing
- Hook and Loop Backed Buffing Wheels
- 1/4" Thick with The Perfect Degree Of Hardness Versus Softness
- Very Popular Material for The Final Buff Process with Fabricators and Monumentalists
- Can Be Used for Floor Polishing Applications



PART NO.	SIZE	TYPE
FW30250	3"	Hook & Loop
FW40250	4"	Hook & Loop
FW50250	5"	Hook & Loop

RIGID BACKER PADS



- High-Quality Backer Pad Is Super Rigid and Flat
- Eliminates The Wavy Finish When Polishing
- Hook and Loop Backed
- The Rigidness Of The Pad Enables Work in Small Areas Such As Corners or Staircases
- Accepts Polishing Pads, Sandpaper and Felt Wheels

PART NO.	SIZE	MAX RPM	THREAD
GP35/8RG	3"	6,000	5/8"-11
GP45/8RG	4"	6,000	5/8"-11
GP55/8RG	5"	6,000	5/8"-11
GP3M14RG	3"	6,000	M14
GP4M14RG	4"	6,000	M14
GP5M14RG	5"	6,000	M14
GP3M16RG	3"	6,000	M16
GP4M16RG	4"	6,000	M16
GP5M16RG	5"	6,000	M16
RGSPACER			Spacer

FLEXIBLE BACKER PADS



- High-Quality Backer Pad Is Extremely Flexible
- Ideal for Tough Contours and Inside Curves
- Hook and Loop Backed
- Highly Resistant To The Rigors Of Daily Use Provides A Long Life
- Accepts Polishing Pads, Sandpaper and Felt Wheels

PART NO.	SIZE	MAX RPM	THREAD
GP25/8PD	2"	6,000	5/8"-11
GP35/8PD	3"	6,000	5/8"-11
GP45/8PD	4"	6,000	5/8"-11
GP55/8PD	5"	6,000	5/8"-11
GP3M14PD	3"	6,000	M14
GP4M14PD	4"	6,000	M14
GP5M14PD	5"	6,000	M14
GP3M16PD	3"	6,000	M16
GP4M16PD	4"	6,000	M16
GP5M16PD	5"	6,000	M16

GV BACKER PADS



- High-Quality Backer Pad Is Rigid and Flat, But Provides Just The Right Amount Of Flexibility
- Ideal for Bullnosed Edges and Flat Surfaces.
- Hook and Loop Backed
- Accepts Polishing Pads, Sandpaper and Felt Wheels
- Fits On Makita® GV5000 & GV5010 Sanders

PART NO.	SIZE	MAXIMUM RPM	DESCRIPTION
GV4MPPD	4"	4,500	M8-1.25 Male
GV5MPPD	5"	4,500	M8-1.25 Male

DUST COLLECTION COVERS

ECOGUARD C

HYBRID DUST COLLECTION COVER FOR CUTTING



- Designed for Collecting Dust When Using A High-Speed Angle Grinder
- Accepts Up To 5" Diameter Blades
- Can Be Used with or Without A Vacuum
- Rugged Construction for Heavy-Duty Applications
- Removes More Than 90% Of Dust
- Fits On Selected 4-1/2" - 5" High-Speed Angle Grinders
- Straight Precise Cuts Using Foot Plate
- Adjustable Cutting Depth

PART NO.	SIZE	DESCRIPTION
ECOGRDCT	5"	Dust Collection Cover C
201549		Dust Bag
500026	18"	Flexible Connector Hose (1-1/2" Tapered-2-1/4")
500073	54"	Flexible Connector Hose (1-1/2" Tapered-2-1/4")

ECOGUARD D

DUST AND DEBRIS GUARDS FOR DRILLS / HAMMER DRILLS



- Collects Dust & Debris with Ease While Using Drills/ Hammer Drills
- Convenient and Easy to Use
- Eliminates Clean-Up and Downtime on the Jobsite
- Fits Most Popular Drills and Hammer Drills
- Made for: Makita® BHR202Z, Bosch RHH180, DeWalt DCH253, Milwaukee 2605-20, Hilti TE4-A18



Optional Universal Handle



Optional Vacuum Adapter Kit



Optional Exhaust Hose

PART NO.	SIZE	RECOMMENDED FOR	DESCRIPTION
ECOGRDDL	≥ 6"	Long Drill Bits	Dust Collection Cover DL
ECOGRDDS	≤ 6"	Short Drill Bits	Dust Collection Cover DS
803172		Ecoguard D	Universal Handle for Hammer Drills
ECOVAKIT		Use With Ecoguard D	Vacuum Adapter Kit
VH91100	12ft /3.6m	3/4" Hose Diameter	Exhaust Hose 1-1/4" O.D. threaded x 2-1/4" standard

ECOGUARD CD

DUST AND WATER GUARD FOR CORE DRILLING



- Wet/Dry Cover for Drilling and Core Drilling Applications
- Fits Most Vacuum Dust Hoses
- Accepts up to 2-1/2" Core Bit
- Can Be Secured On Horizontal and Vertical Surfaces with Vacuum During Application
- Prevents Splashing When Used with Water

PART NO.	RECOMMENDED FOR	DESCRIPTION
ECOGRDCD	Core Drilling	Dust Collection Cover CD

ECOGUARD G / G7

DUST COLLECTION COVER FOR GRINDING



- Designed for Collecting Dust When Using A High-Speed Angle Grinder
- Accepts Up To 5" Diameter Grinding Wheels
- Rugged Construction for Heavy-Duty Applications
- Perfect for Grinding and Sanding Concrete or Surface Preparation Work
- Removable Cover Allows Grinding To The Edge
- Clear Cover for Better Visibility
- Easy Installation and Wheel Changes
- Fits On Selected 4-1/2" - 5" High-Speed Angle Grinders
- Must Be Used with A Vacuum

PART NO.	SIZE	DESCRIPTION
ECOGRDGR	5"	Dust Collection Cover G
ECOGRDG7	7"	Dust Collection Cover G
500026	18"	Flexible Connector Hose (1-1/2" Tapered-2-1/4")
500073	54"	Flexible Connector Hose (1-1/2" Tapered-2-1/4")
ECOGKIT	5"	Ecoguard G & 18" Connector Hose Kit
ECOG7KIT	7"	Ecoguard G7 & 18" Connector Hose Kit

ECOGUARD G7



PART#: ECOGRDG7

DUST COLLECTION COVERS

ECOGUARD W5 / W6 / W9

DUST COLLECTION COVER FOR WIDER KERF CUTTING



PART#: **ECOGRDW6**



PART#: **ECOGRDW5**

- Designed for Collecting Dust and Debris When Using A High-Speed Angle Grinder
- Perfect for Tuckpointing and Crack Chasing
- Accepts 5" Diameter Blades (W5), 6" Diameter Blades (W6), 7" and 9" Diameter Blades (W9)
- Removes More Than 90% Of Dust
- Rugged Construction for Heavy-Duty Applications
- Straight Precise Cuts Using Support Base
- Easy Installation and Blade Changes
- Fits On Selected 4-1/2", 5", 6", 7" and 9" High-Speed Angle Grinders
- Adjustable Cutting Depth - Maximum 1-1/2" (W5), 1-3/4" (W6) and 2-3/8" (W9)
- Must Be Used with A Vacuum

**Industrial
Dust
Collection
Cover**



PART#: **ECOGRDW9**



PART NO.	SIZE	DESCRIPTION
ECOGRDW5	5"	Dust Collection Cover W5
ECOGRDW6	6"	Dust Collection Cover W6
ECOGRDW9	9"	Dust Collection Cover W9
500026	18"	Flexible Connector Hose (1-1/2" Tapered-2-1/4")
500073	54"	Flexible Connector Hose (1-1/2" Tapered-2-1/4")
ECOW5KIT	5"	Ecoguard W5 & 18" Connector Hose Kit
ECOW6KIT	6"	Ecoguard W6 & 18" Connector Hose Kit
ECOW9KIT	9"	Ecoguard W9 & 18" Connector Hose Kit

WET CORE BITS

ULTIMATE WET CORE DRILLING BIT



- Designed for Drilling The Faucet-Mounting Holes in Countertops and Vanities
- Very Fast Cutting On Granite and Engineered Stone
- Make Clean Rounded Corners for Square or Rectangular Sinkholes
- Versatile and Adaptable in Many Industries for Water, Gas and Electrical Piping
- Fits On Most Popular Water-Fed Polishers

PART NO.	DIAMETER	MAXIMUM RPM	THREADS
DCB00380	3/8"	3,500	5/8"-11
DCB00500	1/2"	3,500	5/8"-11
DCB00750	3/4"	3,500	5/8"-11
DCB01000	1"	3,500	5/8"-11
DCB01250	1-1/4"	3,500	5/8"-11
DCB01375	1-3/8"	3,500	5/8"-11
DCB01500	1-1/2"	3,500	5/8"-11
DCB02000	2"	3,500	5/8"-11
DCB02500	2-1/2"	3,500	5/8"-11

DRY CORE BITS

ULTIMATE DRY CORE DRILLING BIT



- Designed for Jobsite Drilling Of Faucet-Mounting Holes in Countertops and Vanities
- Very Fast Cutting On Granite and Engineered Stone
- Convenient Dry Application
- Make Clean Rounded Corners for Square or Rectangular Sinkholes
- Versatile and Adaptable in Many Industries for Water, Gas and Electrical Piping
- Fits On Most Popular High-Speed Grinders

PART NO.	DIAMETER	MAXIMUM RPM	THREADS
DRB00500	1/2"	12,000	5/8"-11
DRB00750	3/4"	12,000	5/8"-11
DRB01000	1"	12,000	5/8"-11
DRB01250	1-1/4"	12,000	5/8"-11
DRB01375	1-3/8"	12,000	5/8"-11
DRB01500	1-1/2"	12,000	5/8"-11
DRB02000	2"	12,000	5/8"-11

VACUUM BRAZED TRIMMER BIT

DRY CUTTING OF LARGE HOLES OR CURVED LINES



- Great For Use In Construction Trades Wherever Non-Standard Shaped Cutouts Are Needed
- Perfect For Electrical Receptacles, Water-Valve Holes, Drains, Shower Knobs, Etc.
- Vacuum Brazed Technology Provides Extended Life
- Use On Granites, Engineered And Natural Stones, Porcelain And Ceramic Tiles
- Can Be Used Wet Or Dry
- Fits On A High-Speed Trimmer Tools

PART NO.	DIAMETER	MAXIMUM RPM
DTB00250	1/4"	33,000

ELECTROPLATED DRILL BITS

PREMIUM DRILL BITS FOR ANCHOR HOLES



- Designed for Drilling Holes in Tile and Stone for Pre-Installation or Post-Installation Placement
- Works Great On Marble, Granite, Engineered Stone, Ceramic, Porcelain and Glass Tile and Panels
- Can Be Used On A Standard 3/8" or Larger Drill
- Can Fit On Water-Fed Polishers with 5/8"-11 Spindles Using The Drill Bit Adapter
- Ideal for Drilling Holes for Anchors for Bathroom Fixtures, Faucet and Plumbing Pipes
- Available in 3/16", 1/4", 5/16", 3/8", 1/2", 1-3/8" and 1-1/2" Sizes
- A Must-Have for The Tile Installer's Tool Box
- Wet Use Only

PART NO.	DIAMETER	MAXIMUM RPM	TYPE
CH7205	3/16"	3,500	3/8" Shank
CH7206	1/4"	3,500	3/8" Shank
CH7208	5/16"	3,500	3/8" Shank
CH7210	3/8"	3,500	3/8" Shank
CH7212	1/2"	3,500	3/8" Shank
CH7235	1-3/8"	3,500	3/8" Shank
CH7240	1-1/2"	3,500	3/8" Shank
CH1058			Adapter 10mm to 5/8"*

(*for all polishers)

DRILL BIT GUIDE

WATER DELIVERY SYSTEM



- Prevents Wandering Drill Bits
- Delivers Sufficient Water While Providing A Secure Drilling Position
- Fits Up To 1-3/8" Diameter
- Use It with Electroplated Drill Bits
- Ideal When Drilling 1/4" Anchor Holes When Installing Towel Bars, Soap Dishes, Shelves, Cabinets and Shower Door Frames
- Suction Cup Creates A Vacuum That Secures The Guide During Application

HOW TO USE:



Soak the foam rubber on the back side with water.



Press the body to the tile and make sure it adheres properly.



Pour water up to the mark On the tank.



Slide the switch to the open position. Make sure the water drips.



Place tip of drill bit into the guide Position. Then start drilling.



Slide switch to the closed position. Pull the rubber to remove the water-feed system.



NOTE: working with mosaic tile or near grout lines use tape to secure.*

PART NO.	DESCRIPTION
WDS138	Drill Bit Guide/Water Delivery System

EZ WEDGE SYSTEM

TILE LEVELING SYSTEM FOR EDGES AND CORNERS

EZ WEDGE SYSTEM

Leveling System Designed for Edges and Corners

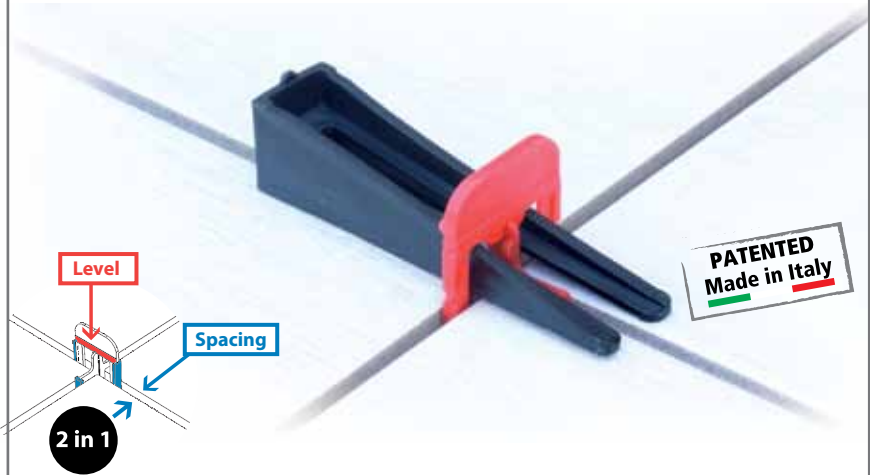

PATENTED
Made in Italy

- ✓ Install Along Tile Edges
- ✓ Add Angle Tabs to Install on Corners
- ✓ Save Time & Money Up to 75%
- ✓ Available in 1/16" (1.5mm), 1/8" (3mm) & 3/16" (5mm)
- ✓ Dual Function - No Spacers Required

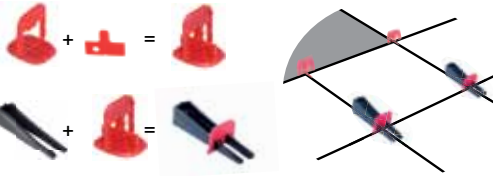
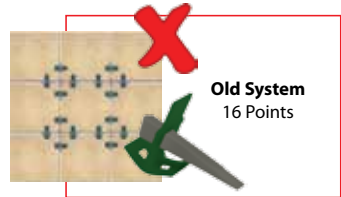
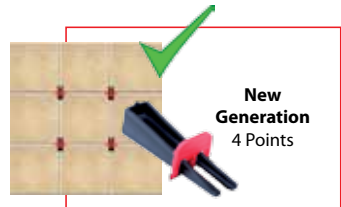

* Optional Plier Available for Calibrated installations

PART NO.	SIZE	TYPE	COLOR	QTY
EZWEDGELV		Wedge		130
EZWCT15WH	1/16" (1.5mm)	Joint Clip & Angle Tab	White	200
EZWCT30RD	1/8" (3.0mm)	Joint Clip & Angle Tab	Red	200
EZWCT50BK	3/16" (5.0mm)	Joint Clip & Angle Tab	Black	200
EZPLIER		Plier		1

EZ CLICK SYSTEM

TILE LEVELING SYSTEM FOR EDGES AND CORNERS

EZClick

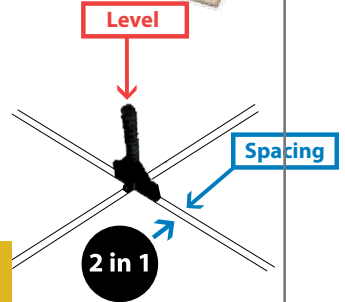
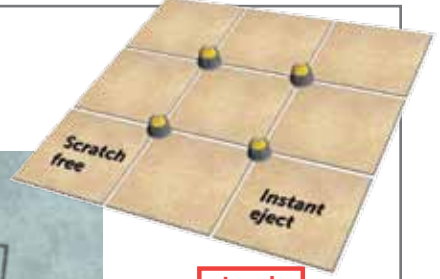

- Instant Screw Ejection Leveling System
- Supports Tile Thickness: 1/8" to 25/32" (3mm to 20mm)
- Levels and Spaces at The Same Time
- Tightens by Hand (No Tools Required)
- Minimum joint calibration: 1/32" (1mm)
- Ideal for Both Floor and Wall Tiling
- Proprietary Scratch-Prevention Edge
- Built-in spacer calibration: 3/32" (2mm), 1/8" (3mm) & 5/32" (4mm)
- Compatible With Many Older-Generation Systems
- *Patent Pending

Tightens and Releases by Hand
(No Tools Required)

The Quick and Reliable Leveling Cap

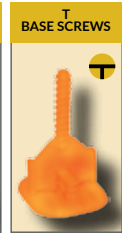
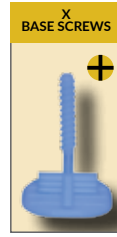
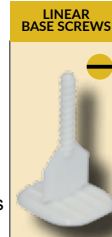

PART NO.	SIZE	TYPE	COLOR	QTY
EZCLICKCP		Screw Cap		50
EZCLB10WH	1/32" (1.0mm)	Linear Joint Screw Base	White	200
EZCLB20YW	3/32" (2.0mm)	Linear Joint Screw Base	Yellow	200
EZCLB30RD	1/8" (3.0mm)	Linear Joint Screw Base	Red	200
EZCLB40BK	5/32" (4.0mm)	Linear Joint Screw Base	Black	200
EZCXB20BL	3/32" (2.0mm)	X Joint Screw Base	Blue	200
EZCXB30VI	1/8" (3.0mm)	X Joint Screw Base	Violet	200
EZCXB40GY	5/32" (4.0mm)	X Joint Screw Base	Gray	200
EZCTB20BR	3/32" (2.0mm)	T Joint Screw Base	Brown	200
EZCTB30OR	1/8" (3.0mm)	T Joint Screw Base	Orange	200
EZCTB40GR	5/32" (4.0mm)	T Joint Screw Base	Green	200

MANIFOLD SYSTEM

FILTER REGULATOR MANIFOLD SYSTEMS



- Protects Your Tools From Contaminants
- Helps Prevent Pressure Drops When Using A Large Volume Of Air
- Adapts To The Existing Shop Piping and Increases The Life Of The Tools
- Makes It Easy To Get The Maximum Performance From Your Pneumatic Tools
- Comes in Two Sizes (53 CFM and 106 CFM)

1 Complete System for Multiple Tools

PART NO.	DESCRIPTION	ADAPTER BLOCK	CFM	PORT	PLUGS INCLUDED
1030-0021	3/8" Filter/Regulator Manifold	3/8" NPT	53	3 Couplers	(3) 1/4" Female NPT
1030-0022	3/8" Filter/Regulator Manifold	1/2" NPT	53	3 Couplers	(3) 1/4" Female NPT
1030-0023	1/2" Filter/Regulator Manifold	1/2" NPT	106	4 Couplers	(3) 1/4" Female NPT + (1) 3/8" Female NPT
1030-0024	1/2" Filter/Regulator Manifold	3/4" NPT	106	4 Couplers	(3) 1/4" Female NPT + (1) 3/8" Female NPT

2 Filter Regulator Kits for a Single Tool

PART NO.	SIZE	TYPE	THREADS	DESCRIPTION
1030-0070	53 CFM	3/8" Filter/Regulator Kit	1/2" IN-1/2" OUT	Filter/Regulator, Adapter Blocks & T-Clamps
1030-0071	53 CFM	3/8" Filter/Regulator Kit	1/2" IN-1/2" OUT	Filter/Regulator, Adapter Blocks & T-Clamps
1030-0072	53 CFM	3/8" Filter/Regulator Kit	1/2" IN-1/2" OUT	Filter/Regulator, Adapter Blocks & T-Clamps
1030-0073	106 CFM	1/2" Filter/Regulator Kit	3/4" IN-3/4" OUT	Filter/Regulator, Adapter Blocks & T-Clamps
1030-0074	106 CFM	1/2" Filter/Regulator Kit	3/4" IN-3/4" OUT	Filter/Regulator, Adapter Blocks & T-Clamps
1030-0075	106 CFM	1/2" Filter/Regulator Kit	3/4" IN-3/4" OUT	Filter/Regulator, Adapter Blocks & T-Clamps

HOSES

- All-Weather Flexibility From -40°F to +140°F
- Kink-Free Under Pressure
- Lightweight and Abrasion Resistant
- Zero Memory Allowing It To Lay-Flat
- Made Of A Premium Hybrid Polymer Material
- Comes in Many Lengths
- Pneumatic and Water Hoses Available
- Many Connectors Available



AIR HOSE

(FOR AIR-680/830/850/PSC-600)

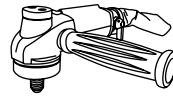

PART NO.	SIZE	DIAMETER	THREADS
1030-0002	15ft./4.5m	1/4"	1/4" NPSM x 1/4" NPT(Female Swivel)
1030-0010	20ft./6.0m	1/4"	1/4" NPSM x 1/4" NPT(Female Swivel)

Available Hose sizes: 25ft, 30ft, 35ft & 40ft. Call for Custom sizes or for more information.



WATER HOSE

(FOR AIR-680/830/850/PSC-600)

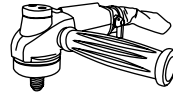

PART NO.	SIZE	DIAMETER	THREADS
1030-0003	15ft./4.5m	1/4"	1/8" NPSM x 3/4" 11GHT(GHT)
1030-0011	20ft./6.0m	1/4"	1/8" NPSM x 3/4" 11GHT(GHT)

Available Hose sizes: 25ft, 30ft, 35ft & 40ft. Call for Custom sizes or for more information.



AIR HOSE

(FOR PSC-150 & PSG-125)

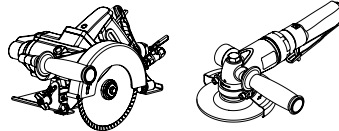

PART NO.	SIZE	DIAMETER	THREADS
1030-0031	15ft./4.5m	1/4"	3/8" NPSM x 1/4" NPT(Female Swivel)
1030-0033	20ft./6.0m	1/4"	3/8" NPSM x 1/4" NPT(Female Swivel)

Available Hose sizes: 25ft, 30ft, 35ft & 40ft. Call for Custom sizes or for more information.



WATER HOSE (FOR PSC-150)

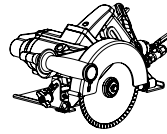

PART NO.	SIZE	DIAMETER	THREADS
1030-0032	15ft./4.5m	1/4"	1/4" NPSM x 3/4" 11GHT(GHT)
1030-0030	20ft./6.0m	1/4"	1/4" NPSM x 3/4" 11GHT(GHT)

Available Hose sizes: 25ft, 30ft, 35ft & 40ft. Call for Custom sizes or for more information.



ADAPTER HOSE (FOR MANIFOLD SYSTEMS)

PART NO.	SIZE	DIAMETER	THREADS
1030-0025	1ft./0.3m	1/2"	1/2" NPT Swivel
1030-0026	2ft./0.6m	1/2"	1/2" NPT Swivel
1030-0027	3ft./0.9m	1/2"	1/2" NPT Swivel



MOBILE HOSE (FOR MANIFOLD SYSTEMS)

PART NO.	SIZE	DIAMETER	THREADS
1030-0050	15ft./4.5m	1/2"	1/2" NPT Swivel w/Hose Protector
1030-0052	20ft./6.0m	1/2"	1/2" NPT Swivel w/Hose Protector

Available Hose sizes: 25ft, 30ft, 35ft & 40ft....Custom sizes also available. Call for more information.



EXHAUST HOSE (SPECIALTY)

*Use with ECOVAKIT

PART NO.	SIZE	DIAMETER	THREADS
VH91100	12ft./3.6m	3/4"	1-1/4" O.D. threaded x 2-1/4" standard

HEPA WET/DRY VACUUM

HEAVY DUTY VACUUM FOR ELECTRIC & PNEUMATIC TOOLS

HEAVY DUTY WORKHORSE

for all your needs!

- Triple Layer Filtering System
- Heavy Duty 15 Gal. Stainless Steel Tank
- Designed for Wet/Dry Cleanup
- 95 CFM Air Flow Rate
- 10' & 54" Crushproof Hoses Included
- 50' Power Cord



*Air Couplers Sold Separately

*Grinder not Included



PART NO.	SIZE	TYPE	DESCRIPTION
HWD2120	15-Gal	120V	HEPA Wet/Dry Vacuum
HWD2240	15-Gal	240V	HEPA Wet/Dry Vacuum



Multi-Purpose Waterproof Apron - LONG SLEEVE



Customizable Cuff
with Easy
Cut Lines for a
Perfect Fit

Wet/Dry Use



REGULAR
Part # - APRON2LSR

SMALL
Part # - APRON2LSS

APRON

MULTI-PURPOSE
APRON



- Rubber Cuffs Provides Full Coverage
- Bright Neon Yellow Color Provides Greater Visibility
- Perfect for Wet or Dry Environments
- Protects From Dust, Water and Other Chemicals
- Dual-Adjustable Clips Makes For A Perfect Fit



Dual-Adjustable Clips Makes for a Perfect Fit

PART NO.	SIZE	TYPE	DESCRIPTION
APRON2LSR	55" L X 60" W	Long Sleeve	Multi-Purpose Waterproof Apron (Regular)
APRON2LSS	42" L X 41" W	Long Sleeve	Multi-Purpose Waterproof Apron (Small)

APRON

MULTI-PURPOSE
APRON SLEEVELESS



- Sleeveless with Wide Straps for Ease and Comfort
- Bright Neon Yellow Color Provides Greater Visibility
- Perfect for Wet or Dry Environments
- Protects From Dust, Water and Other Chemicals
- Dual-Adjustable Clips Makes For A Perfect Fit



Dual-Adjustable Clips Makes for a Perfect Fit

PART NO.	SIZE	TYPE	DESCRIPTION
APRON2000	55" L X 60" W	Sleeveless	Multi-Purpose Waterproof Apron (One Size Fits All)

WET BLADE CUTTING KIT

CONVERT A HIGH-SPEED ANGLE GRINDER INTO A WET TOOL



WBC9KIT



- Can Be Used On Most Grinders With Minimal Alterations
- Fits Most 7" and 9" Angle Grinders
- Includes Kink-Free, Water-Feed Supplies, Plus GFCI



Kit includes: 9" Safety Guard, Loc-Line Assembly, Plastic Tie, 4 Plastic Collars, Adapter (1/4 NPT>>>M10*P.1.O), Water Hose Assembly, Memory Wrap (3ft. / 1M), Quick Connect Adapter, GFCI Plug (120V), Hook & Loop Tie & Screw w/Spring Lock Washer

PART NO.	SIZE	TYPE	RECOMMENDED FOR	DESCRIPTION
WBC9KIT	9"	110V	7" & 9" High-Speed Angle Grinders	Wet Blade Cutting Kit
WBC9KIT2V	9"	220V	7" & 9" High-Speed Angle Grinders	Wet Blade Cutting Kit

WET BLADE CUTTING KITS

CONVERT DRY GRINDER FOR WET CUTTING



- Designed To Convert A High-Speed Angle Grinder Into A Wet Tool
- Can Be Used On Most Grinders with Minimal Alterations
- Fits Most 4-1/2", 5" and 6" High-Speed Angle Grinders
- Kink-Free Water Hose for Easy Maneuverability and Reducing Operator Fatigue
- Save Money and Use Your Tool Wet or Dry!

Kit includes: Safety Guard, Loc-Line Assembly, Plastic Tie, Stainless Steel Collar, Plastic Collar, Adapter (1/4 NPT>>>M10*P.1.O), Water Hose Assembly, Memory Wrap (3ft. / 1M), Quick Connect Adapter, GFCI Plug (120V) & Hook & Loop Tie

PART NO.	SIZE	TYPE	RECOMMENDED FOR	DESCRIPTION
WBC5KIT	5"	110V	4-1/2", 5" & 6" High-Speed Angle Grinders	Wet Blade Cutting Kit
WBC6KIT	6"	110V	4-1/2", 5" & 6" High-Speed Angle Grinders	Wet Blade Cutting Kit
WBC5KIT2V	5"	220V	4-1/2", 5" & 6" High-Speed Angle Grinders	Wet Blade Cutting Kit
WBC6KIT2V	6"	220V	4-1/2", 5" & 6" High-Speed Angle Grinders	Wet Blade Cutting Kit

WET SANDING/ POLISHING KIT

CONVERTS DRY POLISHER / SANDER INTO A WET TOOL



- Designed To Convert A Dry Polisher Into A Wet Tool
- Save Money and Use Your Tool Wet or Dry!
- Quick Solution for OSHA Compliance
- Kit includes: Safety Guard, Loc-Line Assembly, Water Hose Assembly, Memory Wrap (3ft. / 1M), Quick Connect Adapter, GFCI Plug (120V) & Hook & Loop Strap



PART NO.	RECOMMENDED FOR	DESCRIPTION
WSPKIT	Sanders & Polishers	Wet Sanding & Polishing Kit

CORNER NIPPERS

**CUT GLASS
CORNERS EASILY**



- Designed To Chop The Corner of Sheet Glass Without Breakage
- Made with Tungsten Carbide Tips and Sharpened By A Diamond Wheel
- Ideal for Quickly Making Round Corners in Preparation for Final Edge Polishing
- Two Sizes Available: 3/4" (20mm) and 1-1/4" (30mm) Radius
- Also Works On Porcelain and Other Ceramic Tiles



PART NO.	SIZE	DESCRIPTION
CNP020	3/4" (20mm) Radius	Carbide Tip Corner Nipper
CNP030	1-1/4" (30mm) Radius	Carbide Tip Corner Nipper
CNC030	Universal	Carbide Tip Continuous Corner Nipper

CORNER RULER

UNIQUE TOOLS FOR FABRICATING CORNERS



- Mark, Cut and Grind The Square Corners of Glass, Tile, Stone, Porcelain Plastic and Wood
- Sets Comes with Either Two Radiuses or Two 45-Degree Straight Lines
- Makes for Quick and Easy Preparation Time
- Sets Come in A Stainless Steel Case for Organization



PART NO.	DESCRIPTION
CRR1075	Ruler Radius 3/8"+3"
CRR1570	Ruler Radius 5/8"+2-3/4"
CRR2065	Ruler Radius 3/4"+2-5/8"
CRR2560	Ruler Radius 1"+2-1/2"
CRR3055	Ruler Radius 1-1/4"+2-3/8"
CRR3550	Ruler Radius 1-3/8"+2"
CRR4045	Ruler Radius 1-1/2"+1-3/4"
CRRSET7	Ruler Radius Set w/Case
CRS1075	Ruler Straight 3/8"+3"
CRS1570	Ruler Straight 5/8"+2-3/4"
CRS2065	Ruler Straight 3/4"+2-5/8"
CRS2560	Ruler Straight 1"+2-1/2"
CRS3055	Ruler Straight 1-1/4"+2-3/8"
CRS3550	Ruler Straight 1-3/8"+2"
CRS4045	Ruler Straight 1-1/2"+1-3/4"
CRSET7	Ruler Straight Set w/Case
CRSET14	Ruler Combo Set

DUST CARRIAGE

DUST CONTROL CARRIAGE SYSTEM



- Designed As A Support To Hold The Dust Bag When Cutting or Grinding
- Conveniently Pulls Behind The Tool So As Not To Interfere with The Job
- Front Swivel Wheels Allows for Easy Maneuvering
- Dust Bag Is Easily Secured To The Dust Carriage with Ties
- Recommended for Flat Surfaces

PART NO.	SIZE	TYPE	DESCRIPTION
ECO-CARS	5"	110V	Dust Bag Carriage (includes Dust Bag)
801392	16" x 13-1/2" X 8"		Dust Bag

GLOSS CHECKER



- Portable Gloss Meter Designed To Measure The Reflective Index Of Light
- Enables Quick, Accurate Measurements Of Gloss On Flat, Polished Surfaces
- Ensures Quality Control and Assists Setting Standards
- Detachable Meter for Difficult To Reach Areas
- Can Be Used Across Multiple Industries

PART NO.	DESCRIPTION
IG-331	Gloss Meter

SAFETY GLASSES



- Designed for Safety and Comfort
- A Lightweight Frame with Padded Temples
- Adjustable Side Arms
- Soft Rubber Nose Bridge
- Clear Anti-Scratch Lenses
- Available in a single pair or 12-pack
- Complies with standard # BS EN 166:2001

PART NO.	DESCRIPTION
173002	Safety Glasses (Box of 12)
173008	Safety Glasses (Single Pair)

GROUND FAULT CIRCUIT INTERRUPTER



- Protect Polishing Personnel From Lethal Ground Current Loads
- Highly Recommended Piece Of Equipment
- Rated for 15 Amps

PART NO.	DESCRIPTION
GFCI-1	Ground Fault Circuit Interrupter

G-TAPE

ALL PURPOSE PROTECTION & REPAIR TAPE

MULTI-PURPOSE, HARD SURFACE PROTECTION AND REPAIR TAPE

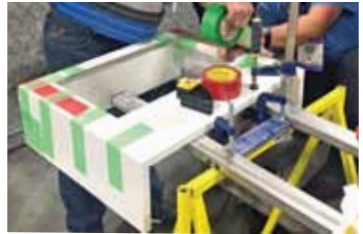

Features:

- Hand Tearing-Straight & Easy
- Residue Free Removal
- Waterproof
- All-Weather Usage (-40°F to +200°F)
- Repositionable
- Highly Weather/UV Resistant
- Good Surface Protection
- Great for Quick Repairs

PART NO.	COLOR	SIZE	RECOMMENDED FOR
GT1009GR	Green	2" x 164'	Multi-Purpose - All Surfaces
GT1008SW	White	2" x 164'	Extra UV Protection
GT1006TG	Black & Yellow	2" x 82'	Caution Areas
GT1009CL	Clear	2" x 164'	Multi-Purpose - All Surfaces
BAB0650	Black	6" x 164'	Large Surface Protection

MULTI-PURPOSE APPLICATIONS





Multi-Purpose Tape

Multi-Purpose Surface Protection and Repair Tape

- Hand Tearing-Straight and Easy
- Residue Free Removal
- Waterproof
- All-Weather Usage (-40°F to +200°F)
- Repositionable
- Highly Weather/UV Resistant
- Good Surface Protection
- Great for Quick Repairs
- Easily Mark Tape With Ball Point Pen, Permanent Marker, China Marker Etc.

PART NO.	COLOR	SIZE	RECOMMENDED FOR
GT1009GR	Green	2" x 164'	Multi-Purpose - All Surfaces
GT1009CL	Clear	2" x 164'	Multi-Purpose - All Surfaces



Extra UV Protection

Multi-Purpose Surface Protection and Repair Tape

- Hand Tearing-Straight and Easy
- Residue Free Removal
- Waterproof
- All-Weather Usage (-40°F to +200°F)
- Repositionable
- Highly Weather/UV Resistant
- Good Surface Protection
- Great for Quick Repairs

PART NO.	COLOR	SIZE	RECOMMENDED FOR
GT1008SW	White	2" x 164'	Extra UV Protection



HVAC Tape

Multi-Purpose Surface Protection and Repair Tape

- Perfect for Seaming and Splicing Tape for Insulation and HVAC
- Hand Tearing-Straight and Easy
- Residue Free Removal
- Waterproof
- All-Weather Usage (-40°F to +200°F)
- Repositionable Without Wrinkles
- Highly Weather/UV Resistant
- Safer tape as edge is not as sharp as aluminum foil
- Complies with ASTM E84 (UL723) : Class 1, Flame Spread Index 0, Smoke Developed Index 0

PART NO.	COLOR	SIZE	RECOMMENDED FOR
GT2010AL	Silver	2" x 82'	HVAC and Insulation



Caution Area Tape

Multi-Purpose Surface Protection and Repair Tape

- Hand Tearing-Straight and Easy
- Residue Free Removal
- Waterproof
- All-Weather Usage (-40°F to +200°F)
- Repositionable
- Highly Weather/UV Resistant
- Good Surface Protection
- Great for Quick Repairs

PART NO.	COLOR	SIZE	RECOMMENDED FOR
GT1006TG	Black & Yellow	2" x 82'	Caution Areas



Acrylic Flashing Tape

High Adhesion Acrylic Flashing Tape

- Perfect Flashing for Windows, Doors, & Deck Beams
- Hand Tearing-Straight and Easy
- Waterproof
- All-Weather Usage (-40°F to +200°F)
- Highly Weather/UV Resistant
- AAMA 7-11 Level 3 Class A Certified
- Great Performance and Ease of Use
- Cleanly Removes from Face-to-Face Adhesive Contact
- Available as a single roll or by the case

***Permanent Adhesion**

PART NO.	COLOR	SIZE	RECOMMENDED FOR
GT3040BK02	Black	2" x 65'	Acrylic/Flashing- All Surfaces
GT3040BK04	Black	4" x 65'	Acrylic/Flashing- All Surfaces
GT3040BK06	Black	6" x 65'	Acrylic/Flashing- All Surfaces
GT3040BK09	Black	9" x 65'	Acrylic/Flashing- All Surfaces
GT3040BK12	Black	12" x 65'	Acrylic/Flashing- All Surfaces



Surface Protection

Repositionable Waterproof Surface Protection Tape

- Protects Surfaces from Scratches, Stains and Etching
- Applicable for All Stone Faces Including Marble and Limestone
- Can Be Used for Wet and Dry applications
- Easily Mark Tape with Ball Point Pen, Permanent Marker, China Marker, etc.

PART NO.	COLOR	SIZE	RECOMMENDED FOR
BAB0650	Black	6" x 164'	Large Surface Protection

RSR-2000

**RUST STAIN REMOVER
IN GEL FORM**



- Removes Common Rust Stains From Natural Stone Surfaces, Concrete, Brick, Terra Cotta, Mexican Tile, or Other Hard Porous Surfaces
- Specially Formulated To Work Extremely Fast
- Non-Hazardous Chemical Is Safe To Use and Will Not Harm The Environment
- Use On Floors, Countertops, Vertical Surfaces and Exterior Areas
- Available in 14oz Tube or Trial Size 1.4oz Bottle
- Tube Covers Approximately 4 sqft

PART NO.	SIZE	CONTAINER
RSR-400G	14 oz. (400g)	Tube
RSR-040G	1.4 oz. (40g)	Bottle



Index

A

Adapter Hose 83
AIR-300 24
AIR-830 / AIR-834 25, 26
AIR-850 / AIR-854 25, 26
AIR Hose 82
Antique Brush Wheels 70
Apron 85, 86
AWS-110 11

B

Beveling Auxiliary Base 27
Beveling Base Starter Kit 28
Beveling Base
 Applications 29
Blademaster 47

C

Ceramica 3-Part System 59
Ceramica Buff 62
Ceramica Dry 64
Ceramica EX 61
Ceramica Metal 60
Ceramica Resin 61
Ceramica TF 62
Ceramica Vitrified 60
Contour
 Granite & Eng. Stone 44
 Marble 44
 Porcelain 43
Cordless Saw Blade
 Ceramic Tile 41
 Glass 41
Corner Nippers 89
Corner Ruler 90
Countertop Trim Kit 6

D

Diamond Face Foam Pads 20
Dressing Stick 48
Drill Bit Guide 77
Dry Core Bits 75
DS Style 56
Dust Carriage 91
DW Style 56

E

ECC-125 12, 13
ECC-KIT 13
Eclipse II 32
Eclipse Q 32
Ecoguard C 72
Ecoguard CD 73
Ecoguard D 72
Ecoguard G 73
Ecoguard W Series 74
Electroplated Drill Bits 76
ESC-125 5

Exhaust Hose 83
EZ Click System 79
EZ Thin Tile Cutters 50
EZ Wedge System 78

F

Flange Adapters 48
Felt Wheels 70
Flexible Backer Pad 71

G

Gloss Checkers 91
Groove Cutter 46
Ground Fault
 Circuit Interrupter 91
G-Tape 92-94
Guide Rails 49
GV Backer Pads 71

H

Hand Pads 64
Hepa Wet/Dry Vacuum 84
Hoses 82
Hot-Rod 45

K

Katana 33
Kirara Pads 63

L

Laminam® 37
Libero 35

M

Manifold System 80, 81
Marble Profile Wheel 46
Mobile Hose 83

P

Plus 31
Porcellana 39
 For Portable Rail Saw 39
Profilers
 B-Series 51
 F-Series 51
 V-Series 52
 Z-Series 52
PSC-150 10
PSC-150 Miter Cutting Kit 9
PSC-600 4
PSG-125 14, 15
 Diamond Cutting Kit 16
 Dust-Free Grinding Kit 16
PVA MS Style 66
PVA QC Style 67

PVA VP 65

Q

Q-Cut 40
Quad 31
Quad Adapters 48

R

Rescue 47
Rigid Backer Pad 71
Rotary Backer Pad 19
RSR-2000 95

S

Safety Glasses 91
Sandpaper 58
Sonic 37
Spike Disc 53
Spike Ruler 48

T

Tile Bullnose Kit 22
Trim Master 35
Tuck Point 34
Turboshine 68
Turboshie for Crystallized Glass 69

U

Ultracut
 APR Series 36
 GPM Series 36

V

Vacuum Brazed
 Trimmer Bit 76
VDP-700 17, 18
Vetro 38
 For Portable Rail Saw 38
Vexcel Rigid Disc 55
Vextra Flat Disc 54
Vflex Sanding Disc 57
Vortex
 For Granite 42
 For Marble 42
VSP-320 21

W

Water Hose 83
WBC9KIT 87
WDP-320 23
Wet Blade Cutting Kit 88
Wet Core Bits 75
Wet Sanding / Polishing Kit 88
Wool Pads 19

Product Literature Catalogs

Alpha® provides product catalogs for all products to best serve the particular needs of our customers. Catalogs are available for applications such as Hand Tooling and Large Machine Tooling, as well as for specific industries such as stone, tile, construction, industrial, automotive, composites, glass and marine.

All of our catalogs are a convenient portable of size 5.5" x 8.5", and illustrate the tools and accessories needed for Cutting, Profiling, Grinding, Drilling, Polishing and Restoring all types of materials.

To request these catalogs, or for more information about our product line, visit our website at www.alpha-tools.com or contact us at 800-648-7229.



ALPHA® TOOL REPAIR

- Authorized repair centers available
- All tool repairs carry a 30-day warranty
- Quick turn-around time
- Technical support for repair and maintenance
- Order replacement tool parts directly from Alpha®
- Loaner program available

Visit our website to find a local center



Let's get social...



We are ready to connect with you on your favorite social media sites... Join Us Today!

 **Alpha Professional Tools®**

103 Bauer Drive • Oakland, NJ 07436
800-648-7229 • Fax: 800-286-0114



www.alpha-tools.com