

TOOLS FOR

# TILE & STONE CONTRACTORS

CUTTING, PROFILING & POLISHING

**ALPHA®**



# 35<sup>TH</sup>

## ANNIVERSARY

Since 1986

*Celebrating 35 Years  
Providing Better Solutions to the Professional*



**VERSION 6**

# CONTACT US



---

## WELCOME

---

*Alpha Professional Tools® was founded in 1986 and has become a leading manufacturer of quality tools for professionals in the natural/engineered stone, porcelain, ceramic, glass, construction, marine and automotive industries. Alpha® provides the best products for cutting, drilling, shaping and polishing all types of materials.*

*In addition to providing the best products in the industry, Alpha Professional Tools® offers a variety of services to support their products.*

### **Company Contact Information:**

Headquarters & Training Center:	16 Park Drive Franklin, NJ 07416
Hours of Operation (EST):	8:30 a.m. - 5:00 p.m.
Telephone No:	201-337-3343
Toll-Free No:	800-648-7229
Fax No:	201-337-2216
Toll Free Fax No:	800-286-0114

### **E-mail Orders to:**

[orderdesk@alpha-tools.com](mailto:orderdesk@alpha-tools.com)  
[tooldesk@alpha-tools.com](mailto:tooldesk@alpha-tools.com)

### **Contact Us:**

[www.alpha-tools.com](http://www.alpha-tools.com)  
[info@alpha-tools.com](mailto:info@alpha-tools.com)

### **Follow Us:**



### **Sales Contacts by Territory – [sales@alpha-tools.com](mailto:sales@alpha-tools.com)**

Caribbean	201-337-3343	Ohio Valley	440-364-3759
Canada	519-546-9861	Pacific	800-648-7229
International	201-337-3343	South	480-848-6808
Midwest	630-849-7105	Southeast	678-977-1147
Northeast	973-830-7681	Southern CA	925-428-1292
Northern CA	925-428-1292		

## TOOLS

### STONE CUTTER

- ESC-125, Wet Stone Cutter .....2
- Countertop Trim Kit .....4
- PSC-150 Miter Cutting Kit .....5
- PSC-150, Pneumatic Stone Cutter .....7
- AWS-110, Wet Stone Cutter .....8
- ECC-125, Ecocutter .....9
- ECC-KIT, Dry Porcelain Paver Tile Cutting System .....10

### GRINDERS

- PSC-600, High-Performance Pneumatic Stone Cutter .....1
- PSG-658, High-Performance Pneumatic Grinder .....11
- PSG-125, Pneumatic Cutter/Grinder .....12
- PSG-125 Diamond Cutting Kit .....13
- PSG-125 Grinding Kit .....13

### POLISHERS

- VDP-700 Variable Speed Rotary Polisher .....14
  - Wool Pads .....16
  - Rotary Backer Pads .....16
  - Diamond Face Foam Pads .....17
- VSP-320, Variable Speed Wet Polisher .....18
- Tile Bullnose Kit .....19
- WDP-320, Wet/Dry Polisher .....20
- AIR-680UW, Pneumatic Polisher for Underwater Applications .....21
- AIR-830 / 850, High Performance Pneumatic Polishers .....22
- AIR-300, Mini Pneumatic Polisher .....24
- Beveling Auxiliary Base .....25
- Beveling Base Starter Kit .....26
- Beveling Base Applications .....27

## CUTTING

- Cutting System Overview .....28

### DRY BLADES

- Plus .....29
- Quad .....29
- Eclipse II .....30
- Eclipse Q .....30
- Katana .....31
- Tuckpoint .....32
- Libero .....33
- Trim Master .....33
- Ultracut GPM Series .....34
- Ultracut APR Series .....34

### WET BLADES

- Laminam .....35
- Sonic .....35
- Vetro .....36
- Vetro for PRS .....36
- Porcellana .....37
- Porcellana for PRS .....37
- Q-Cut .....38

# TABLE OF CONTENTS

- Cordless Saw Blade for Ceramic Tile .....39
- Cordless Saw Blade for Glass .....39
- Vortex for Granite .....40
- Vortex for Marble .....40
- Contour for Porcelain .....41
- Contour for Granite & Engineered Stone .....42
- Hot-Rod .....43
- Groove Cutter .....44
- Marble Profile Wheel .....44
- BladeMaster .....45
- Rescue .....45

## BLADE ACCESSORIES

- Quad Adapters .....46
- Flange Adapters .....46
- Spike Ruler .....46
- Dressing Stick .....46
- Guide Rails .....47
- EZ Thin Tile Cutters .....58

## PROFILING

- Profiler B-Series .....49
- Profiler V-Series .....50
- Profiler Z-Series .....50

## GRINDING & SANDING

### SURFACE GRINDING

- Spike Disc .....51
- Vextra Flat Disc .....52

### EDGE GRINDING

- Vexcel Rigid Disc .....53
- DW Style Grinding Wheel .....54
- DS Style Grinding Wheel .....54

### SANDING

- VFlex Sanding Disc .....55
- Sandpaper .....56

## POLISHING

### DIAMOND PADS

- Ceramic Three-Part Polishing System .....57
- Ceramica Vitrified .....58
- Ceramica Metal .....58
- Ceramica Resin .....59
- Ceramica Buff .....59
- Ceramica EX .....60
- Ceramica TF .....60
- Kirara .....61

## DRY POLISHING DISCS

- Ceramica Dry ..... 62
- Hand Pads..... 62
- PVA VP ..... 63
- PVA MS Style ..... 64
- PVA QC Style ..... 65

## POLISHING WHEELS

- Turboshine..... 66
- Turboshine for Crystallized Glass..... 67
- Antique Brush Wheels ..... 68
- Felt Wheels ..... 68

## BACKER PADS

- Rigid Backer Pads..... 69
- Flexible Backer Pads..... 69
- GV Backer Pads..... 69

## DUST COLLECTION COVERS

- Ecoguard CD..... 70
- Ecoguard G ..... 70
- Ecoguard W..... 71
- Ecoguard C ..... 72
- Ecoguard D ..... 72

## DRILLING

- Wet Core Bits ..... 73
- Dry Core Bits ..... 73
- Trimmer Bits ..... 74
- Electroplated Drill Bits ..... 74

## ACCESSORIES

- EZ Wedge System..... 75
- EZ Click System..... 76
- EZ Click2 System ..... 77
- Manifold System..... 78
- Air Hose (AIR-680 / AIR-830 / AIR-850 / PSC-600) ..... 80
- Water Hose (AIR-680 / AIR-830 / AIR-850 / PSC-600) ..... 80
- Air Hose (PSC-150 & PSG-125) ..... 80
- Water Hose (PSC-150)..... 81
- Adapter Hose ..... 81
- Mobile Hose ..... 81
- Exhaust Hose ..... 81
- Apron..... 82
- Wet Blade Cutting Kits..... 84
- Wet Sanding / Polishing Kit ..... 85
- Corner Rulers ..... 86
- Dust Carriage ..... 87
- Gloss Checker..... 87
- Safety Glasses ..... 87
- GFCI (Ground Fault Circuit Interrupter)..... 87
- G-Tape..... 88
- Stain Removers..... 93

# PNEUMATIC CUTTER

## PSC-600

## HIGH-PERFORMANCE PNEUMATIC STONE CUTTER/GRINDER

**GREAT FOR GRINDING ALSO!**



- Center Water-Feed System to Deliver Ample Water Regardless of Position
- 15ft. All-Weather Hoses with Flexibility Down To -40°F Or +140°F(-40°C To +60°C)
- Newly Developed Motor Produces More Power
- Lightweight and Ergonomically Designed for Better Maneuverability
- Composite End Case to Prevent Freezing Hands
- Silicon Gear Head Cover Provides Cushion and Keeps Hands Warm
- Enhanced Spindle Shaft for Easy Tool Removal (Wrench included)
- One Year Warranty (See manual for details)

SPECIFICATION	DATA
Model	PSC-600
Air Pressure	85 PSI (6 Bar)
Air Consumption	15 CFM (425L/min)
Weight	2.9 lbs (1.3 kgs)
No Load RPM	8,500 RPM
Air Inlet	1/4" BSPP
Water Inlet	1/8" BSPP
Arbor	7/8" (22mm)
Cutting Disc Diameter	6" (150mm)
Length	7-1/2" (190.5mm)

ITEM	QUANTITY
Air Hose (15ft / 4.5m)	1
Water Hose (15ft / 4.5m)	1
Side Handle (reversible)	1
Rust Inhibitor Oil (6.7oz/200ml)	1
Screw (w/O-Ring Seal for Oil Port)	1
Exhaust Hose & Clamp	1
Spring Washer	1
6" Safety Guard	1
Double End Wrench (19mm/22mm)	1
Phillips Screwdriver	1
Water Quick Coupler w/Shut-off Valve	1
O-Ring (O-Ring for Water Valve Repair)	1
Single Open End Wrench (22mm)	1
Hex Wrench (6mm)	1
Inner Flange for Cutting	1
Outer Flange	1
L-Bracket	1
Inner Flange for Grinding	1

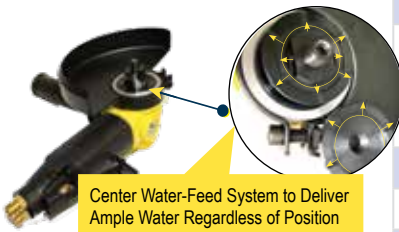

Center Water-Feed System to Deliver Ample Water Regardless of Position

PART NO.	MAXIMUM RPMS	RECOMMENDED FOR	DESCRIPTION
PSC-600	8,500	Cutting/Grinding	Pneumatic Stone Cutter
AIR-008		Pneumatic Tools	Rust Inhibitor Oil 8oz (237ml)

Introducing A New and Improved  
Version of Our Popular **AWS-125...**

# ESC-125

WET/DRY STONE CUTTER

**OSHA<sup>®</sup>**  
COMPATIBLE

**DRY**

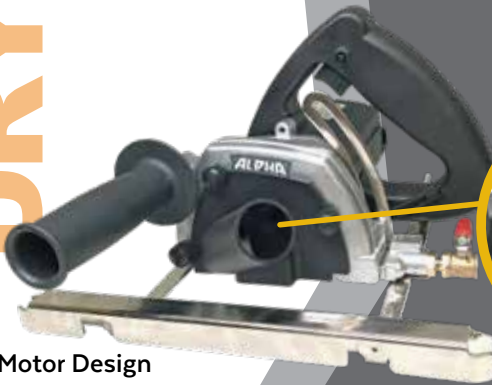

Dust Cover For HEPA  
Vacuum Connection

- New Motor Design
- Kink Free Hybrid Water Supply Hose with Quick Change Connector

**WET**



Newly Designed  
Water Jet

\*Blade not included

Quick Change  
Connector



**GUIDE RAIL**



(optional)

**ASC-5CSM**

## ESC-125 / ESC-225

## WET/DRY STONE CUTTER



- Precision Cuts Everytime
- Powerful Motor For Use On Granite, Quartz Surfaces, Marble, Limestone, Concrete and Sintered Slabs
- Water-Feed Supply Eliminates The Harmful Dust Particles
- Base Plate Allows Guides To Be Used in Multiple Ways
- Dust Cover for HEPA Vacuum Connection
- New Clamping System Ensures Cutting Stability
- Included Self-Stick Felt Strips Protects The Work Surface From Scratches
- Built-In GFCI (Ground Fault Circuit Interrupter)
- Great For Use With Curve Cutting Blades
- One Year Warranty (See manual for details)

SPECIFICATION	DATA
Model	ESC-125/ESC-225
Rating	110 Volts/220 Volts
Amperage	11.2A/5.5A
Power	1200W
No Load Speed (min-1)	12,000 RPM
Weight	8.9 lbs (4.0 kgs)
Arbor	7/8" (22.23mm)
Cutting Disc Diameter	5" (125mm)
Plug Type	A (110V)/C(220V)
Cord	15ft (4.5m)Single-Phase
Max. Cutting Depth	1-5/8" (41mm)

ITEM	QUANTITY
Dust Cover	1
Knob Bolt	3
TT Ruler Guide	1
Water Hose Assembly	1
Quick Connect Adapter	1
Side Handle	1
Screw (M6x30-Left)	1
Flange 3	1
Carbon Brush Set	1
T-Handle Wrench	1
Open-End Wrench (22mm)	1
Self-stick Felt Strip Set	1
GFCI	1
EasyOn-EasyOff Sleeve	1
SS Flat Head Screw (M4×10)	3
Water Valve Assembly	1

PART NO.	SIZE	TYPE	ARBOR(S)	DESCRIPTION
ESC-125	5"	110V	7/8" (22.23mm)	Wet/Dry Stone Cutter
ESC-225	5"	220V	7/8" (22.23mm)	Wet/Dry Stone Cutter



**COUNTERTOP TRIM KIT**

**COMPLETE TRIM KIT  
FOR A CUSTOM-LOOK**

Part number: 5480-4150



**COUNTERTOP  
TRIM KIT**



**Complete  
Trim Kit for a  
Custom Look**

**INCLUDES:**

- Wet/Dry Stone Cutter  
ESC-125
- 5" Eclipse Blade  
DEE005
- 5" Carriage Assembly  
for Stone Cutter  
ASC-5CSM
- 4' Guide Rail with Clamps  
ASC-GR04

- Recommended for Hard Surfaces
- Eclipse II Blade has 8mm Tall Diamond Layer for a Long Life
- Perfect for your Stone Tile Application
- High-End General Purpose Turbo Blade for Stone Fabricators
- Consistent Performance without Chipping
- Kit Contains: ESC-125 Stone Cutter, 5" Carriage Assembly, 5" Eclipse II Blade and 4' Guide Rail
- One Year Tool Warranty (*See manual for details*)

PART NO.	DESCRIPTION
5480-4150	Countertop Trim Kit (ESC-125)

# PSC-150

## MITER CUTTING KIT

**STEP 1**  
Set Up  
Guide Rail



**STEP 2**  
Miter Cut  
One

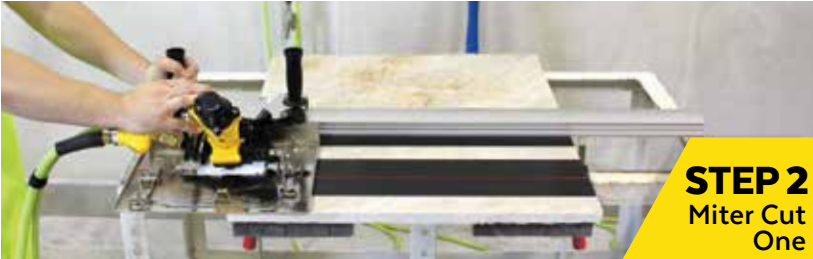

**STEP 3**  
Miter Cut  
Two



**SAVE TIME & INCREASE  
PRODUCTIVITY**

PART NUMBER: 5480-5100

Kit includes: (2) PSC-150, (2) ASC-6CSM, ASC-GR04, ASC-GR07, ASC-GR12, BAB0650

**PSC-150 MITER CUTTING KIT**

**COMPLETE MITER CUTTING KIT FOR A WATERFALL EDGE**

Part number: 5480-5100



**A Complete Miter Cutting Kit For That Perfect Waterfall Edge**

**INCLUDES:**

- Pneumatic Stone Cutter**  
(2) PSC-150
- 6" Carriage Assembly for Pneumatic Stone Cutter**  
(2) ASC-6CSM
- Guide Rails with Clamps**  
4', 7', 12' (Connector & 4 Screws)  
ASC-GR04 | ASC-GR07 | ASC-GR12
- Surface Protection Tape**  
BAB0650

- One System for Straight, Curve and Miter Cuts
- One-Time Easy Setup on the Guide Rail Allows for Two Different Miter Cut Positions for Lamination Prep
- Precise Miter Cutting for Laminated Waterfall Edges and Book Matching
- Miter Cut 3/4" (2cm) Material with Ease

PART NO.	DESCRIPTION
5480-5100	Miter Cutting Kit (PSC-150)

# STONE CUTTER

## PSC-150

## PNEUMATIC STONE CUTTER



- 2 HP Pneumatic Powered Motor with Speed Governor
- Capable of Miter Cutting 1-1/4" Material With Ease
- Kink-Free Water and Air Hoses for Easy Maneuverability and Reducing Operator Fatigue
- Great For Sink-Hole Cutting, Groove Cutting and Rodding Applications
- Comes With An Eclipse II 6" Blade and a Bottle of Rust Inhibitor Oil
- Can Be Used Wet or Dry
- One Year Warranty (*See manual for details*)

SPECIFICATION	DATA
Model	PSC-150
Air Pressure	90 PSI
Air Consumption Min	32 CFM / 1HP*
Air Consumption Max	48 CFM / 2HP
No Load RPM	8,500 RPM
Air Inlet	3/8" NPSM
Water Inlet	1/4" BSPP
Arbor	7/8" (22mm)
Max. HP	2.0HP
Cutting Disc Diameter	6" (150mm)
*To control the amount of CFM required, use the reduced flow air inlet fitting 3001-0084	



**2,000 Hour  
Duty Cycle**

ITEM	QUANTITY
Flanges	3
Bolts (M6X30 Left) / (M6x20 Left)	2
Side Handle	1
Combination Wrench (9mm)	1
Hex Wrench (5mm)	1
Open End Spanner Wrench (22mm)	1
Air Hose (15ft / 4.5m)	1
Water Hose (15ft / 4.5m)	1
Rust Inhibitor Oil (8oz / 237ml)	1
Alpha® Eclipse II 6" Blade (DEE006)	1
Reduced Flow Air Inlet Fitting (3001-0084)	1

PART NO.	SIZE	RECOMMENDED FOR	ARBORS/ RPMS	DESCRIPTION
PSC-150	6"	Granite/Engineered Stone	7/8", 22mm	Pneumatic Stone Cutter
DEE006	6"	2.1mm	10,100	7/8", 5/8", ∅
AIR-008		Pneumatic Tools		Rust Inhibitor Oil 8oz (237ml)
5480-5100				PSC-150 Miter Cutting Kit

# STONE CUTTER

## AWS-110 / AWS-220

## WET STONE CUTTER



- Produces Straight and True Cuts Everytime
- Powers Through Hard Dense Materials, Such As, Porcelain, Hard Red Granites and Engineered Stone
- Water-Feed Supply Eliminates The Harmful Dust Particles
- Base Plate Allows Guides To Be Used in Multiple Ways
- Included Self-Stick Felt Strips Protects The Work Surface From Scratches
- Built-In GFCI (Ground Fault Circuit Interrupter)
- *One Year Warranty (See manual for details)*



SPECIFICATION	DATA
Model	AWS-110/AWS-220
Rating	110/220 Volts
Amperage	11.2A (5.5A)
Power	1200W
No Load Speed (min-1)	13,000 RPM
Weight	6.8 lbs (3.1 kgs)
Arbor	20mm
Cutting Disc Diameter	4" (100mm), 4-1/2" (115mm)
Maximum Cutting Depth	1-1/4" (32mm)

ITEM	QUANTITY
Ground Fault Circuit Interrupter	1
Water Valve and Hose	1
Water Attachment Assembly	1
Spanner Wrench M22	1
TT Ruler Guide	1
T-Handle Wrench	1
Extra Carbon Brush Set	1
Self-stick Felt Strip Set	1

PART NO.	SIZE	TYPE	ARBOR(S)	DESCRIPTION
AWS-110	4-1/2"	110V	20mm	Wet Stone Cutter
AWS-220	4-1/2"	220V	20mm	Wet Stone Cutter

# STONE CUTTER

## ECC-125

## ECOCUTTER



- Virtually Dust-Free
- Portable Cutting System
- Accurate Cutting Performance
- Eliminates Downtime
- Built-in In-line circuit breaker
- Great for Grout Removal, Crack Chasing & Concrete Profiling
- One Year Warranty (*See manual for details*)

SPECIFICATION	DATA
Model	ECC-125
Rating	110 Volts
Amperage	11.2A
Power	1200W
No Load Speed (min-1)	12,000 RPM
Weight	9.5 lbs (4.3 kgs)
Arbor	7/8" (22.23mm)
Cutting Diameter	5" (125mm)
Maximum Cutting Depth	1-1/8" (29mm) (Without Ecocutter Table)

ITEM	QUANTITY
Dust Hose	1
Dust Gate	1
Side Handle	1
Hexagon Ring Spanner	1
Wrench	1
Dust Bag	1
TT Ruler	1
Hook & Loop Strap	2

PART NO.	SIZE	TYPE	ARBOR(S)	DESCRIPTION
ECC-125	5"	110V	7/8" (22.23mm)	Ecocutter
133544	17" x 13-1/2" x 12"			Dust Bag w/strap
ECO-CARS		Steel		Dust Bag Carriage (includes Dust Bag)

DUST BAG CARRIAGE



## ECC-KIT

## DRY PORCELAIN PAVER TILE CUTTING SYSTEM

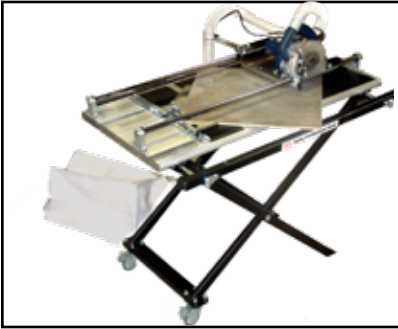

- Virtually Dust-Free
- Portable Cutting System
- Accurate Cutting Performance
- Eliminates Downtime and The Messy Cleanup
- Built-In Breaker Assembly
- Holds 3/4" Thick Porcelain Paver Tile
- One Year Tool Warranty (*See manual for details*)

SPECIFICATION	DATA
Model	ECC-KIT (ECC-125)
Rating	110 Volts
Amperage	11.2A
Power	1200W
No Load Speed (min-1)	12,000 RPM
Weight	9.5 lbs (4.3 kgs)
Arbor	7/8" (22.23mm)
Cutting Diameter	5"(125mm)
Maximum Cutting Depth	1-1/8" (29mm) (without Ecocutter Table)

EQUIPMENT INCLUDED	QUANTITY
ECC-125	1
Dust Hose	1
Dust Gate	1
Side Handle	1
Hexagon Ring Spanner	1
Wrench	1
Dust Bag	1
TT Ruler Guide	1
Hook & Loop Strap	2
Ecocutter Table	1
Ecocutter Stand	1
Alpha® Ultracut GPM 5"	1

PART NO.	SIZE	TYPE	ARBOR(S)	DESCRIPTION
ECC-KIT	5"	110V	7/8" (22.23mm)	Dry Cutting System
ECC-125	5"	110V	7/8" (22.23mm)	Ecocutter
133544	17"x13-1/2 x 12"			Dust Bag w/strap
ECC-STAND				Dry Cutting System Stand
ECC-TABLE				Dry Cutting System Table
170005				Ecocutter DVD
PART NO.	SIZE	THICKNESS	MAX RPM	ARBOR(S)
GPM0578	5"	1.5mm	12,200	7/8"



## PSG-658

## HIGH-PERFORMANCE PNEUMATIC GRINDER



**Enhanced  
Spindle Shaft  
for Easy  
Tool Removal**  
(Wrench Included)

- Center Water-Feed System to Deliver Ample Water Regardless of Position
- 15ft. All-Weather Hoses with Flexibility Down To -40°F Or +140°F (-40°C To +60°C)
- Newly Developed Motor Produces More Power
- Lightweight and Ergonomically Designed for Better Maneuverability
- Spring Return Throttle to Avoid Accidental Start
- Composite End Case to Prevent Freezing Hands
- Unique Center Water Feed System Delivers Ample Water Through the Shower Bolt with 4 Water Passage Holes
- Silicon Gear Head Cover Provides Cushion and Keeps Hands Warm
- Enhanced Spindle Shaft for Easy Tool Removal (Wrench included)
- One Year Warranty (See manual for details)

SPECIFICATION	DATA
Model	PSG-658
Air Pressure	85 PSI (6 Bar)
Air Consumption	15 CFM (425L/min)
Weight	2.9 lbs (1.3 kgs)
No Load RPM	8,500 RPM
Air Inlet	1/4" BSPP
Water Inlet	1/8" BSPP
Spindle	5/8"-11
Length	7-1/2" (190.5mm)

ITEM	QUANTITY
Air Hose (15ft / 4.5m)	1
Water Hose (15ft / 4.5m)	1
Side Handle (reversible)	1
Rust Inhibitor Oil (6.7oz/200ml)	1
Screw (w/O-Ring Seal for Oil Port)	1
Exhaust Hose & Clamp	1
Spring Washer	1
6" Safety Guard	1
Double End Wrench (19mm/22mm)	1
Phillips Screwdriver	1
Water Quick Coupler w/Shut-off Valve	1
O-Ring (O-Ring for Water Valve Repair)	1
Hex Wrench (6mm)	1

PART NO.	MAXIMUM RPMS	RECOMMENDED FOR	DESCRIPTION
PSG-658	8,500	Cutting/Grinding	Pneumatic Stone Cutter
AIR-008		Pneumatic Tools	Rust Inhibitor Oil 8oz (237ml)
PSG-658M		PSG-658+Rust Inhibitor Oil ONLY (No other accessories)	



## PSG-125

## PNEUMATIC GRINDER



- Powerful 1.4 HP motor with speed control governor
- Compact ergonomic aluminum body
- Reversible safety lever throttle
- Two auxiliary handle positions
- Built-in oil port for daily maintenance
- Adjustable rotating exhaust
- Wet cutting kit available
- One Year Warranty (See manual for details)

SPECIFICATION	DATA
Model	PSG-125
Air Pressure	90 PSI
Air Consumption	33 CFM / 934L/min
No Load Speed	12,000 RPM
Weight	4.6 lbs / 2.1 kgs
Length	11-3/4" / 298mm
Air Inlet	3/8" NPSM
Spindle	5/8"-11
Max. Disc Capacity	5" x 1/4" x 7/8"
Max. HP	1.4 HP



ITEM	QUANTITY
Blade Safety Guard	1
Lock Nut with 7/8" Arbor	2
Inner Flange	2
Side Handle	1
Pin Wrench	1
Double End Wrench (1" / 32mm)	1
Handle Bracket	1
Washer and Seal Set	1
Screw	1
Rust Inhibitor Oil (8oz / 237ml) (AIR-008)	1
Air Hose Assembly (15ft / 4.5m)	1



PART NO.	SIZE	ARBOR(S)	DESCRIPTION
PSG-125	5"	7/8"	Pneumatic Grinder

## PSG-125

## DIAMOND CUTTING KIT



- Fits wide kerf blades for tuck pointing, crack chasing and grout removal
- Compact ergonomic aluminum body
- Reversible safety lever throttle
- Two auxiliary handle positions
- Adjustable rotating exhaust
- One Year Tool Warranty (*See manual for details*)



\*(Blade not included)

PART NO.	DESCRIPTION
5480-1301	PSG-125 Diamond Cutting Kit

## PSG-125

## DUST-FREE GRINDING KIT



- Great for surface preparation on concrete, wood, composite or other surfaces
- Compact ergonomic aluminum body
- Powerful 1.4 HP motor with speed control governor
- Reversible safety lever throttle
- Adjustable rotating exhaust
- Removable flat cover allows grinding right to the edge
- One Year Tool Warranty (*See manual for details*)



\*(Grinding Wheel not included)

PART NO.	DESCRIPTION
5480-1302	PSG-125 Grinding Kit

# VDP-700

## VARIABLE SPEED ROTARY POLISHER



## VDP-700

## WET/DRY VARIABLE SPEED ROTARY POLISHER



\*Backer and Pad Not Included

- Variable Speed 700-3500 RPM with Soft Start
- Designed For The Polishing Professional
- Heavy-Duty Precision Gear System
- Powerful 11.0 Amp (rated) Motor
- Built-in Speed Stabilizer for Constant Speed Output
- Configured with A Long-life Motor and Carbon Brushes
- 25ft. 14 AWG Electrical Power Cord
- Lightweight for Better Manueverability
- Industrial Quality Polisher
- C-Handle & Side Handle for User Convenience
- One Year Warranty (*See manual for details*)

SPECIFICATION	DATA
Model	VDP-700/VDP-714
Rating	120/230 Volts
Amperage	11.0A / 5.4A
Power	1250W (Rated), 1900W (Maximum)
No Load Speed (Variable)	700~3500 RPM w/Soft Start
Weight	6.4 lbs (2.9 kgs)
Spindle	5/8"-11 / M14-2
Power Supply	Single-phase AC, 50/60Hz
Plug Type	A (120V) / C(230V)
Cord	25ft (7.6m) / 16.8ft (5.1m) (14 AWG)
Backing Plate Size	7" (178mm) (Maximum)
Polishing Disc Size	9" (228mm) (Maximum)

ITEM	QUANTITY
Spanner Wrench	1
Hex Wrench	1
C-Handle w/Mounting Screws	1
Side Handle	1
Extra Carbon Brush Set	1



\*Backer and Pad Not Included

PART NO.	SIZE	MAXIMUM RPM	TYPE	THREADS	DESCRIPTION
VDP-700	7"	700-3500	120V	5/8"-11	Variable Speed Rotary Polisher
VDP-714	7"	700-3500	230V	M14-2	Variable Speed Rotary Polisher

## WET SANDING/ POLISHING KIT

KIT Part # WSPKIT



(optional)

## WOOL PADS

**REMOVES DEEP SCRATCHES WITH EASE**



- Removes Deep Scratches, Overspray & Severe Swirl Marks With Ease
- Premium Performance and Heat-Resistant
- Smoother Handling and Reduced Vibration
- For Use on Rotary Polishers
- Great for Heavy Oxidation

PART NO.	SIZE	TYPE	RECOMMENDED FOR	MATERIAL	GRIT
WP003160	3"	Hook & Loop	Heavy Cutting	High-Nap Knitted Wool	T160
WP006160	6"	Hook & Loop	Heavy Cutting	High-Nap Knitted Wool	T160
WP007160	7"	Hook & Loop	Heavy Cutting	High-Nap Knitted Wool	T160

## ROTARY BACKER PAD

**FOR USE ON ROTARY POLISHERS**



- Soft Molded Urethane With Flexible Edge
- Urethane Backing Makes for Greater Flexibility and Excellent Polishing
- Ideal for Contour Polishing
- For Use with Foam, Wool & Microfiber Pads
- Hook & Loop Allows for Fast Pad Changes
- Well Balanced for Smooth Polishing
- Absorbs Vibrations and Has Great Rebound Performance



*Hook & Loop*



*Adhesive*

PART NO.	SIZE	TYPE	RECOMMENDED FOR	THREADS
MP358HL	3"	Hook & Loop	Foam, Wool & Microfiber Pads	5/8"-11
MP558HL	5"	Hook & Loop	Foam, Wool & Microfiber Pads	5/8"-11
MP658HL	6"	Hook & Loop	Foam, Wool & Microfiber Pads	5/8"-11
MP758HL	7"	Hook & Loop	Foam, Wool & Microfiber Pads	5/8"-11
MP858HL	8"	Hook & Loop	Foam, Wool & Microfiber Pads	5/8"-11
MP858GL	8"	Adhesive	Foam, Wool & Microfiber Pads	5/8"-11

## DIAMOND FACE FOAM PADS

DESIGNED FOR BOTH  
ROTARY & DA POLISHER



# DIAMOND FACE FOAM PADS

- **DESIGNED FOR BOTH ROTARY & DA POLISHERS**
- **REDUCED POLISH SPLASH AND HEAT BUILD-UP**
- **SMOOTHIER HANDLING AND REDUCED VIBRATION**
- **CAN WITHSTAND HIGH TEMPERATURES AND WATER WASH**
- **GREAT FOR USE ON SCRATCH RESISTANT/CERAMIC PAINTS**

PART NO.	SIZE	TYPE	COLOR	RECOMMENDED FOR	GRIT
FPG04120	4"x1"	Hook & Loop	Green	High Cutting	T120
FPG06120	6"x1"	Hook & Loop	Green	High Cutting	T120
FPG07120	7"x1"	Hook & Loop	Green	High Cutting	T120
FPY04080	4"x1"	Hook & Loop	Yellow	Medium Cutting	T80
FPY06080	6"x1"	Hook & Loop	Yellow	Medium Cutting	T80
FPY07080	7"x1"	Hook & Loop	Yellow	Medium Cutting	T80
FPB04020	4"x1"	Hook & Loop	Black	Finishing/Polishing	T20
FPB06020	6"x1"	Hook & Loop	Black	Finishing/Polishing	T20
FPB07020	7"x1"	Hook & Loop	Black	Finishing/Polishing	T20
FPR04010	4"x1"	Hook & Loop	Red	Finishing/Finessing	T10
FPR06010	6"x1"	Hook & Loop	Red	Finishing/Finessing	T10
FPR07010	7"x1"	Hook & Loop	Red	Finishing/Finessing	T10

**VSP-320 / VSP-340**

**VARIABLE SPEED  
WET POLISHER**



- Variable Speed 700-2500 RPM
- Heavy-Duty Gear System with Step-Down Transmission
- 15ft. Flexible All-Weather Water Hose
- 15ft. Electrical Power Cord Has An Inline GFCI
- EasyOn-EasyOff Sleeve Improves Maneuverability
- Adjustable Splash Guard
- Center Water-Feed System
- Ventilation Cap Diverts Water from Getting Into Motor Housing
- C-Handle & Side Handle for User Convenience
- One Year Warranty (See manual for details)

SPECIFICATION	DATA
Model	VSP-320/VSP-340
Rating	120 Volts/230 Volts
Amperage	7.0A/3.5A
Power	800W
No Load Speed (Variable)	700~2500 RPM
Weight	7.3 lbs (3.3 kgs)
Spindle	5/8"-11/M14-2
Power Supply	Single-phase AC, 50/60Hz
Plug Type	A (120V)/C (230V)
Cord	15ft (4.5m)
Polishing Disc Size	4" (100mm)

PART NO.	TYPE	DESCRIPTION
VSP-320	120V	Variable Speed Wet Polisher
VSP-340	230V	Variable Speed Wet Polisher

ITEM	QUANTITY
Ground Fault Circuit Interrupter*	1
Flexible Hose w/ Garden Hose Adapter*	1
Wrench	1
C-Handle w/ Mounting Screws*	1
Side Handle (Reversible)	1
Extra Carbon Brush Set	1
Ventilation Cap w/ Rubber Band*	1
Splash Guard w/ Clamp	1
EasyOn-EasyOff Sleeve*	1



\*Factory Attached



**TILE BULLNOSE KIT**

**CREATES A FACTORY FINISH EASILY**



- Designed To Create A Bullnose Edge On Tile or Stone and Polish It To A Factory Quality Finish
- Goof-Proof Hand-Held Application
- Quality Finish Without The Factory
- Save Time and Money
- Kit Contains: VSP-320 Polisher, Profiler B, 4" Ceramica EX Polishing Discs, 4" Flexible Backer Pad and Apron
- One Year Tool Warranty (See manual for details)



**PROFILING**



**POLISHING**



**BULLNOSE EDGES**

**KIT INCLUDES:**  
 VSP-320, PFB101, GP45/8PD, EX40200R, EX40500R, EX41000R, EX42000R, EX43000R and APRON2000

PART NO.	DESCRIPTION
5480-1400	Tile Bullnose Kit (VSP-320)



**WDP-320**

**WET/DRY VARIABLE SPEED POLISHER**



- Variable Speed Range of 700 - 2,500 RPM
- Wet/Dry Hybrid Polisher with The Ecoguard G Attached for Tile Edge Polishing Without The Typical Mess
- Heavy-Duty Gear System Includes A Step-Down Transmission
- 15ft. Water Hose Is All-Weather Flexible & Kink-Free
- Includes Side Handle for Edge Applications
- Fits 5" Discs
- Polish or Grind Right Up To The Wall
- 15ft. Electrical Power Cord Has An Inline GFCI
- Combine with HEPA Vacuum for A Virtually Dust-Free Solution
- One Year Warranty (*See manual for details*)

ITEM	QUANTITY
Ground Fault Circuit Interrupter*	1
Water Hose Assembly*	1
Water Spray Value Assembly	1
Stainless Steel Hose Band	1
Rubber Band	1
Open End Wrench	1
Pin Wrench	1
C-Handle*	1
Side Handle (reversible)	1
Extra Carbon Brush Set	1
Rubber Hose Adapter	1
Ventilation Cap*	1
Ecoguard G*	1
Flange & Lock Nut Set	1
EasyOn-EasyOff Sleeve*	1

\*Factory Attached

SPECIFICATION	DATA
Model	WDP-320
Rating	120 Volts
Amperage	7.0A
Power	800W
No Load Speed (Variable)	700~2500 RPM
Weight	7.3 lbs (3.3 kgs)
Spindle	5/8"-11



PART NO.	TYPE	DESCRIPTION
WDP-320	120V	Wet/Dry Variable Speed Polisher

## AIR-680UW

## HIGH-PERFORMANCE UNDERWATER PNEUMATIC POLISHER



- Central Water-Feed System Delivers Ample Water Regardless of Position for Plaster Polishing
- No-Load RPM- 4,000
- 15ft. All-Weather Air & Water Hoses with Flexibility Down To -40°F Or +140°F
- 30ft. All-Weather Air Hose with Flexibility Down To -40°F Or +140°F
- 27ft. Flexible Exhaust Hose included
- 7" Flexible Backer Pad included
- Lightweight and Ergonomically Designed for Better Maneuverability
- Side and C-Handle are Standard Accessories
- Enhanced Spindle Shaft for Easy Tool Removal (Wrench Included)
- One Year Warranty\* (\*See manual for details)

SPECIFICATION	DATA
Model	AIR-680UW
Air Pressure	85 PSI (6 Bar)
Air Consumption	15 CFM (425L/min)
Weight	2.64lbs (1.2 kgs)
No load Speed	4,000 RPM
Air Inlet	1/4" BSPP
Water Inlet	1/8" BSPP
Spindle	5/8"-11 / M14-2

ITEM	QUANTITY
Air Hose (15ft / 4.5m)	1
Water Hose (15ft / 4.5m)	1
Air Hose (30ft / 9.0m)	1
Side Handle (reversible)	1
C-Handle	1
Double End Wrench (19mm/22mm)	1
Screw (w/O-Ring Seal for Oil Port)	1
Phillips Screwdriver (P1)	1
Exhaust Hose with Clamp	1
Flexible Vacuum Hose (27ft / 8.1m)	1
Water Quick Coupler w/Shut Off Valve	1
Rust Inhibitor Oil (6.7oz / 200ml)	1
Rotary Backer Pad 7" (MP758HL)	1



**Enhanced Spindle Shaft for Easy Tool Removal**

(Wrench included)



PART NO.	MAXIMUM RPM	THREADS	RECOMMENDED FOR	DESCRIPTION
AIR-680UW	4,000	5/8"-11	Underwater Wet Polishing, Drilling & Profiling	Pneumatic Polisher

**AIR-830 / AIR-834**

**HIGH-PERFORMANCE  
PNEUMATIC POLISHER**



AIR-830

**4,000 RPM Gear Set**  
for Best Quality Results

SPECIFICATION	DATA
Model	AIR-830/AIR-834
Air Pressure	85 PSI (6 Bar)
Air Consumption	15 CFM (425L/min)
Weight	2.75 lbs (1.2 kgs)
No load Speed	4,000 RPM
Air Inlet	1/4" BSPP
Water Inlet	1/8" BSPP
Spindle	5/8"-11 / M14-2

PART NO.	MAXIMUM RPM	THREADS	RECOMMENDED FOR
AIR-830	4,000	5/8"-11	Wet Polishing, Drilling & Profiling
AIR-834	4,000	M14-2	Wet Polishing, Drilling & Profiling
AIR-830M	AIR-830+Rust Inhibitor Oil ONLY (No other accessories)		
AIR-834M	AIR-834+Rust Inhibitor Oil ONLY (No other accessories)		

**AIR-850 / AIR-854**

**HIGH-PERFORMANCE  
PNEUMATIC POLISHER**



AIR-850

**5,500 RPM Gear Set**  
for Best Productivity

SPECIFICATION	DATA
Model	AIR-850/AIR-854
Air Pressure	85 PSI (6 Bar)
Air Consumption	15 CFM (425L/min)
No load Speed	5,500 RPM
Weight	2.75 lbs (1.2 kgs)
Air Inlet	1/4" BSPP
Water Inlet	1/8" BSPP
Spindle	5/8"-11 / M14-2

PART NO.	MAXIMUM RPM	THREADS	RECOMMENDED FOR
AIR-850	5,500	5/8"-11	Wet Polishing, Drilling & Profiling
AIR-854	5,500	M14-2	Wet Polishing, Drilling & Profiling
AIR-850M	AIR-850+Rust Inhibitor Oil ONLY (No other accessories)		
AIR-854M	AIR-854+Rust Inhibitor Oil ONLY (No other accessories)		

**Ergonomic** and lightweight  
for **better maneuverability**

**AIR-830**



Part # AIR-008  
Rust Inhibitor Oil (6.7oz / 200ml)

**AIR-850**

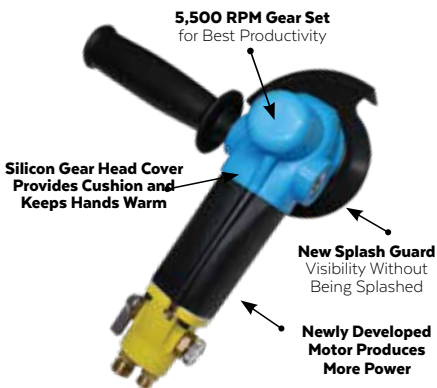

**FEATURES:**

- *Newly Developed Motor Produces More Power with Hybrid Vanes*
- *Silicon Gear Head Cover Provides Cushion and Keeps Hands Warm*
- *New Splash Guard Allows for Better Visibility Without Being Splashed*
- *Enhanced Spindle Shaft for Easy Tool Removal (Wrench Included)*
- *One Year Warranty (See manual for details)*

**ITEMS INCLUDED:**

ITEM	QUANTITY
Air Lead Hose 15ft. (4.5m)	1
Water Hose 15ft. (4.5m)	1
Side Handle (reversible)	1
Rust Inhibitor Oil (1oz / 30cc) (Replace with: AIR-008)	1
Screw (w/ O-Ring Seal for Oil Port)	1
Exhaust Hose with Clamp	1
Spring Washer	1
Splash Guard	1
Double End Wrench (19mm / 22mm)	1
Phillips Screwdriver	1
Water Quick Coupler w/ Shut-off Valve	1
O-Ring (O-Ring for Water Valve Repair)	1

**AIR-300 / AIR-304**

**MINI PNEUMATIC POLISHER**



- High-Performance, Pneumatic Polishing Tool with A Central Water-Feed System
- No-Load 5,800 RPMs
- Lightweight and Ergonomically Design Reduces Fatigue
- Designed To Easily Maneuver in Small Areas Like Sink Rims and Bowls
- Consumes 10 CFM and Requires 87 PSI
- Only Requires 3HP Compressor
- One Year Warranty (*See manual for details*)

SPECIFICATION	DATA
Model	AIR-300/AIR-304
Air Pressure	87 PSI (0.6Mpa (6 bar))
Air Consumption	10 CFM (280L/Min)
No Load Speed	5,800 RPM
Weight	1.6 lbs / .731 kgs
Air Inlet	1/4" BSPT
Water Inlet	1/4" BSPP
Spindle	5/8"-11/M14-2



ITEM	QUANTITY
Air Hose 10ft (3m)	1
Water Hose 10ft (3m)	1
Faucet/Garden Hose Adapter	1
Wrench (17mm)	1
Rust Inhibitor Oil (1oz / 30cc) (Replace with: AIR-008)	1



PART NO.	MAXIMUM RPM	THREADS	RECOMMENDED FOR	DESCRIPTION
AIR-300	5,800	5/8"-11	Wet Polishing	Mini Pneumatic Polisher
AIR-304	5,800	M14-2	Wet Polishing	Mini Pneumatic Polisher
AIR-008			Pneumatic Tools	Rust Inhibitor Oil 8oz (237ml)

# BEVELING BASE SYSTEM

## BEVELING AUXILIARY BASE

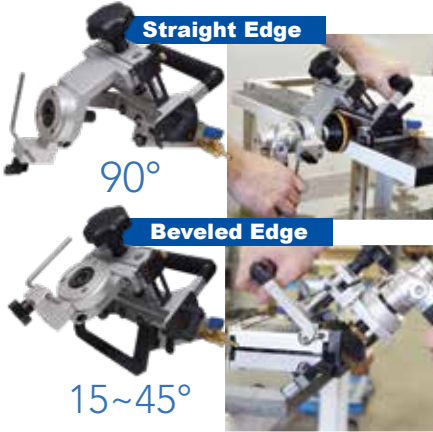

## A PRECISION GRINDING AND POLISHING TOOL

- Transforms Any Polisher or Variable Speed Grinder Into a Precision Straight and Beveled Edge Polishing Tool
- Grind and Polish from 15 degree Hollywood Bevel to 45 degree Beveled Edge or Straight Edge
- Excellent for Preparing Surfaces for Seamless Countertop Installations
- Designed to fit Polishers/Sanders/ Variable-Speed Grinders with 5/8"- 11 or M14-2 Spindle
- Grind and Polish Straight Edges with Ease
- Exterior Water-Feed System Included



SPECIFICATION	DATA
Model	BAB1590 / BAB1590-M14
Beveling Angle	15°~45°
Beveling Depth	3/8" (10mm)
Max. Straight Angle	90°
Max, Pad Size	4" (100mm)
Spindle	5/8"-11 / M14-2
Weight	3.57 lbs (1.62 kgs)

ITEM	QUANTITY
Universal Adapter Assembly	1
Clamping Base for 15°~45°	1
Screws	1
Clamping Base for 90°	1
Water Hose	1
Water Valve	1
Water Hose Assembly (10ft / 3m)	1
Hex Wrench (5mm)	1
Spanner	1

PART NO.	TYPE	RECOMMENDED FOR
BAB1590	Beveling Auxiliary Base 5/8"-11	Pneumatic/Electric Polishers
BAB1590-M14	Beveling Auxiliary Base M14-2	Pneumatic/Electric Polishers
BAB0650	Surface Protection Tape 6" x 164'	Most Surfaces



## BEVELING BASE STARTER KIT

CREATE A PRECISE EDGE -  
MITER, BEVELED OR STRAIGHT

Part number: 5480-2200  
5480-2202



# BEVELING BASE STARTER KIT



## A Precision Grinding and Polishing Tool

**INCLUDES:**

**Beveling Auxiliary Base**

BAB1590/BAB1590-M14

**Surface Protection Tape**

BAB0650

**Carriage Assembly  
for Beveling Base**

BAB-CASM

**Guide Rails with Clamps**

4', 7', 12' (Connector & 4  
Screws)

ASC-GR04 | ASC-GR07 | ASC-GR12

- Create a Precise Edge whether Mitered, Beveled or Straight
- Perfect on all Materials including Sintered Slabs and Thin Porcelain Panels
- Fabricator's Choice for Seamless Countertop Installations
- Precision Grinding for Perfect Mitered Edge for Lamination
- High-Quality Polishing Results
- Cost Savings when Compared to Expensive Machinery

PART NO.	DESCRIPTION	SPINDLE
5480-2200	Beveling Base Starter Kit	5/8"-11
5480-2202	Beveling Base Starter Kit-M14	M14-2



# BEVELING BASE APPLICATIONS

**POLISH STRAIGHT AND BEVEL EDGE TO A FACTORY FINISH**



**GRIND A MITER EDGE WITH PRECISION**



BEFORE



AFTER

**SURFACE PREPARATION FOR SEAMLESS COUNTERTOP INSTALLATIONS**

## ACCESSORIES



### Turboshine Grinding Tools

*Grind Mitered Edge with Precision  
Grind Hollywood Bevel with Ease  
(See page 66)*



### Turboshine Polishing Tools

*Designed for Polishing Seamless Countertops and Scratch Removal for Natural and Engineered Stones  
(See page 66)*



### Groove Cutter

*Wet Groove Cutting Wheel for Joint Seaming  
(See page 44)*



# CUTTING SYSTEM OVERVIEW

KEY: ● = Highly Recommended ○ = Recommended

DRY CUTTING BLADES						
ALPHA® BLADES	SPECIALTY	BUILDING STONE FABRICATORS	TILE CONTRACTORS	MONUMENT BUILDERS	GENERAL CONTRACTORS	HARDSCAPE
BladeMaster	Demolition/Concrete Cutting				●	●
Contour for Granite / Eng. Stone	Curved Applications	●	○			○
Contour for Porcelain	Curved Applications	●	○			●
Eclipse II	General Purpose	●	○	○	●	○
Eclipse Q	General Purpose	●	○	○	●	○
Hot-Rod	Channel Cutting	●	○	○	○	○
Katana	All Tiles	○	●	○	○	●
Laminam	Laminam by Crossville® / Porcelain Panels	○	●		○	●
Libero	Marble	●	●	○	○	○
Plus	Granite & Harder Materials	●	○	●	○	○
PT Cutter	Hardscape/Concrete Cutting	○	●		○	●
Quad	Flush Cutting	●	○	●	○	○
Rescue Blade	General Purpose	○			○	●
Trim Master	Miter Saws	●	○		○	○
Tuck Point	Tuck Pointing				○	●
Ultracut ABM	Cut-Off Tools	○	○		●	○
Ultracut APR	Flush Cutting	○	○		●	○
Ultracut GPM	Metal & Composite Materials	○	○		●	●
Vortex for Granite	Flush Cutting	●	○	●		○
Vortex for Marble	Flush Cutting	●	○	●		○
WET CUTTING BLADES						
ALPHA® BLADES	SPECIALTY	BUILDING STONE FABRICATORS	TILE CONTRACTORS	MONUMENT BUILDERS	GENERAL CONTRACTORS	HARDSCAPE
BG	Glass Blade for Cordless Saw		●		●	●
BT	Tile Blade for Cordless Saw		●		●	●
Groove Cutter	Groove Cutting	●	○	○	○	○
Knock Out	Granite	●				○
Marble Profile Wheel	Cut & Profile Tile	○	●		○	○
Porcellana	All Tiles	○	●		○	●
Q-Cut	Quartzite & Granite	●	●		○	●
Silencer III	Granite	●	○	●	○	○
Silencer III	Marble	●	○	●	○	○
Silencer III	Porcelain/Crystallized Glass	●	○		○	○
Silencer III	Engineered Stone	●	○		○	○
Silencer III	Dekton®	●	○		○	○
Silencer III	Quartzite	●	○	●	○	○
Silencer VO for Dekton®	V/O Cutting on Dekton®/Porcelain/ Crystallized Glass	●				
Silencer VO for Granite/Quartz Surfaces	V/O Cutting on Granite/Quartz Surfaces	●				
Sonic	Ceramic Tile	○	○		○	○
Vetro	Glass, Tile & Stone	○	●		○	●

Alpha® Dry Blades may also be used wet providing the specified RPM is maintained. However, Alpha® Wet Blades may not be used dry with exception of the Alpha® Sonic (part numbers TS04AL and TS05AL). In all cases, it is important that the application meet the defined use for that specific blade. Different sizes are available for various applications.

Alpha® Dry Blades may also be used wet providing the specified RPM is maintained. However, Alpha® Wet Blades may not be used dry with exception of the Alpha® Sonic (part numbers TS04AL and TS05AL), Q-Cut, (QZ4578 and QZ0578). In all cases, it is important that the application meet the defined use for that specific blade. Different sizes are available for various applications. Please refer to the specific product page or our website for additional product information.

## PLUS

## ULTIMATE DRY BLADE FOR STONE FABRICATORS



- Best Dry Cutting Turbo Blade on the Market
- Perfect for Granite and Engineered Stone
- 8mm Tall Diamond Layer for a Long Life
- Recommended for Hard Concrete
- Chip-Free Cutting on Most Demanding Applications

PART NO.	SIZE	THICKNESS	MAXIMUM RPM	ARBOR(S)
DA04A+	4"	2.1mm	14,500	20mm, 5/8"
DA05A+	4-1/2"	2.1mm	13,200	7/8", 20mm
DA05S	5"	2.1mm	12,200	7/8"
DA06A+	6"	2.1mm	10,100	7/8", 5/8", <math>\diamond</math>
DA07A+	7"	2.3mm	8,400	5/8", <math>\diamond</math>
DA08A+	8"	2.3mm	7,400	5/8", <math>\diamond</math>
DA09A+	9"	2.3mm	6,600	7/8", 5/8"
DA10A+	10"	2.5mm	5,900	1", 7/8", 5/8"
DA11A+	10"	2.5mm	5,900	5/8"
DA12A+	12"	2.5mm	6,200	1", 20mm
DA13A+	12"	2.5mm	6,200	20mm

## QUAD

## ULTIMATE DRY FLUSH CUTTING BLADE



- Requires Quad Drive or Flange Adapter to fit High-Speed Angle Grinder
- Fits most popular High-speed Angle Grinders
- Specially Designed for Flush Cutting
- Best Dry Cutting Turbo Blade on the Market
- Chip-Free Cutting on Most Demanding Applications



PART NO.	SIZE	THICKNESS	MAXIMUM RPM	ARBOR(S)
DA04AH	4"	2.1mm	14,500	20mm Quad Drive
DA05SH	5"	2.1mm	12,200	20mm Quad Drive
DA06AH	6"	2.1mm	10,100	20mm Quad Drive
DA07AH	7"	2.3mm	8,400	20mm Quad Drive
DA08AH	8"	2.3mm	7,400	20mm Flange with 8 holes
DA09AH	9"	2.5mm	6,600	20mm Flange with 8 holes
DA11AH	10"	2.5mm	5,900	20mm Flange with 8 holes

## ECLIPSE II

### HIGH PERFORMANCE DRY BLADE



- High-End General Purpose Turbo Blade for Stone Fabricators
- 8mm tall Diamond Layer for a Long Life
- Perfect for your Stone Tile Application
- Consistent Performance without Chipping
- Recommended for Hard Concrete

PART NO.	SIZE	THICKNESS	MAXIMUM RPM	ARBOR(S)
DEE004	4"	2.1mm	14,500	20mm, 5/8"
DEE045	4-1/2"	2.1mm	13,200	7/8", 20mm
DEE005	5"	2.1mm	12,200	7/8"
DEE006	6"	2.1mm	10,100	7/8", 5/8", ⚡
DEE007	7"	2.3mm	8,400	5/8", ⚡
DEE008	8"	2.3mm	7,400	5/8", ⚡

## ECLIPSE Q

### HIGH PERFORMANCE DRY FLUSH CUTTING BLADE



- Requires Quad Drive or Flange Adapter to fit High-Speed Angle Grinder
- 8mm tall Diamond Layer for a Long Life
- Specially Designed for Flush Cutting
- High-End General Purpose Turbo Blade for Stone Fabricators
- Consistent Performance without Chipping



PART NO.	SIZE	THICKNESS	MAXIMUM RPM	ARBOR(S)	THREADS
DEQ004	4"	2.1mm	14,500	20mm Quad Drive	
DEQ005	5"	2.1mm	12,200	20mm Quad Drive	
DEQ578	5"	2.1mm	12,200	7/8" Quad Drive	
DEQ006	6"	2.1mm	10,100	20mm Quad Drive	
DEQ678	6"	2.1mm	10,100	7/8" Quad Drive	
DEQ007	7"	2.3mm	8,400	20mm Quad Drive	
DEQ008	8"	2.3mm	7,400	20mm Flange with 8 holes	
AAH-7/8		Aluminum Adapter		7/8"	5/8"-11
AAH-20		Aluminum Adapter		20mm	5/8"-11
BAH-5/8		Brass Adapter		20mm	5/8"-11

## KATANA

## ULTIMATE DRY BLADE FOR ALL TILES



- Tile Installer's Choice for Dry Cutting
- Specially Designed for Hard Porcelain Tile & Sintered Slabs
- Best Dry Cutting Tile Blade with Minimal Chipping
- Hybrid Dry Saw Blade for All Tiles
- Can Be used Wet or Dry

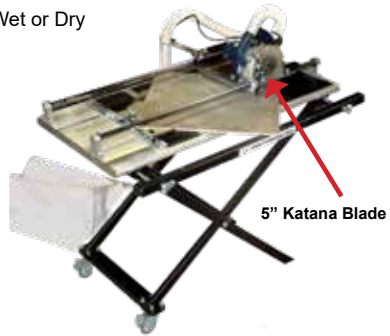

5" Katana Blade

PART NO.	SIZE	THICKNESS	MAXIMUM RPM	ARBOR(S)
DPT100	4"	1.4mm	14,500	20mm, 5/8"
DPT115	4-1/2"	1.4mm	13,200	7/8", 20mm
DPT125	5"	1.4mm	12,200	7/8"
DPT150	6"	1.4mm	10,100	7/8", 5/8", <img alt="arrow icon" data-bbox="785 565 805 575"/>



ECLIPSE II



KATANA

**TUCK POINT**

**HIGH PERFORMANCE DRY  
BLADE FOR TUCK POINTING**



- Virtually Dust-Free Application with Ecoguard W5 and Vacuum
- Formulated for Aggressive Cutting and Long Life
- Best Tuck Pointing Blade on the Market
- Reliable Proven Performer
- Can be used Wet or Dry

PART NO.	SIZE	THICKNESS	MAXIMUM RPM	ARBOR(S)
TP04SP	4"	6mm	14,500	7/8", 5/8"



## LIBERO

## ULTIMATE DRY BLADE FOR MARBLE



- Specially Designed for Marble and Limestone
- Recommended for Onyx
- Highest Quality Diamond Edge for Chip-Free Cutting
- Best Dry Cutting Electroplated Blade on the Market
- Precise Cutting Performance on Softer Stone

PART NO.	SIZE	THICKNESS	MAXIMUM RPM	ARBOR(S)
DL04A+	4"	0.8mm	14,500	20mm, 5/8"
DL05A+	4-1/2"	0.8mm	13,200	7/8", 20mm
DL05S	5"	1.0mm	12,200	7/8"
DL06A+	6"	1.2mm	10,100	7/8", 5/8", 
DL07A+	7"	1.4mm	8,400	5/8", 

## TRIM MASTER

## DRY BLADES FOR MITER SAWS



- 8mm tall Diamond Layer for a Long Life
- Great for Back Splash Cutting
- Perfect for Granite and Engineered Stone
- Best Dry Cutting Blade for Miter Saw
- Consistent Performance with Ease of Operation



PART NO.	SIZE	THICKNESS	MAXIMUM RPM	ARBOR(S)
TM10A+	10"	2.2mm	5,900	5/8"
TM12A+	12"	2.5mm	6,200	1", 5/8"

## ULTRACUT GPM SERIES

## VACUUM-BRAZED DIAMOND BLADE



- Cuts most materials without chipping or cracking
- Maintains excellent cutting performance at the maximum cutting depth
- Cuts Engineered Stone, Marble, Limestone, Angle Iron, Pipe, Electrical Conduit, Re-Bar, Metal Stud, Structural Metal, Sheet Metal, Grid, and Stainless Steel, Wood, Plastics, Composite Materials, Masonry and Concrete
- Fits on most popular hand-held electric power tools
- Available in 4", 4-1/2", 5", 6", 7", 8" and 9"

PART NO.	SIZE	THICKNESS	MAXIMUM RPM	ARBOR(S)
GPM0420	4"	1.5mm	14,500	20mm, 5/8"
GPM4578	4-1/2"	1.5mm	13,200	7/8", 20mm
GPM0578	5"	1.5mm	12,200	7/8"
GPM06UN	6"	1.9mm	10,100	7/8", 5/8", ◀
GPM07UN	7"	1.9mm	8,400	7/8", 5/8", ◀
GPM08UN	8"	1.9mm	7,400	7/8", 5/8", ◀
GPM0978	9"	2.2mm	6,600	7/8", 5/8"

## ULTRACUT APR SERIES

## HYBRID BLADE FOR INTRICATE & FLUSH CUTTING



- Unique Design for Flush Cutting Applications
- Removes Anchor Bolts, Concrete Re-Bar and Pipe From Floors and Walls
- Great for Building Contractors and Fabricators Who Work with Metal and Composite Materials
- Accepts Alpha® Exclusive Quad Drive Adapter for Mounting On Angle Grinders for "Flush Cutting"
- Available in 4-1/2", 5" and 7"



PART NO.	SIZE	THICKNESS	MAXIMUM RPM	ARBOR(S)	THREADS
APR45QA	4-1/2"	1.7mm	13,200	20mm, Quad Drive	
APR05QA	5"	1.7mm	12,200	20mm, Quad Drive	
APR07QA	7"	1.9mm	8,400	20mm, Quad Drive	
BAH-5/8			Brass Adapter	20mm	5/8"-11
AAH-20			Aluminum Adapter	20mm	5/8"-11



## LAMINAM®

### RECOMMENDED BLADE FOR CUTTING LAMINAM



- Specially Designed for Laminam® By Crossville®
- Chip-Free Cutting On Thin Porcelain Tile/Panels
- Smooth Continuous Diamond Rim and Bond Hardness Best Suited for Glass Materials
- High-Quality Straight and True Cuts
- Excellent Choice for Plunge Cutting, Trimming Near The Edges and for Cutting An Internal Radius
- Wet/Dry Use



PART NO.	SIZE	THICKNESS	MAXIMUM RPM	ARBOR(S)
LM0438	4-3/8"	1.0mm	13,200	7/8", 20mm

## SONIC

### HIGH-QUALITY WET CUTTING BLADE FOR TILE



- Best Valued Wet Cutting Tile Blade
- Recommended for Ceramic and Marble Tile
- Formulated for Chip-Free Cutting and Long Life
- High-Quality, General-Purpose Tile Blade
- Wet Use Only (Except for 4-1/2" and 5" Blades Can Be Used Wet or Dry)

PART NO.	SIZE	THICKNESS	MAXIMUM RPM	ARBOR(S)	DEPTH
TS04AL	4"	1.4mm	14,500	20mm, 5/8"	1"
TS05AL	4-1/2"	1.4mm	13,200	7/8", 20mm	1-1/4"
TS06AL	6"	1.4mm	10,100	5/8"	1-3/4"
TS07AL	7"	1.6mm	8,400	5/8"	2-1/4"
TS08AL	8"	1.6mm	7,400	5/8"	2-3/4"
TS10AL	10"	2.0mm	5,900	5/8"	3-3/4"
TS12AL	12"	2.0mm	6,200	1"	3-5/8"
TS14AL	14"	2.0mm	4,365	1"	4-5/8"



## VETRO

## ULTIMATE WET BLADE FOR GLASS TILES



- Best Wet Cutting Glass Blade on the Market
- Designed for Chip-Free Cutting
- Tile Installer's Choice for Glass Tile
- Chip-Free Cutting on Most Demanding Applications
- Wet Use Only

PART NO.	SIZE	THICKNESS	MAXIMUM RPM	ARBOR(S)
WG0438	4-3/8"	1.0mm	13,200	7/8", 20mm
WG0700	7"	1.6mm	8,400	5/8"
WG0800	8"	1.6mm	7,400	5/8"
WG1000	10"	1.6mm	5,900	5/8"

## VETRO for PRS

## ULTIMATE GLASS BLADE FOR PORTABLE RAIL SAW



- Wet Use Only
- Designed for Chip-Free Cutting
- Tile Installer's Choice for Glass Tile
- Best Wet Cutting Glass Blade for Rail Saw on the Market
- Chip-Free Cutting on Most Demanding Applications

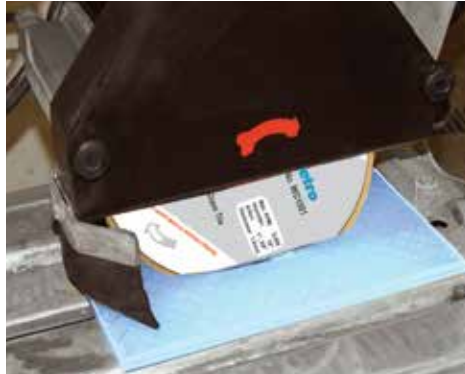

PART NO.	SIZE	THICKNESS	MAXIMUM RPM	ARBOR(S)
WG1001	10"	1.6mm	5,900	1", 5/8"

## PORCELLANA

## ULTIMATE WET BLADE FOR PORCELAIN TILES



- 3/8" (10mm) Tall Diamond Layer for Long Life
- Tile Installer's Choice for Chip Free Wet Cutting
- Recommended for Granite, Marble, Porcelain, Engineered Stone, Travertine and Ceramic Tiles
- Best Wet Cutting Tile Blade on the Market
- Hybrid Wet Saw Blade for All Tiles
- Wet Use Only

PART NO.	SIZE	THICKNESS	MAXIMUM RPM	ARBOR(S)
PT04A+	4-3/8"	1.4mm	13,200	7/8", 20mm
PT05S	5"	1.4mm	12,200	7/8"
PT07A+	7"	1.6mm	8,400	5/8"
PT08A+	8"	1.6mm	7,400	5/8"
PT10A+	10"	1.6mm	5,900	5/8"

## PORCELLANA for PRS

## ULTIMATE BLADE FOR PORTABLE RAIL SAWS



- 3/8" (10mm) Tall Diamond Layer for Long Life
- Tile Installer's Choice for Chip-Free Wet Cutting
- Recommended for Granite, Marble, Porcelain, Engineered Stone, Travertine and Ceramic Tiles
- Best Wet Cutting Tile Blade for Rail Saw on the Market
- Hybrid Wet Saw Blade for All Tiles
- Wet Use Only



PART NO.	SIZE	THICKNESS	MAXIMUM RPM	ARBOR(S)
PT0801	8"	1.6mm	7,400	1", 7/8", 5/8"
PT1001	10"	1.6mm	5,900	1", 5/8"

## Q-CUT

### THE ULTIMATE WET BLADE FOR QUARTZITE/GRANITE TILE



- Formulated To Cut Hard Tiles Such As Quartzite/ Granite
- Tile Installer's Choice for Stone Tile
- Designed for Fast, Precision Chip-Free Cutting
- Perfect for 2cm Porcelain Paver Tile
- Wet Use Only (*Except for 4-1/2" and 5" Blades Can Be Used Wet or Dry*)



**TILE  
INSTALLER'S  
CHOICE FOR  
STONE TILE**



PART NO.	SIZE	THICKNESS	MAXIMUM RPM	ARBOR(S)
QZ4578	4-1/2"	1.6mm	13,200	7/8", 20mm
QZ0578	5"	1.6mm	12,200	7/8"
QZ0658	6"	1.4mm	10,100	7/8", 5/8", ⌀
QZ0758	7"	1.6mm	8,400	5/8"
QZ0858	8"	1.6mm	7,400	5/8"
QZ1058	10"	2.0mm	5,900	5/8"

## CORDLESS SAW BLADE

## WET/DRY SAW BLADE FOR CERAMIC TILE



- Can Be Used Wet or Dry
- Ideal for Switch Box Cut-Out and Trimming
- Perfect for Ceramic and Stone Tiles
- Specially Designed for Cordless Saw
- Chip-Free Wet/Dry Cutting for Tile
- Cordless Saw Blade for Tile

PART NO.	SIZE	THICKNESS	MAXIMUM RPM	ARBOR(S)
BT03AL	3-3/8"	1.2mm	1,500	15mm



## CORDLESS SAW BLADE

## WET/DRY SAW BLADE FOR GLASS



- Wet Use Only
- Ideal for Switch Box Cut-Out and Trimming
- Perfect for Mirror, Glass and Glass Tile
- Specially Designed for Cordless Saw
- Chip-Free Wet Cutting for Glass Tile and Sheet Glass
- Cordless Saw Blade for Glass

PART NO.	SIZE	THICKNESS	MAXIMUM RPM	ARBOR(S)
BG03AL	3-3/8"	0.9mm	1,500	15mm



# FLUSH CUTTING BLADE

## VORTEX

### INTRICATE & FLUSH CUTTING BLADE FOR GRANITE



- Requires Quad Drive to fit High-Speed Angle Grinder
- Perfect for Granite and Engineered Stone
- Specially Designed for Flush Cutting
- Stone Fabricator's Choice
- Chip-Free Cutting on Most Demanding Applications
- Side Protection Segments Help Cutting Straight



PART NO.	SIZE	THICKNESS	MAXIMUM RPM	ARBOR(S)	THREADS
FCD40AH	4"	2.5mm	14,500	20mm Quad Drive	
FCD50AH	5"	2.5mm	12,200	20mm Quad Drive	
AAH-20		Aluminum Adapter		20mm	5/8"-11
BAH-5/8		Brass Adapter		20mm	5/8"-11

## VORTEX

### INTRICATE & FLUSH CUTTING BLADE FOR MARBLE



- Requires Quad Drive to fit High-Speed Angle Grinder
- Specially Designed for Marble and Lime Stone
- Specially Designed for Flush Cutting
- Stone Fabricator's Choice
- Chip-Free Cutting on Most Demanding Application



PART NO.	SIZE	THICKNESS	MAXIMUM RPM	ARBOR(S)	THREADS
FCM50AH	5"	1.6mm	12,200	20mm Quad Drive	
AAH-20		Aluminum Adapter		20mm	5/8"-11
BAH-5/8		Brass Adapter		20mm	5/8"-11

**CONTOUR**

**CURVE CUTTING BLADE FOR PORCELAIN/CRYST. GLASS**

# CONTOUR

## FOR PORCELAIN

Curve Cutting on Porcelain, Crystallized Glass and Sintered Slabs



- Designed Specifically for Cutting Porcelain and Sintered Slabs
- Fits On Wet/Dry Stone Cutters
- Cuts Curved Areas Cleanly, Accurately and Safely While Allowing A Wider Kerf
- Direct Sintered Diamond Segments On Steel Core Prevents Undercutting
- Can Be Used Either Wet or Dry

PART NO.	SIZE	THICKNESS	MAXIMUM RPM	ARBOR(S)	DEPTH OF CUT
CCP004	4"	4.0mm	14,500	7/8"	3/4"
CCP045	4-1/2"	4.0mm	13,200	7/8"	3/4"
CCP005	5"	4.0mm	12,200	7/8"	1-1/4"



## CONTOUR

## CURVE CUTTING BLADE FOR GRANITE AND ENG. STONE



- Specifically Developed for Cutting Granite Sinkholes
- Best Seller for Sinkhole Application
- Works Very Well On Engineered Stone, Quartzite and Harder Types of Natural Stone
- Cuts Curved Areas Cleanly, Accurately and Safely While Allowing A Wider Kerf
- Fits on Wet/Dry Stone Cutters
- Direct Sintered Diamond Segments On Steel Core Prevents Undercutting
- Fits On CNC Router with Cutting Head
- Can Be Used Either Wet or Dry



PART NO.	SIZE	THICKNESS	MAXIMUM RPM	ARBOR(S)	DEPTH OF CUT
CCB004	4"	4.0mm	14,500	7/8"	3/4"
CCB045	4-1/2"	4.0mm	13,200	7/8"	3/4"
CCB005	5"	4.0mm	12,200	7/8"	1-1/4"
CCB006	6"	4.0mm	10,100	7/8"	1-5/8"



## HOT-ROD

## CHANNEL CUTTING BLADE FOR GRANITE



- Perfect for Channel Cutting with Wet/Dry Stone Cutters
- Great for Grout Removal with Ecocutter
- Fabricator's Choice for Rodding on Granite
- Reliable Proven Performer
- Can Be Used Wet or Dry

### ROD SIZE



### GROUT WIDTH



PART NO.	SIZE	THICKNESS	MAXIMUM RPM	ARBOR(S)	RECOMENDED FOR
HT03A+	3"	4.2mm	14,500	7/8", 20mm	1/8" Rod
HQ03A+	3"	5.5mm	14,500	7/8", 20mm	3/16" Rod
HR03A+	3"	7.0mm	14,500	7/8", 20mm	1/4" Rod
HW03A+	3"	11.5mm	14,500	7/8"	3/8" Threaded Rod
HS03A+*	3"	4.75mm	14,500	7/8", 20mm	1/8" Rod
HM03A+*	3"	6.5mm	14,500	7/8", 20mm	1/4" Rod
HT04A+	4"	4.2mm	14,500	7/8", 20mm	1/8" Rod
HR04A+	4"	7.0mm	14,500	7/8", 20mm	1/4" Rod

\*Marble

# CHANNEL CUTTING BLADE

## GROOVE CUTTER

## WET GROOVE CUTTING BLADE FOR JOINT SEAMING



- Designed To Cut Flawless Grooves for Joint Seaming
- Perfect for Granite and Engineered Stone
- Specially Designed for 1-1/4" (3cm) Countertop
- Creates The Strongest Joint Seams
- Consistent Performance with Ease of Operation

PART NO.	THICKNESS	MAXIMUM RPM	THREADS	RECOMMENDED FOR	FOR USE ON
GCW258	4.2mm	14,500	5/8"-11	3/4" Slab	Granite
GCW358	7.5mm	14,500	5/8"-11	1-1/4" Slab	Granite
MCW258	4.6mm	14,500	5/8"-11	3/4" Slab	Marble
GCW214	4.2mm	14,500	M14-2	3/4" Slab	Granite
GCW314	7.5mm	14,500	M14-2	1-1/4" Slab	Granite
MCW214	4.6mm	14,500	M14-2	3/4" Slab	Marble
PFBNG01	Fits Up to 4cm Profilers			Nylon Guide	
PFBNG02	Fits All Sizes of Profilers			Nylon Guide	

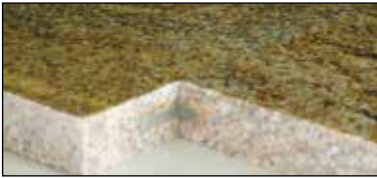

## MARBLE PROFILE WHEEL

## WET CUTTING MARBLE PROFILE WHEEL



- Cut and Profile Marble Tile in One Pass
- Fits Tub and Tile Saws
- Ideal Tool for Cutting and Profiling Tile Baseboards
- High-Quality Diamonds and Matrix Best Suited for Wet Cutting Marble and Agglomerated Marble Tile
- Save Time, Money and Reduce Waste

PART NO.	SIZE	MAXIMUM RPM	ARBOR(S)
DPM638	6"	6,000	5/8"

## BLADEMASTER

## HIGH-SPEED DIAMOND BLADE FOR DEMOLITION / CONCRETE



- High-Quality Laser-Welded Segmented Blades for High-Speed Demolition Saws
- Slices Through Materials with Ease
- Works On Concrete with Re-Bar, Steel, Stone, Metal, Wood, Glass and Rubberized Materials
- Fits Masonry Saws & Road Cutters
- Can Be Used Wet or Dry
- Available in 12", 14" and 16" Diameters with Pin Hole

PART NO.	SIZE	THICKNESS	MAXIMUM RPM	ARBOR(S)
BML1214	12"	2.9mm	6,200	1" w/pin hole
BML1414	14"	3.0mm	5,360	1" w/pin hole
BML1614	16"	3.1mm	4,700	1" w/pin hole

## RESCUE

## DEMOLITION BLADE CUTS IT ALL



- Slices Through Materials with Ease
- Works on Concrete with Re-Bar, Steel, Stone, Metal, Wood, Glass and Rubberized Materials
- Proven Winner for Firefighters, Police Officers and Construction Professionals
- Use on Gas-Powered Cut-Off Saws
- Available in 9", 12" and 14" Diameters

PART NO.	SIZE	THICKNESS	MAXIMUM RPM	ARBOR(S)
RB09A+	9"	2.8mm	8,300	7/8"
RB12A+	12"	3.0mm	6,200	1", 7/8", 20mm w/Pin Hole
RB14A+	14"	3.2mm	5,360	1", 7/8", 20mm w/Pin Hole
DR14A+	14"	3.4mm	5,360	1", 7/8", 20mm



## QUAD ADAPTERS



- Designed for Flush Cutting Blades with Four Mounting Holes
- Made Of Durable High-Quality Brass or Aluminum
- Easily Mounted To Any Quad Drive Blade
- Available in Various Thread Sizes

PART NO.	TYPE	ARBOR(S)	THREADS
AAH-7/8	Aluminum	7/8"	5/8"-11
AAH-20	Aluminum	20mm	5/8"-11
BAH-5/8	Brass	20mm	5/8"-11

## FLANGE ADAPTERS



- Designed for Blades That Are Eight Inches or Larger with Eight Mounting Holes
- Made Of Durable High-Quality Steel
- Easily Mounted To Any Large Flush Cutting Blade
- Available in 5/8"-11 and M14-2 Thread Sizes

PART NO.	TYPE	THREADS
FAH-5/8	Adapter	5/8"-11
FAH-M14	Adapter	M14-2

## SPIKE RULER



- Designed As A Precision Ruler That Will Not Move On Thin Porcelain Tiles or Panels with Texturized Surfaces
- Secures Ruler To The Material
- Convenient and Easy To Use
- Made Of Aluminum with A Wood Base

PART NO.	SIZE
SPR100	3'4" (1m)

## DRESSING STICK



- Designed To Expose New Cutting Surfaces or Re-Open Glazed Diamond Blades and Grinding Wheels
- Removes Sinter Bond From Cutting Edge
- Can Be Used To Ease Sharp Corners
- Bond Type: Silicon Carbide

PART NO.	SIZE	GRIT
290006	8" x 1.5" x 1.5"	60

## GUIDE RAILS

**CREATES STRAIGHT CUTS EVERYTIME**



- Guide Rails are High-Quality Straight Edges Constructed of Sturdy Cast Aluminum
- Perform Cuts That Are Straight and True, Time After Time
- Available in Three (3) Lengths and May Be Purchased Individually or As A Kit
- Works Great When Used with A Carriage Assembly
- Must-Have Accessory for Wet/Dry Stone Cutters and Beveling Auxiliary Base
- Complete System Makes Precision Cutting Fast and Easy
- Perfect for Miter Cutting for Laminated Waterfall Edge

PART NO.	SIZE	FOR USE WITH	DESCRIPTION
ASC-GR04	4' (1.2m)		Guide Rail with 2 Clamps
ASC-GR07	7' (2.1m)		Guide Rail with 2 Clamps
ASC-GR012	12' (3.6m)		Guide Rail (2-6' pcs) with 2 Clamps, Connector & 4 Screws
ASC-GRKIT	Set		Guide Rail Bundle (3 Rails (4', 7', 12'), 6 Clamps, Connector & 4 Screws)
GR-AGCT	12" (0.3m)		Guide Rail Connector w/4 Screws (M8x20) for 12' Rails
ECO-CAM		ECC-125	Ecocutter Carriage Assembly
ASC-5CSM	5"	ESC-125	Guide Rail Carriage Assembly
ASC-6CSM	6"	PSC-150	Guide Rail Carriage Assembly
BAB-CASM		BAB1590	Carriage Assembly for Beveling Base

**ASC-6CSM**



**ASC-5CSM**



**BAB-CASM**



## EZ THIN TILE CUTTERS

## FAST AND ACCURATE CUTTING TOOLS

### EZ SLIMLINE OIL CUTTER



HIGH-PRECISION CUTTER

- Tungsten-Carbide wheel on a Tungsten-Carbide axle provides the cleanest score and a long, wobble-free life
- Shaped and tapered clear plastic handle with profiled grip is ideal for tile contractors, artists, and craftsmen

Part No. KOC305B



### EZ THIN PANEL T-CUTTER

SMOOTH EASY CUTS



- The smooth-running, fast-cutting, easy-to-use manual glass cutter for sheet glass or thin panel materials
- Highly adaptable and quickly adjusts for odd-sized pieces as well as low maintenance and long service life
  - Makes perfect parallel cut to the guide edge with little effort



Available in 24" and 60"

Part No. KEC-600  
Part No. KEC-1500

### EZ GLASS RUNNING PLIERS



CLEAN BREAKS EVERYTIME

- Lightweight aluminum plier can be used on various thicknesses of glass from 5mm to 12mm
- Off-set handle provides clean and quick breaks
- The high-density plastic jaws will not chip or mark your glass



Part No. KOC512P



Unique Oil-Feed System Controls Oil Flow To Suit The Individual Needs



PART NO.	RECOMMENDED FOR	DESCRIPTION
KEC-600	Up to 24"	EZ Thin Panel T-Cutter 24"
KEC-1500	Up to 60"	EZ Thin Panel T-Cutter 60"
KOC305B	Straight Cuts	EZ Slimline Oil Cutter
KOC512P	Thickness 5mm to 12mm	EZ Glass Running Plier
5480-1700		EZ Thin Cutter Starter Kit (inc. 24" T-Cutter, Slimline Oil Cutter, Plier & Oil)
KOC1000	EZ Tile Cutter Lubricant	EZ Cutter Oil - 8oz. (237ml)

## PROFILER B-SERIES

## CREATES PERFECT DEMI-BULLNOSE EDGE



- Use On Granite, Engineered Stone, Marble, Concrete, Crystallized Glass, Porcelain Slabs and Sintered Slabs
- Create A Perfect Demi-Bullnose/Roundover Edge Treatment
- Nylon Guide and Rotary Touchier Assures The Proper Depth Of Cut Is Achieved
- Equipped with A 5/8"-11 Female Thread and Internal Water Passage Holes
- Fits On All Popular Water-Fed Polishers



Demi-Bullnose



PART NO.	SIZE	MAXIMUM RPM	THREADS	SHAPE
PFB051	3/16" (0.5cm)	3,500	5/8"-11	Demi-Bullnose
PFB101	3/8" (1.0cm)	3,500	5/8"-11	Demi-Bullnose
PFB131	1/2" (1.3cm)	3,500	5/8"-11	Demi-Bullnose
PFB201	3/4" (2.0cm)	3,500	5/8"-11	Demi-Bullnose
PFBNG01	Fits up to 4cm Profilers		Nylon Guide	
PFBNG02	Fits All Sizes of Profilers		Nylon Guide	



**PROFILER V-SERIES**

**CREATES PERFECT BULLNOSE EDGE**

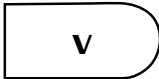

Full Bullnose

- Create A Perfect Bullnose/Roundover Edge Treatment
- Use On Granite, Engineered Stone, Marble, Limestone, Concrete, Crystallized Glass, Porcelain and Sintered Slabs
- Eliminate The Time-Consuming Calibration Process for Seamed Pieces
- Nylon Guide and Rotary Touchier Assures The Edges Are Uniform
- Equipped with A 5/8"-11 Female Thread and Internal Water Passage Holes
- Fits On All Popular Water-Fed Polishers

PART NO.	SIZE	MAXIMUM RPM	THREADS	SHAPE
PFV201	3/4" (2cm)	3,500	5/8"-11	Full Bullnose
PFV301	1-1/4" (3cm)	3,500	5/8"-11	Full Bullnose
PFV401	1-1/2" (4cm)	3,500	5/8"-11	Full Bullnose
PFV501	2" (5cm)	5,000	5/8"-11	Full Bullnose
PFV601	2-3/8" (6cm)	5,000	5/8"-11	Full Bullnose
PFBNG01	Fits Up To 4cm Profilers		Nylon Guide	
PFBNG02	Fits All Sizes of Profilers		Nylon Guide	

**PROFILER Z-SERIES**

**PERFECT 90-DEGREE EDGE GRINDING**

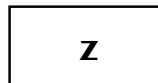

Straight Edge

- Vertical Grinding On All Types Of Materials
- Never Loses Shape for True Zero Tolerance
- Nylon Guide and Rotary Touchier Assures Uniformity
- Equipped with A 5/8"-11 Female Thread and Internal Water Passage Holes
- Fits On All Popular Water-Fed Polishers

PART NO.	SIZE	MAXIMUM RPM	THREADS	SHAPE
PFZ301	1-1/4" (3cm)	3,500	5/8"-11	Straight
PFZ401	1-1/2" (4cm)	3,500	5/8"-11	Straight
PFZ501	2" (5cm)	6,000	5/8"-11	Straight
PFBNG01	Fits up to 4cm Profilers		Nylon Guide	
PFBNG02	Fits All Sizes of Profilers		Nylon Guide	

## SPIKE DISC

## COATING REMOVAL MADE EASY



- Designed for Thick Coating Removal of Epoxy, Urethane, Glue and Adhesives
- Unique Open-Mesh Layout Reduces Clogging and Heat Build-Up
- Optimized Diamond Grits Provide A Consistent Performance
- Sandwiched-Rubber Cushioned Light-Weight Body Reduces Noise and Vibration
- Each Diamond Bead Has Multiple Diamond Grits To Maintain A Sharp Cutting Capability for A Long Time
- Can Be Used On Wood, Glass Fiber Reinforced Polymer and Carbon Fiber Reinforced Polymer.
- Available in 4-1/2", 5" and 7" with 7/8" Arbor or with 5/8"-11 Zinc Hub and A Square Arbor for Spring Load Systems
- Combine with The Ecoguard G for A Virtually Dust-Free Solution

PART NO.	SIZE	MAXIMUM RPM	ARBOR(S)	GRIT
VCS4535	4-1/2"	13,200	7/8"	35
VCS453H	4-1/2"	13,200	5/8"-11	35
VCS4550	4-1/2"	13,200	7/8"	50
VCS455H	4-1/2"	13,200	5/8"-11	50
VCS5035	5"	13,200	7/8"	35
VCS503H	5"	12,200	5/8"-11	35
VCS503Q	5"	12,200	Sq Arbor	35
VCS5050	5"	12,200	7/8"	50
VCS505H	5"	12,200	5/8"-11	50
VCS7035	7"	8,400	7/8"	35
VCS703H	7"	8,400	5/8"-11	35
VCS7050	7"	8,400	7/8"	50
VCS705H	7"	8,400	5/8"-11	50



close-up of diamonds



sandwich construction

## VEXTRA FLAT DISC

## GENERAL PURPOSE FLAT GRINDING DISC



- Can Be Used On Natural Stones, Engineered Stone/ Quartz Surface, Wood and Rubber
- Optimized Diamond Grits for Consistent Performance
- Sandwich Construction Reduces Noise and Vibration
- Available in 4-1/2", 5" and 7" with 7/8" Arbor or with 5/8"-11 Zinc Hub
- Works Well When Eliminating Epoxy, Glues and Adhesives

PART NO.	SIZE	MAXIMUM RPM	ARBOR(S)	GRIT
VDD4535	4-1/2"	13,200	7/8"	35
VDD453H	4-1/2"	13,200	5/8"-11	35
VDD4550	4-1/2"	13,200	7/8"	50
VDD455H	4-1/2"	13,200	5/8"-11	50
VDD4580	4-1/2"	13,200	7/8"	80
VDD458H	4-1/2"	13,200	5/8"-11	80
VDD5035	5"	12,200	7/8"	35
VDD503H	5"	12,200	5/8"-11	35
VDD5050	5"	12,200	7/8"	50
VDD505H	5"	12,200	5/8"-11	50
VDD5080	5"	12,200	7/8"	80
VDD508H	5"	12,200	5/8"-11	80
VDD7035	7"	8,400	7/8"	35
VDD703H	7"	8,400	5/8"-11	35
VDD7050	7"	8,400	7/8"	50
VDD705H	7"	8,400	5/8"-11	50
VDD7080	7"	8,400	7/8"	80
VDD708H	7"	8,400	5/8"-11	80



open-mesh

sandwich construction

## VEXCEL RIGID DISC

## GENERAL PURPOSE RIGID GRINDING DISC



- Designed for Heavy-Duty Material Removal Applications
- Robust Diamond Grits for Maximum Performance
- Fluoric Rubber Backing To Reduce Noise and Vibration
- Very Aggressive and A Long Life
- Use on Granite, Engineered Stone, Quartzite, Marble, Concrete and Sintered Slabs

PART NO.	SIZE	MAXIMUM RPM	ARBOR(S)	GRIT
VDR4525	4-1/2"	13,200	7/8"	25
VDR452H	4-1/2"	13,200	5/8"-11	25
VDR4535	4-1/2"	13,200	7/8"	35
VDR453H	4-1/2"	13,200	5/8"-11	35
VDR4550	4-1/2"	13,200	7/8"	50
VDR455H	4-1/2"	13,200	5/8"-11	50
VDR4580	4-1/2"	13,200	7/8"	80
VDR458H	4-1/2"	13,200	5/8"-11	80
VDR5025	5"	12,200	7/8"	25
VDR502H	5"	12,200	5/8"-11	25
VDR5035	5"	12,200	7/8"	35
VDR503H	5"	12,200	5/8"-11	35
VDR5050	5"	12,200	7/8"	50
VDR505H	5"	12,200	5/8"-11	50
VDR5080	5"	12,200	7/8"	80
VDR508H	5"	12,200	5/8"-11	80
VDR7025	7"	8,400	7/8"	25
VDR702H	7"	8,400	5/8"-11	25
VDR7035	7"	8,400	7/8"	35
VDR703H	7"	8,400	5/8"-11	35
VDR7050	7"	8,400	7/8"	50
VDR705H	7"	8,400	5/8"-11	50
VDR7080	7"	8,400	7/8"	80
VDR708H	7"	8,400	5/8"-11	80



sandwich construction



open-mesh

## DW STYLE

**DESIGNED FOR NATURAL & ENGINEERED STONE**



- Aggressive Grinding Wheel Specially Formulated for Natural Stone Products
- Performs Exceptionally Well On Most Granites and Harder Materials
- Turbo Design Provides Fast Stock Removal
- Premium Choice for Any Grinding, Shaping or Beveling Work
- Fabricators Love Its Aggressiveness and Endurance
- Available in 4" and 6" Diameters
- Coarse and Medium Grits Available
- Can Be Used Wet or Dry

PART NO.	SIZE	MAXIMUM RPM	THREADS	GRIT
DW4C11	4"	14,500	5/8"-11	Coarse
DW4M11	4"	14,500	5/8"-11	Medium
DW6C11	6"	10,100	5/8"-11	Coarse
DW6M11	6"	10,100	5/8"-11	Medium

## DS STYLE

**DESIGNED FOR NATURAL & ENGINEERED STONE**



- Perfect for Lightweight Grinding and Shaping Work
- Works Well On Marbles, Granites and Engineered Stones
- Exclusive "No Bounce" Construction Reduces Operator Fatigue and Improves Control
- Fits On Most Common Angle Grinders and Wet Polishers
- Can Be Used Wet or Dry At Low or High-Speeds
- Versatile and Long Lasting
- Great for Shaping Delicate Edges

PART NO.	SIZE	MAXIMUM RPM	THREADS	GRIT
DS4C11	4"	14,500	5/8"-11	Coarse

## VFLEX SANDING DISC

## GENERAL PURPOSE FLEXIBLE SANDING DISC



- Perfect for paint, coating, oxide and rust removal, grinding burr and chamfering on the edge of steel, stainless steel and contoured surfaces
- For use on: Stone, Ceramic & Composite Materials
- Flexible Sandwich Construction Reduces Noise and Vibration
- Ideal for Shaping Natural/Engineered Stone and Glass
- Available in 5" and 7" with 7/8" arbor or with 5/8"-11 zinc hub

PART NO.	SIZE	MAX RPM	ARBOR(S)	GRIT
VDF5035	5"	5,000	7/8"	35
VDF503H	5"	5,000	5/8"-11	35
VDF5050	5"	5,000	7/8"	50
VDF505H	5"	5,000	5/8"-11	50
VDF5080	5"	5,000	7/8"	80
VDF508H	5"	5,000	5/8"-11	80
VDF7035	7"	5,000	7/8"	35
VDF703H	7"	5,000	5/8"-11	35
VDF7050	7"	5,000	7/8"	50
VDF705H	7"	5,000	5/8"-11	50
VDF7080	7"	5,000	7/8"	80
VDF708H	7"	5,000	5/8"-11	80



flexible sandwich construction

## SANDPAPER

## CONCRETE AND MARBLE POLISHING



- Waterproof Hook and Loop Backed Silicon Carbide Abrasive
- Use On Marbles and Softer Types of Natural Stone
- Can Also Be Used To Polish Glass, Metal and Wood
- Very Adaptable To Onsite Work and Easy To Use
- Resists Clogging When Used Wet
- Can Be Used Wet or Dry



HOOK AND LOOP		4"	5"
GRIT	QUANTITY	PART NO.	PART NO.
80	50	MP40080	MP50080
120	50	MP40120	MP50120
240	50	MP40240	MP50240
320	50	MP40320	MP50320
400	50	MP40400	MP50400
500	50	MP40500	MP50500
600	50	MP40600	MP50600
Assortment	50	MP40KIT	MP50KIT



# SHAPING/HONING DISCS



Alpha® Ceramica is a three-part system for polishing granite, hard marble and porcelain. Utilizing the best grade industrial diamonds and the best bond materials, Alpha® Ceramica is sure to provide the best possible finish on your polished stone. Alpha® Ceramica EX augments the Ceramica line allowing the fabricator to polish a variety of different materials such as engineered stone, quartz surfaces, marble, porcelain and granite.

part 1

### Ceramica Vitrified and Ceramica Metal

Long lasting and aggressive design.  
Rigid or flexible depending upon application requirements.  
Use for light shaping work, smoothing and preparing for the polishing process.

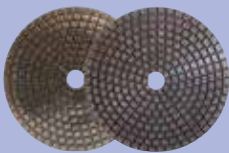
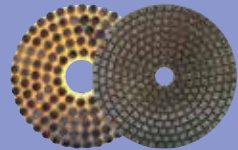

### Ceramica Resin and Ceramica EX

Fine grade diamonds are heat sintered in a hard resin bond within a flexible matrix.  
Each grit covers the previous grit, and through the process closes the pores for a natural polish.  
After the last grit, a solid natural polish is achieved.

part 2

part 3

### Ceramica Buff

Super fine abrasive disc that brings out a deep glossy reflection with a mirror finish.  
Use in place of messy polishing powders and dangerous chemicals for final polishing.

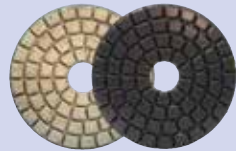

APPLICATION	VITRIFIED	RESIN	METAL
Ogee Edge	NR	R	HR
Undermount Sink Hole	NR	R	HR
Inside Corners	NR	R	HR
Bullnose	HR	R	R

(Applicable up to 300 Grit)

PERFORMANCE	VITRIFIED	RESIN	METAL
Durability	HR	R	HR
Flexibility	R	HR	HR
Cutting	HR	R	HR

POLISHING AREAS	VITRIFIED	RESIN	METAL
Concave	R	HR	HR
Convex	HR	R	R
Flat	R	NR	HR

Alpha® Ceramica is designed for a variety of applications and can be used in the polishing shop at the job site. A long time standard in the fabrication area, there are no other systems with the same capability for a deep gloss finish.

KEY: HR = Highly Recommended

R = Recommended

NR = Not Recommended

## CERAMICA VITRIFIED

## PREPARATION STAGE FOR WET GRANITE POLISHING



- Designed To Handle The Hard Job of Removing Saw and Grinding Marks
- Ideal for The Bullnose or Profiled Edge
- Fabricators Love The Aggressiveness, Ease of Use and Long Life
- Excellent Results On A Consistent Basis
- Available in Grits of 60, 150 and 300
- Cost-Effective Investment



HOOK AND LOOP		3"	4"	5"
GRIT	COLOR	PART NO.	PART NO.	PART NO.
60	Blue	GP30060V	GP40060V	GP50060V
150	Yellow	GP30150V	GP40150V	GP50150V
300	Orange	GP30300V	GP40300V	GP50300V

## CERAMICA METAL

## PREPARATION STAGE FOR WET GRANITE POLISHING



- Best Combination with Aggressive Cutting Performance and Flexibility
- Designed for Polishing Harder Types of Natural Stone
- Discs Have The Hardness of A Metal Bond Diamond in A Flexible Resin Bond Disc
- Superior Aggressiveness Compared To Standard Resin Bond Discs
- Polishes in Tight, Difficult To Reach Areas Such As Internal Corners and Inside Rim of Sink Holes
- Consistent Performance and A Long Life
- Available in Grits of 60, 150 and 300



HOOK AND LOOP		3"	4"
GRIT	COLOR	PART NO.	PART NO.
60	Blue	FD30060M	FD40060M
150	Yellow	FD30150M	FD40150M
300	Orange	FD30300M	FD40300M

## CERAMICA RESIN

## ULTIMATE POLISHING PADS FOR GRANITE

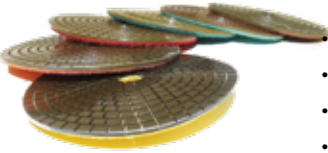

- High-Performance Discs Provide The Best Possible Polish
- Extremely Flexible with Consistent Performance
- Best in The Industry and Very Cost-Effective
- Designed for Wet Granite Hand Polishing
- Fabricators Achieve Excellent Results Consistently
- Works Extremely Well in Tight Curved Areas Such As Inside Sinkholes
- Available in 3", 4" and 5" Size Discs

HOOK AND LOOP		3"	4"	5"
GRIT	COLOR	PART NO.	PART NO.	PART NO.
150	Yellow	GP30150R	GP40150R	GP50150R
300	Orange	GP30300R	GP40300R	GP50300R
500	Red	GP30500R	GP40500R	GP50500R
1000	Dark Green	GP31000R	GP41000R	GP51000R
2000	Light Green	GP32000R	GP42000R	GP52000R
3000	Brown	GP33000R	GP43000R	GP53000R

## CERAMICA BUFF

## ULTIMATE WET GRANITE FINAL POLISHING

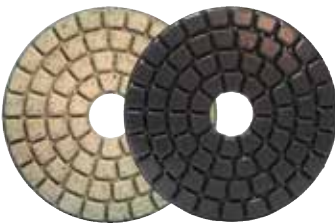

- Produces A Superior Glossy Finish
- Available in Black for Dark Stones and White for Light Colored Stones
- Small Amount of Water Required
- Consistent Performer for Professional Quality
- Hook & Loop Backed
- Use On Popular Hand-Held Wet Polishers
- Available in 3", 4" and 5"
- Favorite of Fabricators, Monumentalists and Tile Contractors

HOOK AND LOOP		3"	4"	5"
GRIT	COLOR	PART NO.	PART NO.	PART NO.
BUFF	Black	GP3BLACK	GP4BLACK	GP5BLACK
BUFF	White	GP3WHITE	GP4WHITE	GP5WHITE

## CERAMICA EX

## WET POLISHING FOR ALL STONES



- Produces A High-Quality Shine
- Polishes On All Materials
- Ideal for Polishing Inside Corners and A Tight Radius
- Works Very Well On Tough Materials Including Tough To Polish Black and Green Marbles
- Extremely Flexible

HOOK AND LOOP		3"	4"	5"
GRIT	COLOR	PART NO.	PART NO.	PART NO.
200	Yellow	EX30200R	EX40200R	EX50200R
500	Red	EX30500R	EX40500R	EX50500R
1000	Dark Green	EX31000R	EX41000R	EX51000R
2000	Light Green	EX32000R	EX42000R	EX52000R
3000	Brown	EX33000R	EX43000R	EX53000R
ALL	Assortment (1 each)	—	EX40KIT	—

## CERAMICA TF

## FOR TEXTURED FINISH



- Create Textured Finishes On Engineered Stone/ Quartz Surfaces
- Extremely Flexible Disc Reaches Tight Corners Comfortably
- Hook & Loop Backed for Quick Grit Changes
- Use On Popular Hand-Held Wet Polishers
- Use with Undersized Backer Pads for Internal Corners and Sink Rims



PART NO.	SIZE	TYPE	GRIT	COLOR
TFR4000	4"	Hook & Loop	Pos. 0	Orange
TFR4001	4"	Hook & Loop	Pos. 1	Red
TFR4002	4"	Hook & Loop	Pos. 2	Dark Green
TFR4003	4"	Hook & Loop	Pos. 3	Light Green
TF40KIT	4"	Hook & Loop	1 each	Assortment

## KIRARA PADS

## EASY THREE-STEP MAINTENANCE SYSTEM

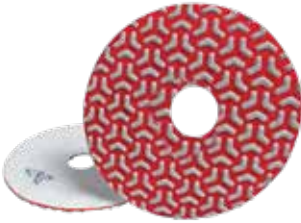

- Restore The Polish Of Marble, Limestone & Concrete Surfaces
- Great For Difficult To Polish Marble and Limestone, Such As Nero Maquina (Black Marble)
- Fast, Consistent, High-Quality Results
- Easy 3-Step Maintenance System
- Minimal Water Needed When Used Wet
- Can Be Used On A Typical Floor Buffers with 175 RPM or 300 RPM

PART NO.	SIZE	MAX RPM	TYPE	RECOMMENDED FOR	GRIT	COLOR
KWD4001	4"	4,000	Hook & Loop	Marble/Limestone/Concrete	Pos 1	Red
KWD4002	4"	4,000	Hook & Loop	Marble/Limestone/Concrete	Pos 2	Light Green
KWD4003	4"	4,000	Hook & Loop	Marble/Limestone/Concrete	Pos 3	Blue

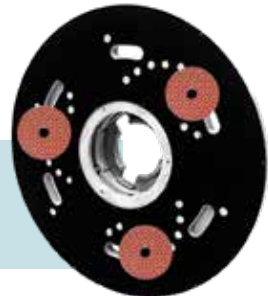
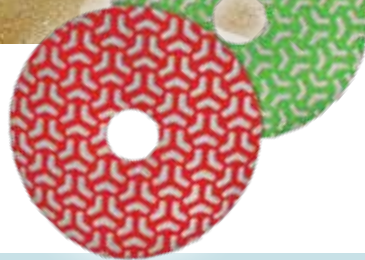
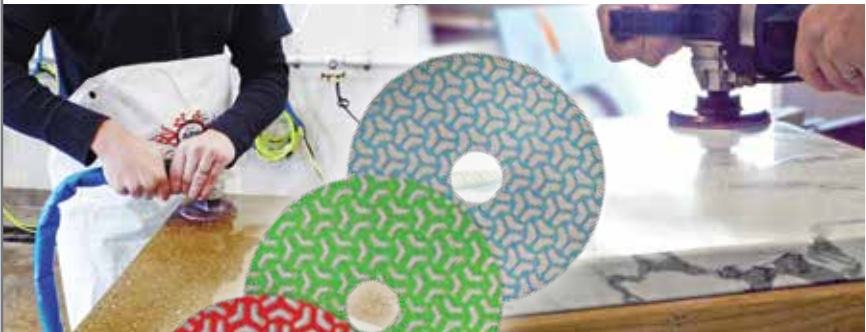

Can also be used on a **Driver Pad** for Floor Polishing!

## CERAMICA DRY

## DRY POLISHING FOR NATURAL STONES



- Dry Polish All Natural Stones and Cement-Based Composites
- For Use On Sanders and Polishers
- Thick Diamond Layer for Better Quality Results
- Hook & Loop Backed for Quick Grit Changes
- Use On Popular Hand-Held Wet Polishers



HOOK AND LOOP		4"	5"
GRIT	COLOR	PART NO.	PART NO.
60	Blue	CD40060R	CD50060R
200	Yellow	CD40200R	CD50200R
500	Red	CD40500R	CD50500R
1000	Dark Green	CD41000R	CD51000R
2000	Light Green	CD42000R	CD52000R
3000	Brown	CD43000R	CD53000R
ALL	Assortment (1 each)	CD40KIT	CD50KIT

## HAND PADS

## HAND POLISHING PADS

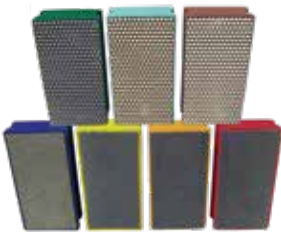

- Convenient, On-Site Polishing, On Materials
- Use On Glass, Ceramics, Marble, Granite, Porcelain, Concrete, Terrazzo and Quartz Surfaces
- Two Bond Types To Provide The Best Possible Finish
- Available in Electroplated and Resin Grits
- Can Be Used Wet or Dry



PART NO.	GRIT	COLOR	BOND TYPE
DHP0060	60	Blue	Electroplated
DHP0150	150	Yellow	Electroplated
DHP0300	300	Orange	Electroplated
DHP0500	500	Red	Electroplated
DHP1000	1000	Dark Green	Resin
DHP2000	2000	Light Green	Resin
DHP3000	3000	Brown	Resin
DHPKIT			Set of 7

## PVA VP

## VERSATILE, HIGH-SPEED DRY POLISHING SYSTEM



- Designed To Polish Softer Stones, Marble, Limestone, Travertine and Ceramic
- Can Be Used On Polishers, Sanders and Grinders At Any RPM
- Versatile, High-Speed and Long Lasting
- 4-1/2" Discs Do Not Clog
- Formulated with A Silicon Carbide Abrasive and A Polyvinyl Alcohol Bond
- Grits Range From Extra Coarse To Extra Fine
- Available with A 5/8"-11 Disposable Zinc Hub



VERSATILE, HIGH-SPEED DRY POLISHING SYSTEM FOR STONE & TILE

PART NO.	SIZE	GRIT	ARBOR	FINISH
SPVA45WH	4-1/2"	40	5/8"-11	Extra Coarse
SPVA45RH	4-1/2"	80	5/8"-11	Coarse
SPVA45BH	4-1/2"	220	5/8"-11	Medium
SPVA45GH	4-1/2"	400	5/8"-11	Fine
SPVA45YH	4-1/2"	600	5/8"-11	Extra Fine

PVA VP Polishing Disc with Hub





## PVA MS STYLE

## MARBLE EDGE POLISHING SYSTEM



- Best Polishing Solution for Glass Tile, Marble, Limestone and Travertine
- Ideal for Baseboard, Corner and Countertop Edge Applications
- Fast Working, Long Lasting At An Affordable Price
- 4" Discs Can Also Be Used for Paint Removal, As The Material Will Not Clog
- Works Well On Most Common High-Speed Grinders
- Grits Range From Extra Coarse To Extra Fine
- Available with a 5/8" Arbor
- Very Effective On Contours, Edges and Irregular Surfaces
- Polishes Stainless Steel to a mirror-like finish

PART NO.	SIZE	MAXIMUM RPM	ARBOR	GRIT	FINISH	QUANTITY
PVAMSW	4"	12,000	5/8"	40	Extra Coarse	10
PVAMSR	4"	12,000	5/8"	80	Coarse	10
PVAMSB	4"	12,000	5/8"	220	Medium	10
PVAMSG	4"	12,000	5/8"	400	Fine	10
PVAMSY	4"	12,000	5/8"	600	Extra Fine	10
PVAMSK	4"	12,000	5/8"	Assortment	All	10
SPVAMSW	4"	12,000	5/8"	40	Extra Coarse	1
SPVAMSR	4"	12,000	5/8"	80	Coarse	1
SPVAMSB	4"	12,000	5/8"	220	Medium	1
SPVAMSG	4"	12,000	5/8"	400	Fine	1
SPVAMSY	4"	12,000	5/8"	600	Extra Fine	1



10 pieces per box



ALSO AVAILABLE  
IN SINGLE PACK

## PVA QC STYLE

## MARBLE EDGE POLISHING SYSTEM



- Best Polishing Solution for Glass Tile, Marble, Limestone and Travertine
- Ideal for Baseboard, Corner and Countertop Edge Applications
- “Quick Change” Process Saves Time, Increases Productivity
- Works Well On Most Common Low Speed Polishing Tools
- 4” Discs Can Also Be Used for Paint Removal, As The Material Will Not Clog
- Fast Working, Long Lasting At An Affordable Price
- Grits Range From Extra Coarse To Extra Fine
- Polishes Stainless Steel To A Mirror-Like Finish
- Utilizes a Snail Lock Adapter (SFAT)

PART NO.	SIZE	MAXIMUM RPM	ARBOR	GRIT	FINISH	QUANTITY
PVAQCW	4"	4,000	QC	40	Extra Coarse	5
PVAQCR	4"	4,000	QC	80	Coarse	5
PVAQCB	4"	4,000	QC	220	Medium	5
PVAQCG	4"	4,000	QC	400	Fine	5
PVAQCY	4"	4,000	QC	600	Extra Fine	5
PVAQCK	4"	4,000	QC	Assortment	All	5
SPVAQCW	4"	4,000	QC	40	Extra Coarse	1
SPVAQCR	4"	4,000	QC	80	Coarse	1
SPVAQCB	4"	4,000	QC	220	Medium	1
SPVAQCG	4"	4,000	QC	400	Fine	1
SPVAQCY	4"	4,000	QC	600	Extra Fine	1
PVA-5/8	4"	4,000	5/8"-11	Snail Lock Adapter		



5 pieces per box



ALSO AVAILABLE  
IN SINGLE PACK

## TURBOSHINE

## POLISHING AND SCRATCH REMOVAL SYSTEM



**RIGID**

- Designed for Polishing Seamless Countertops and Scratch Removal for Natural and Engineered Stones
- Utilizes Dual Adapter System for Reduced Vibration
- Quick Disc Type and Grit Changes Reduces Downtime
- Provides The Best Results On Granite, Engineered Stone/Quartz Surfaces, and Difficult Marbles Such As Green and Black
- Final Polishing Wheel Achieves The Highest Possible Shine
- Unique #2000 Grit Disc Designed for Engineered Stone and Quartz Surfaces
- Works Great On Concrete Slabs



**BLACK BUFF**



**WHITE BUFF**



**SNAKE SKIN GENERATOR**



**GRINDING WHEEL**



**ADAPTER**

PART NO.	SIZE	MAX. RPM	TYPE	THREADS	GRIT	COLOR
TSR30100R	3"	4,000	Rigid	Dual Adapter System	100	Blue
TSR30200R	3"	4,000	Rigid	Dual Adapter System	200	Yellow
TSR30500R	3"	4,000	Rigid	Dual Adapter System	500	Red
TSR31000R	3"	4,000	Rigid	Dual Adapter System	1000	Dark Green
TSR32000R	3"	4,000	Rigid	Dual Adapter System	2000	Light Green
TSR33000R	3"	4,000	Rigid	Dual Adapter System	3000	Brown
TSR3BLACK	3"	4,000	Rigid	Dual Adapter System	Buff	Black
TSR3WHITE	3"	4,000	Rigid	Dual Adapter System	Buff	White
TSE32000R	3"	4,000	Flexible	Dual Adapter System	2000	Light Green
DAS35/8PD	3"	6,000	Adapter	5/8"-11		
DAS3M14PD	3"	6,000	Adapter	M14-2		
TSM30060M	3"	14,500	Grinding Wheel	5/8"-11	60	Blue
TSM30120M	3"	14,500	Grinding Wheel	5/8"-11	120	Yellow

## TURBOSHINE FOR CRYSTALLIZED GLASS

## POLISHING AND SCRATCH REMOVAL SYSTEM



- Designed To Polish Straight and Beveled Edges On Crystallized Glass and Other Vitreous Materials
- Utilizes Dual Adapter System for Reduced Vibration
- Great for Polishing Seamless Countertops and Scratch Removal On Pure White Crystallized Glass and Glass2 Slabs
- Quick Grit Changes Reduces Downtime
- Final Polishing Wheel Achieves The Highest Possible Shine



PART NO.	SIZE	MAX. RPM	TYPE	THREADS	GRIT	COLOR
TSG30200R	3"	4,000	Rigid	Dual Adapter System	200	Yellow
TSG30500R	3"	4,000	Rigid	Dual Adapter System	500	Red
TSG31000R	3"	4,000	Rigid	Dual Adapter System	1000	Dark Green
TSG32000R	3"	4,000	Rigid	Dual Adapter System	2000	Light Green
TSG3TSUYA	3"	4,000	Rigid	Dual Adapter System	Tsuya Final Polish	Black
DAS35/8PD	3"	6,000	Adapter	5/8"-11		
DAS3M14PD	3"	6,000	Adapter	M14-2		
TSM30060M	3"	14,500	Grinding Wheel	5/8"-11	60	Blue
TSM30120M	3"	14,500	Grinding Wheel	5/8"-11	120	Yellow

## ANTIQUE BRUSH WHEELS

## BRUSH WHEELS FOR TEXTURED FINISHES



- Create A Textured Finish On The Edge and Surface Of Engineered Stone/Quartz Surfaces
- Developed with TYNEX®, A Filament From Dupont, To Ensure Safety and Exceptional Performance
- Utilizes A Snail Lock Adapter (SFAT)
- Fits Most Popular Edge Polishing Machines, Hand-Held Sanders and Polishers
- Grits Sequence of #24, #36, #60, #120, #240 and #320
- Can Be Used On Other Stone Such As Granite

SNAIL LOCK			4"	5"
GRIT	BOND TYPE	MAXIMUM RPM	PART NO.	PART NO.
24	Resin	4,000	AB4024	AB5024
36	Resin	4,000	AB4036	AB5036
60	Resin	4,000	AB4060	AB5060
120	Resin	4,000	AB4120	AB5120
240	Resin	4,000	AB4240	AB5240
320	Resin	4,000	AB4320	AB5320
Snail Lock Adapter		4,000	PVA-5/8	
Snail Lock Adapter		2,000		SFAT-5/8

## FELT WHEELS

## FOR USE WITH POLISHING POWDERS



- Designed for Use with Polishing Powders, Pastes or Bars
- Very Durable - Holds Up To Acidic Compounds and Heat Generated During Final Polishing
- Hook and Loop Backed Buffing Wheels
- 1/4" Thick with The Perfect Degree Of Hardness Versus Softness
- Very Popular Material for The Final Buff Process with Fabricators and Monumentalists
- Can Be Used for Floor Polishing Applications

PART NO.	SIZE	TYPE
FW30250	3"	Hook & Loop
FW40250	4"	Hook & Loop
FW50250	5"	Hook & Loop

# BACKER PADS

## RIGID BACKER PADS

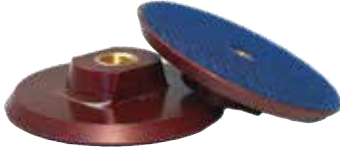

- High-Quality Backer Pad Is Super Rigid and Flat
- Eliminates The Wavy Finish When Polishing
- Hook and Loop Backed
- The Rigidness Of The Pad Enables Work in Small Areas Such As Corners or Staircases
- Accepts Polishing Pads, Sandpaper and Felt Wheels

PART NO.	SIZE	MAX RPM	THREAD
GP35/8RG	3"	6,000	5/8"-11
GP45/8RG	4"	6,000	5/8"-11
GP55/8RG	5"	6,000	5/8"-11
GP3M14RG	3"	6,000	M14
GP4M14RG	4"	6,000	M14
GP5M14RG	5"	6,000	M14
GP3M16RG	3"	6,000	M16
GP4M16RG	4"	6,000	M16
GP5M16RG	5"	6,000	M16
RGSPACER			Spacer

## FLEXIBLE BACKER PADS



- High-Quality Backer Pad Is Extremely Flexible
- Ideal for Tough Contours and Inside Curves
- Hook and Loop Backed
- Highly Resistant To The Rigors Of Daily Use Provides A Long Life
- Accepts Polishing Pads, Sandpaper and Felt Wheels

PART NO.	SIZE	MAX RPM	THREAD
GP25/8PD	2"	6,000	5/8"-11
GP35/8PD	3"	6,000	5/8"-11
GP45/8PD	4"	6,000	5/8"-11
GP55/8PD	5"	6,000	5/8"-11
GP3M14PD	3"	6,000	M14
GP4M14PD	4"	6,000	M14
GP5M14PD	5"	6,000	M14
GP3M16PD	3"	6,000	M16
GP4M16PD	4"	6,000	M16
GP5M16PD	5"	6,000	M16

## GV BACKER PADS



- High-Quality Backer Pad Is Rigid and Flat, But Provides Just The Right Amount Of Flexibility
- Ideal for Bullnosed Edges and Flat Surfaces.
- Hook and Loop Backed
- Accepts Polishing Pads, Sandpaper and Felt Wheels
- Fits On Makita® GV5000 & GV5010 Sanders

PART NO.	SIZE	MAXIMUM RPM	DESCRIPTION
GV4MPPD	4"	4,500	M8-1.25 Male
GV5MPPD	5"	4,500	M8-1.25 Male

# DUST COLLECTION COVERS

## ECOGUARD CD

### DUST AND WATER GUARD FOR CORE DRILLING



- Wet/Dry Cover for Drilling and Core Drilling Applications
- Fits Most Vacuum Dust Hoses
- Accepts up to 2-1/2" Core Bit
- Can Be Secured On Horizontal and Vertical Surfaces with Vacuum During Application
- Prevents Splashing When Used with Water

PART NO.	RECOMMENDED FOR	DESCRIPTION
ECOGRDCD	Core Drilling	Dust Collection Cover CD

## ECOGUARD G / G7

### DUST COLLECTION COVER FOR GRINDING



- Designed for Collecting Dust When Using A High-Speed Angle Grinder
- Accepts Grinding Wheels Up To: 5" (G5), 7" (G7)
- Rugged Construction for Heavy-Duty Applications
- Perfect for Grinding and Sanding or Surface Preparation Work
- Can Grind Tight Against The Wall
- Clear Cover for Better Visibility
- Fits On Most High-Speed Angle Grinders: 4-1/2"- 5" (G5), 7" & 9" (G7)
- Easy Installation and Wheel Changes
- The G7 Has A Flexible Head Allowing for A Natural Grinding Motion
- Removes More Than 90% of the Dust
- Must Be Used with A Vacuum

PART NO.	SIZE	DESCRIPTION
ECOGRDGR	5"	Dust Collection Cover G5
ECOGRDG7	7"	Dust Collection Cover G7
500026	18"	Flexible Connector Hose (1-1/2" Tapered-2-1/4")
500073	54"	Flexible Connector Hose (1-1/2" Tapered-2-1/4")
ECOGKIT	5"	Ecoguard G & 18" Connector Hose Kit
ECOG7KIT	7"	Ecoguard G7 & 54" Connector Hose Kit

## ECOGUARD G7



PART#: ECOGRDG7



# DUST COLLECTION COVERS

## ECOGUARD W5 / W6 / W9

## DUST COLLECTION COVER FOR WIDER KERF CUTTING



PART#: **ECOGRDW6**

PART#: **ECOGRDW5**

- Designed for Collecting Dust and Debris When Using A High-Speed Angle Grinder
- Perfect for Tuckpointing and Crack Chasing
- Accepts 5" Diameter Blades (W5), 6" Diameter Blades (W6), 7" and 9" Diameter Blades (W9)
- Removes More Than 90% Of Dust
- Rugged Construction for Heavy-Duty Applications
- Straight Precise Cuts Using Support Base
- Easy Installation and Blade Changes
- Fits On Selected 4-1/2", 5", 6", 7" and 9" High-Speed Angle Grinders
- Adjustable Cutting Depth - Maximum 1-1/2" (W5), 1-3/4" (W6) and 2-3/8" (W9)
- Must Be Used with A Vacuum

**Industrial  
Dust  
Collection  
Cover**



PART#: **ECOGRDW9**



**Includes  
extendable  
handle  
bracket**

PART#: **ECOW9KIT**

PART NO.	SIZE	DESCRIPTION
ECOGRDW5	5"	Dust Collection Cover W5
ECOGRDW6	6"	Dust Collection Cover W6
ECOGRDW9	9"	Dust Collection Cover W9
500026	18"	Flexible Connector Hose (1-1/2" Tapered-2-1/4")
500073	54"	Flexible Connector Hose (1-1/2" Tapered-2-1/4")
ECOW5KIT	5"	Ecoguard W5 & 18" Connector Hose Kit
ECOW6KIT	6"	Ecoguard W6 & 18" Connector Hose Kit
ECOW9KIT	9"	Ecoguard W9 & 54" Connector Hose Kit includes Extendable Handle Bracket (Part# 510000)

# DUST COLLECTION COVERS

## ECOGUARD C

### HYBRID DUST COLLECTION COVER FOR CUTTING



- Designed for Collecting Dust When Using A High-Speed Angle Grinder
- Accepts Up To 5" Diameter Blades
- Can Be Used with or Without A Vacuum
- Rugged Construction for Heavy-Duty Applications
- Removes More Than 90% Of Dust
- Fits On Selected 4-1/2" - 5" High-Speed Angle Grinders
- Straight Precise Cuts Using Foot Plate
- Adjustable Cutting Depth

PART NO.	SIZE	DESCRIPTION
ECOGRDCT	5"	Dust Collection Cover C
201549		Dust Bag
500026	18"	Flexible Connector Hose (1-1/2" Tapered-2-1/4")
500073	54"	Flexible Connector Hose (1-1/2" Tapered-2-1/4")

## ECOGUARD D

### DUST AND DEBRIS GUARDS FOR DRILLS / HAMMER DRILLS



- Collects Dust & Debris with Ease While Using Drills/ Hammer Drills
- Convenient and Easy to Use
- Eliminates Clean-Up and Downtime on the Jobsite
- Fits Most Popular Drills and Hammer Drills
- Made for: Makita® BHR202Z, Bosch RHH180, DeWalt DCH253, Milwaukee 2605-20, Hilti TE4-A18



Optional Universal Handle



Optional Vacuum Adapter Kit



Optional Exhaust Hose

PART NO.	SIZE	RECOMMENDED FOR	DESCRIPTION
ECOGRDDL	≥ 6"	Long Drill Bits	Dust Collection Cover DL
ECOGRDDS	≤ 6"	Short Drill Bits	Dust Collection Cover DS
803172		EcoGuard D	Universal Handle for Hammer Drills
ECOVAKIT		Use With EcoGuard D	Vacuum Adapter Kit
VH91100	12ft /3.6m	3/4" Hose Diameter	Exhaust Hose 1-1/4" O.D. threaded x 2-1/4" standard

## WET CORE BITS

## ULTIMATE WET CORE DRILLING BIT



- Designed for Drilling The Faucet-Mounting Holes in Countertops and Vanities
- Very Fast Cutting On Granite and Engineered Stone
- Make Clean Rounded Corners for Square or Rectangular Sinkholes
- Versatile and Adaptable in Many Industries for Water, Gas and Electrical Piping
- Fits On Most Popular Water-Fed Polishers

PART NO.	DIAMETER	MAXIMUM RPM	THREADS
DCB00380	3/8"	3,500	5/8"-11
DCB00500	1/2"	3,500	5/8"-11
DCB00750	3/4"	3,500	5/8"-11
DCB01000	1"	3,500	5/8"-11
DCB01250	1-1/4"	3,500	5/8"-11
DCB01375	1-3/8"	3,500	5/8"-11
DCB01500	1-1/2"	3,500	5/8"-11
DCB02000	2"	3,500	5/8"-11
DCB02500	2-1/2"	3,500	5/8"-11

## DRY CORE BITS

## ULTIMATE DRY CORE DRILLING BIT



- Designed for Jobsite Drilling Of Faucet-Mounting Holes in Countertops and Vanities
- Very Fast Cutting On Granite and Engineered Stone
- Convenient Dry Application
- Make Clean Rounded Corners for Square or Rectangular Sinkholes
- Versatile and Adaptable in Many Industries for Water, Gas and Electrical Piping
- Fits On Most Popular High-Speed Grinders

PART NO.	DIAMETER	MAXIMUM RPM	THREADS
DRB00500	1/2"	12,000	5/8"-11
DRB00750	3/4"	12,000	5/8"-11
DRB01000	1"	12,000	5/8"-11
DRB01250	1-1/4"	12,000	5/8"-11
DRB01375	1-3/8"	12,000	5/8"-11
DRB01500	1-1/2"	12,000	5/8"-11
DRB02000	2"	12,000	5/8"-11

## VACUUM BRAZED TRIMMER BIT

## DRY CUTTING OF LARGE HOLES OR CURVED LINES



- Great For Use In Construction Trades Wherever Non-Standard Shaped Cutouts Are Needed
- Perfect For Electrical Receptacles, Water-Valve Holes, Drains, Shower Knobs, Etc.
- Vacuum Brazed Technology Provides Extended Life
- Use On Granites, Engineered And Natural Stones, Porcelain And Ceramic Tiles
- Can Be Used Wet Or Dry
- Fits On A High-Speed Trimmer Tools

PART NO.	DIAMETER	MAXIMUM RPM
DTB00250	1/4"	33,000

## ELECTROPLATED DRILL BITS

## PREMIUM DRILL BITS FOR ANCHOR HOLES



- Designed for Drilling Holes in Tile and Stone for Pre-Installation or Post-Installation Placement
- Works Great On Marble, Granite, Engineered Stone, Ceramic, Porcelain and Glass Tile and Panels
- Can Be Used On A Standard 3/8" or Larger Drill
- Can Fit On Water-Fed Polishers with 5/8"-11 Spindles Using The Drill Bit Adapter
- Ideal for Drilling Holes for Anchors for Bathroom Fixtures, Faucet and Plumbing Pipes
- Available in 3/16", 1/4", 5/16", 3/8", 1/2", 1-3/8" and 1-1/2" Sizes
- A Must-Have for The Tile Installer's Tool Box
- Wet Use Only

PART NO.	DIAMETER	MAXIMUM RPM	TYPE
CH7205	3/16"	3,500	3/8" Shank
CH7206	1/4"	3,500	3/8" Shank
CH7208	5/16"	3,500	3/8" Shank
CH7210	3/8"	3,500	3/8" Shank
CH7212	1/2"	3,500	3/8" Shank
CH7235	1-3/8"	3,500	3/8" Shank
CH7240	1-1/2"	3,500	3/8" Shank
CH1058			Adapter 10mm to 5/8**

(\*for all polishers)

**EZ WEDGE SYSTEM**

**TILE LEVELING SYSTEM FOR EDGES AND CORNERS**

# EZ WEDGE SYSTEM

Leveling System Designed for Edges and Corners

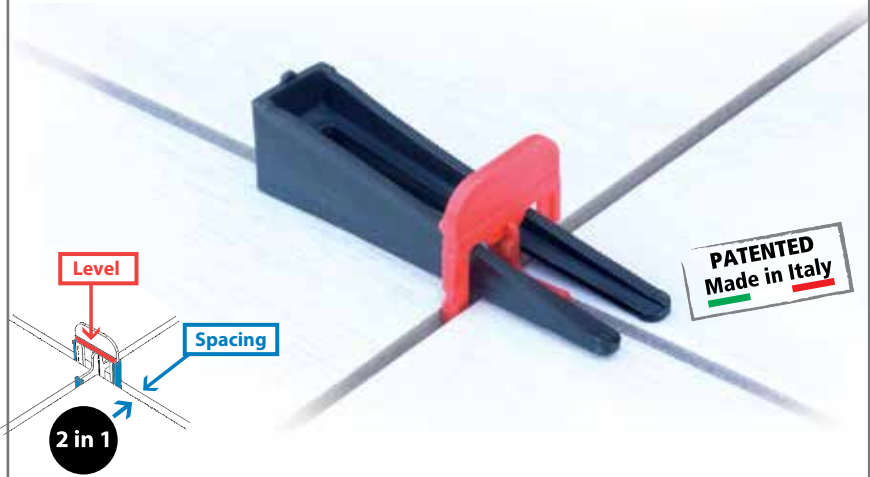

- ✓ Install Along Tile Edges
- ✓ Add Angle Tabs to Install on Corners
- ✓ Save Time & Money Up to 75%
- ✓ Available in 1/16" (1.5mm), 1/8" (3mm) & 3/16" (5mm)
- ✓ Dual Function - No Spacers Required

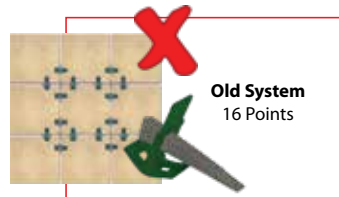
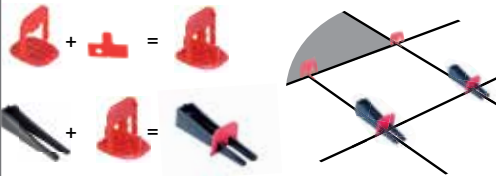
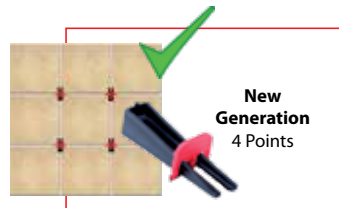

\* Optional Plier Available for Calibrated installations

PART NO.	SIZE	TYPE	COLOR	QTY
EZWEDGELV		Wedge		130
EZWCT15WH	1/16" (1.5mm)	Joint Clip & Angle Tab	White	200
EZWCT30RD	1/8" (3.0mm)	Joint Clip & Angle Tab	Red	200
EZWCT50BK	3/16" (5.0mm)	Joint Clip & Angle Tab	Black	200
EZPLIER		Plier		1

## EZ CLICK SYSTEM

## TILE LEVELING SYSTEM FOR EDGES AND CORNERS

# EZClick

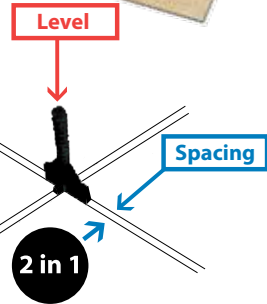
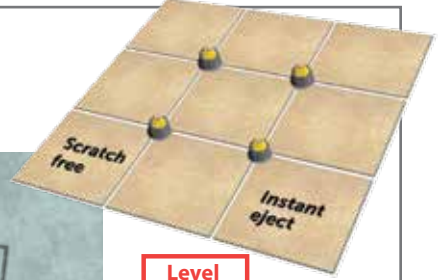

- Instant Screw Ejection Leveling System
- Supports Tile Thickness: 1/8" to 25/32" (3mm to 20mm)
- Levels and Spaces at The Same Time
- Tightens by Hand (No Tools Required)
- Minimum joint calibration: 1/32" (1mm)
- Ideal for Both Floor and Wall Tiling
- Proprietary Scratch-Prevention Edge
- Built-in spacer calibration: 3/32" (2mm), 1/8" (3mm) & 5/32" (4mm)
- Compatible With Many Older-Generation Systems
- \*Patent Pending

**Tightens and Releases by Hand**  
(No Tools Required)

The Quick and Reliable Leveling Cap

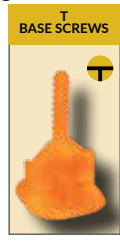
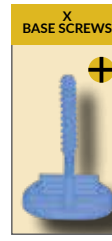
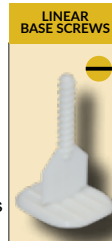

PART NO.	SIZE	TYPE	COLOR	QTY
EZCLICKCP		Screw Cap		50
EZCLB10WH	1/32" (1.0mm)	Linear Joint Screw Base	White	200
EZCLB20YW	3/32" (2.0mm)	Linear Joint Screw Base	Yellow	200
EZCLB30RD	1/8" (3.0mm)	Linear Joint Screw Base	Red	200
EZCLB40BK	5/32" (4.0mm)	Linear Joint Screw Base	Black	200
EZCXB20BL	3/32" (2.0mm)	X Joint Screw Base	Blue	200
EZCXB30VI	1/8" (3.0mm)	X Joint Screw Base	Violet	200
EZCXB40GY	5/32" (4.0mm)	X Joint Screw Base	Gray	200
EZCTB20BR	3/32" (2.0mm)	T Joint Screw Base	Brown	200
EZCTB30OR	1/8" (3.0mm)	T Joint Screw Base	Orange	200
EZCTB40GR	5/32" (4.0mm)	T Joint Screw Base	Green	200

EZ CLICK2 SYSTEM

TILE LEVELING SYSTEM FOR EDGES AND CORNERS

# EZ Click2



**Tightens and Releases by Hand**  
(No Tools Required)

- Designed for Wet Installation of 3/4" (2cm) Thick Pavers
- Instant Screw Ejection Leveling System
- Proprietary Scratch-Prevention Edge
- Built-in Spacer Calibration: 1mm and 4mm available
- Color Coded Base Screws for Easy Identification
- Cap Can Be Re-Used More Than 500 Times



PART NO.	SIZE	TYPE	COLOR	QTY
EZCLICKCP		Screw Cap		50
EZCLB10W2	1/32" (1.0mm)	Linear Joint Base Screw	White	200
EZCLB40B2	5/32" (4.0mm)	Linear Joint Base Screw	Black	200



## MANIFOLD SYSTEM

## FILTER REGULATOR MANIFOLD SYSTEMS



- Protects Your Tools From Contaminants
- Helps Prevent Pressure Drops When Using A Large Volume Of Air
- Adapts To The Existing Shop Piping and Increases The Life Of The Tools
- Makes It Easy To Get The Maximum Performance From Your Pneumatic Tools
- Comes in Two Sizes (53 CFM and 106 CFM)

### 1 Complete System for Multiple Tools

PART NO.	DESCRIPTION	ADAPTER BLOCK	CFM	PORT	PLUGS INCLUDED
1030-0021	3/8" Filter/Regulator Manifold	3/8" NPT	53	3 Couplers	(3) 1/4" Female NPT
1030-0022	3/8" Filter/Regulator Manifold	1/2" NPT	53	3 Couplers	(3) 1/4" Female NPT
1030-0023	1/2" Filter/Regulator Manifold	1/2" NPT	106	4 Couplers	(3) 1/4" Female NPT + (1) 3/8" Female NPT
1030-0024	1/2" Filter/Regulator Manifold	3/4" NPT	106	4 Couplers	(3) 1/4" Female NPT + (1) 3/8" Female NPT

### 2 Filter Regulator Kits for a Single Tool

PART NO.	SIZE	TYPE	THREADS	DESCRIPTION
1030-0070	53 CFM	3/8" Filter/Regulator Kit	1/2" IN-1/2" OUT	Filter/Regulator, Adapter Blocks & T-Clamps
1030-0071	53 CFM	3/8" Filter/Regulator Kit	1/2" IN-1/2" OUT	Filter/Regulator, Adapter Blocks & T-Clamps
1030-0072	53 CFM	3/8" Filter/Regulator Kit	1/2" IN-1/2" OUT	Filter/Regulator, Adapter Blocks & T-Clamps
1030-0073	106 CFM	1/2" Filter/Regulator Kit	3/4" IN-3/4" OUT	Filter/Regulator, Adapter Blocks & T-Clamps
1030-0074	106 CFM	1/2" Filter/Regulator Kit	3/4" IN-3/4" OUT	Filter/Regulator, Adapter Blocks & T-Clamps
1030-0075	106 CFM	1/2" Filter/Regulator Kit	3/4" IN-3/4" OUT	Filter/Regulator, Adapter Blocks & T-Clamps

## Filter/Regulator

# MANIFOLD SYSTEM

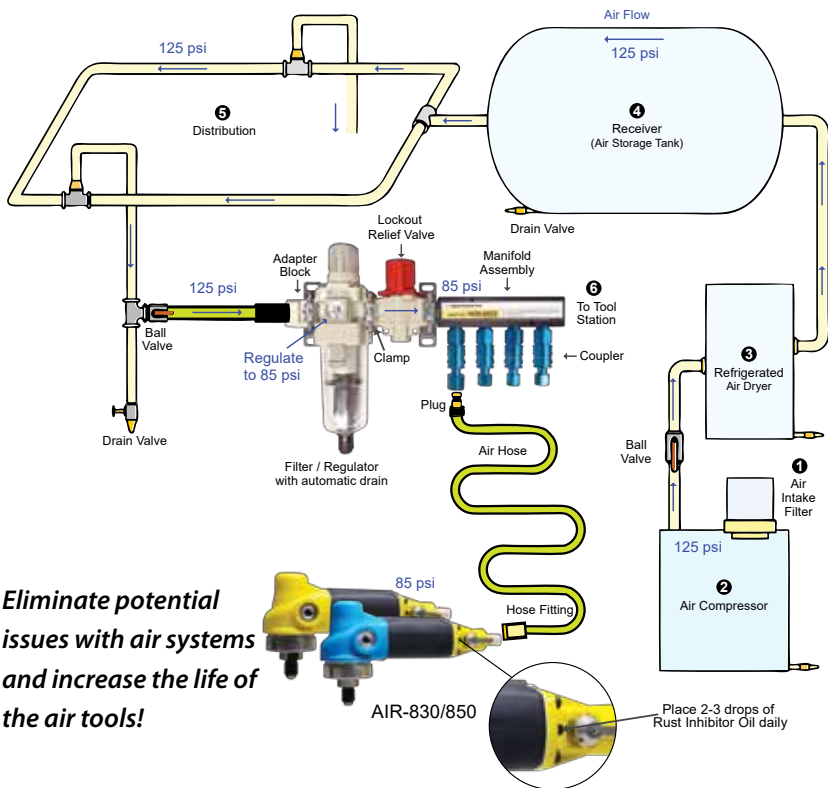

*Eliminate potential issues with air systems and increase the life of the air tools!*

Can be easily **CUSTOMIZED** to your shop requirements!

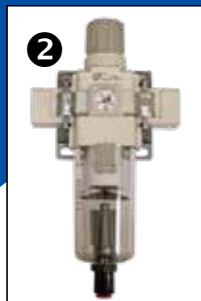
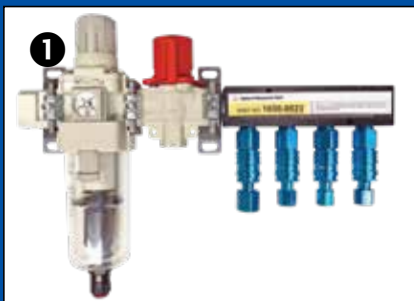

## HOSES

- All-Weather Flexibility From -40°F to +140°F
- Kink-Free Under Pressure
- Lightweight and Abrasion Resistant
- Zero Memory Allowing It To Lay-Flat
- Made Of A Premium Hybrid Polymer Material
- Comes in Many Lengths
- Pneumatic and Water Hoses Available
- Many Connectors Available



### AIR HOSE

(FOR PSG-658/830/850/PSC-600)

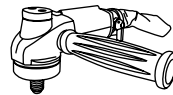

PART NO.	SIZE	DIAMETER	THREADS
1030-0002	15ft./4.5m	1/4"	1/4" NPSM x 1/4" NPT(Female Swivel)
1030-0010	20ft./6.0m	1/4"	1/4" NPSM x 1/4" NPT(Female Swivel)

Available Hose sizes: 25ft, 30ft, 35ft & 40ft. Call for Custom sizes or for more information.



### WATER HOSE

(FOR PSG-658/830/850/PSC-600)

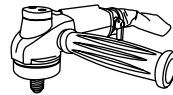

PART NO.	SIZE	DIAMETER	THREADS
1030-0003	15ft./4.5m	1/4"	1/8" NPSM x 3/4" 11GHT(GHT)
1030-0011	20ft./6.0m	1/4"	1/8" NPSM x 3/4" 11GHT(GHT)

Available Hose sizes: 25ft, 30ft, 35ft & 40ft. Call for Custom sizes or for more information.



### AIR HOSE

(FOR PSC-150 & PSG-125)

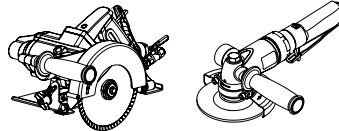

PART NO.	SIZE	DIAMETER	THREADS
1030-0031	15ft./4.5m	1/4"	3/8" NPSM x 1/4" NPT(Female Swivel)
1030-0033	20ft./6.0m	1/4"	3/8" NPSM x 1/4" NPT(Female Swivel)

Available Hose sizes: 25ft, 30ft, 35ft & 40ft. Call for Custom sizes or for more information.



## WATER HOSE (FOR PSC-150)

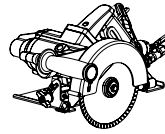

PART NO.	SIZE	DIAMETER	THREADS
1030-0032	15ft./4.5m	1/4"	1/4" NPSM x 3/4" 11GHT(GHT)
1030-0030	20ft./6.0m	1/4"	1/4" NPSM x 3/4" 11GHT(GHT)

Available Hose sizes: 25ft, 30ft, 35ft & 40ft. Call for Custom sizes or for more information.



## ADAPTER HOSE (FOR MANIFOLD SYSTEMS)

PART NO.	SIZE	DIAMETER	THREADS
1030-0025	1ft./0.3m	1/2"	1/2" NPT Swivel
1030-0026	2ft./0.6m	1/2"	1/2" NPT Swivel
1030-0027	3ft./0.9m	1/2"	1/2" NPT Swivel



## MOBILE HOSE (FOR MANIFOLD SYSTEMS)

PART NO.	SIZE	DIAMETER	THREADS
1030-0050	15ft./4.5m	1/2"	1/2" NPT Swivel w/Hose Protector
1030-0052	20ft./6.0m	1/2"	1/2" NPT Swivel w/Hose Protector

Available Hose sizes: 25ft, 30ft, 35ft & 40ft....Custom sizes also available. Call for more information.



## EXHAUST HOSE (SPECIALTY)

\*Use with ECOVAKIT

PART NO.	SIZE	DIAMETER	THREADS
VH91100	12ft./3.6m	3/4"	1-1/4" O.D. threaded x 2-1/4" standard



Multi-Purpose Waterproof Apron - **LONG SLEEVE**



Rubber Cuffs

Customizable Cuff  
with Easy  
Cut Lines for a  
Perfect Fit

Wet/Dry Use



**REGULAR**  
Part #- APRON2LSR

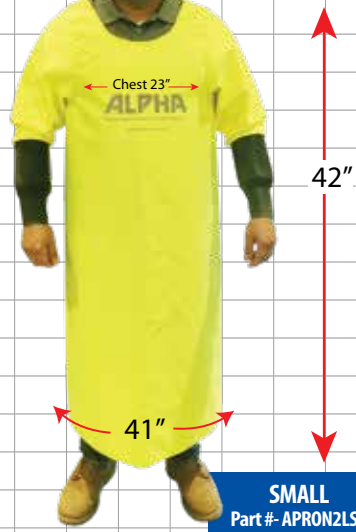

**SMALL**  
Part #- APRON2LSS

APRON

MULTI-PURPOSE  
APRON



- Rubber Cuffs Provides Full Coverage
- Bright Neon Yellow Color Provides Greater Visibility
- Perfect for Wet or Dry Environments
- Protects From Dust, Water and Other Chemicals
- Dual-Adjustable Clips Makes For A Perfect Fit



Dual-Adjustable Clips Makes for a Perfect Fit

PART NO.	SIZE	TYPE	DESCRIPTION
APRON2LSR	55" L X 60" W	Long Sleeve	Multi-Purpose Waterproof Apron (Regular)
APRON2LSS	42" L X 41" W	Long Sleeve	Multi-Purpose Waterproof Apron (Small)

APRON

MULTI-PURPOSE  
APRON SLEEVELESS



- Sleeveless with Wide Straps for Ease and Comfort
- Bright Neon Yellow Color Provides Greater Visibility
- Perfect for Wet or Dry Environments
- Protects From Dust, Water and Other Chemicals
- Dual-Adjustable Clips Makes For A Perfect Fit



Dual-Adjustable Clips Makes for a Perfect Fit

PART NO.	SIZE	TYPE	DESCRIPTION
APRON2000	55" L X 60" W	Sleeveless	Multi-Purpose Waterproof Apron (One Size Fits All)

**WET BLADE CUTTING KIT**

**CONVERT A HIGH-SPEED ANGLE GRINDER INTO A WET TOOL**



# WBC9KIT

**CUTTING**



- Can Be Used On Most Grinders With Minimal Alterations
- Fits Most 7" and 9" Angle Grinders
- Includes Kink-Free, Water-Feed Supplies, Plus GFCI
- Includes Extendable Handle Bracket to provide extra leverage for easy cutting power



**PROFILING**



**GRINDING**

**Kit includes:** 9" Safety Guard, Loc-Line Assembly, Plastic Tie, 4 Plastic Collars, Adapter (1/4 NPT>>>M10\*P.1.O), Water Hose Assembly, Memory Wrap (3ft. / 1M), Quick Connect Adapter, GFCI Plug (120V), Hook & Loop Tie & Screw w/Spring Lock Washer and Floor Cutting Kit (Part# 510000)

PART NO.	SIZE	TYPE	RECOMMENDED FOR	DESCRIPTION
WBC9KIT	9"	110V	7" & 9" High-Speed Angle Grinders	Wet Blade Cutting Kit
WBC9KIT2V	9"	220V	7" & 9" High-Speed Angle Grinders	Wet Blade Cutting Kit
510000			Cutting Applications	Extendable Handle Bracket



## WET BLADE CUTTING KIT

## CONVERT DRY GRINDER FOR WET CUTTING



- Designed To Convert A High-Speed Angle Grinder Into A Wet Tool
- Can Be Used On Most Grinders with Minimal Alterations
- Fits Most 4-1/2", 5" and 6" High-Speed Angle Grinders
- Kink-Free Water Hose for Easy Maneuverability and Reducing Operator Fatigue
- Save Money and Use Your Tool Wet or Dry!

**Kit includes:** Safety Guard, Loc-Line Assembly, Plastic Tie, Stainless Steel Collar, Plastic Collar, Adapter (1/4 NPT>>>M10\*P.1.O), Water Hose Assembly, Memory Wrap (3ft. / 1M), Quick Connect Adapter, GFCI Plug (120V) & Hook & Loop Tie

PART NO.	SIZE	TYPE	RECOMMENDED FOR	DESCRIPTION
WBC5KIT	5"	110V	4-1/2", 5" & 6" High-Speed Angle Grinders	Wet Blade Cutting Kit
WBC6KIT	6"	110V	4-1/2", 5" & 6" High-Speed Angle Grinders	Wet Blade Cutting Kit
WBC5KIT2V	5"	220V	4-1/2", 5" & 6" High-Speed Angle Grinders	Wet Blade Cutting Kit
WBC6KIT2V	6"	220V	4-1/2", 5" & 6" High-Speed Angle Grinders	Wet Blade Cutting Kit

## WET SANDING/ POLISHING KIT

## CONVERTS DRY POLISHER / SANDER INTO A WET TOOL



- Designed To Convert A Dry Polisher Into A Wet Tool
- Save Money and Use Your Tool Wet or Dry!
- Quick Solution for OSHA Compliance
- Kit includes: Safety Guard, Loc-Line Assembly, Water Hose Assembly, Memory Wrap (3ft. / 1M), Quick Connect Adapter, GFCI Plug (120V) & Hook & Loop Strap



PART NO.	RECOMMENDED FOR	DESCRIPTION
WSPKIT	Sanders & Polishers	Wet Sanding & Polishing Kit

## CORNER RULER

## UNIQUE TOOLS FOR FABRICATING CORNERS



- Mark, Cut and Grind The Square Corners of Glass, Tile, Stone, Porcelain Plastic and Wood
- Sets Comes with Either Two Radiuses or Two 45-Degree Straight Lines
- Makes for Quick and Easy Preparation Time
- Sets Come in A Stainless Steel Case for Organization



PART NO.	DESCRIPTION
CRR1075	Ruler Radius 3/8"+3"
CRR1570	Ruler Radius 5/8"+2-3/4"
CRR2065	Ruler Radius 3/4"+2-5/8"
CRR2560	Ruler Radius 1"+2-1/2"
CRR3055	Ruler Radius 1-1/4"+2-3/8"
CRR3550	Ruler Radius 1-3/8"+2"
CRR4045	Ruler Radius 1-1/2"+1-3/4"
CRRSET7	Ruler Radius Set w/Case
CRS1075	Ruler Straight 3/8"+3"
CRS1570	Ruler Straight 5/8"+2-3/4"
CRS2065	Ruler Straight 3/4"+2-5/8"
CRS2560	Ruler Straight 1"+2-1/2"
CRS3055	Ruler Straight 1-1/4"+2-3/8"
CRS3550	Ruler Straight 1-3/8"+2"
CRS4045	Ruler Straight 1-1/2"+1-3/4"
CRSSET7	Ruler Straight Set w/Case
CRSET14	Ruler Combo Set

## DUST CARRIAGE

## DUST CONTROL CARRIAGE SYSTEM



- Designed As A Support To Hold The Dust Bag When Cutting or Grinding
- Conveniently Pulls Behind The Tool So As Not To Interfere with The Job
- Front Swivel Wheels Allows for Easy Maneuvering
- Dust Bag Is Easily Secured To The Dust Carriage with Ties
- Recommended for Flat Surfaces

PART NO.	SIZE	TYPE	DESCRIPTION
ECO-CARS	5"	110V	Dust Bag Carriage (includes Dust Bag)
801392	16" x 13-1/2" X 8"		Dust Bag

## GLOSS CHECKER



- Portable Gloss Meter Designed To Measure The Reflective Index Of Light
- Enables Quick, Accurate Measurements Of Gloss On Flat, Polished Surfaces
- Ensures Quality Control and Assists Setting Standards
- Detachable Meter for Difficult To Reach Areas
- Can Be Used Across Multiple Industries

PART NO.	DESCRIPTION
IG-331	Gloss Meter

## SAFETY GLASSES



- Designed for Safety and Comfort
- A Lightweight Frame with Padded Temples
- Adjustable Side Arms
- Soft Rubber Nose Bridge
- Clear Anti-Scratch Lenses
- Available in a single pair or 12-pack
- Complies with standard # BS EN 166:2001

PART NO.	DESCRIPTION
173002	Safety Glasses (Box of 12)
173008	Safety Glasses (Single Pair)

## GROUND FAULT CIRCUIT INTERRUPTER



- Protect Polishing Personnel From Lethal Ground Current Loads
- Highly Recommended Piece Of Equipment
- Rated for 15 Amps

PART NO.	DESCRIPTION	TYPE
GFCI-1	Ground Fault Circuit Interrupter	110V
GFCI-2	Ground Fault Circuit Interrupter	220V

# INNOVATIVE SOLUTIONS

# G-Tape

Multi-Purpose  
Surface Protection  
and Repair Tape

## Key Features and Benefits

- Hand Tearing-Straight and Easy
- Residue Free Removal
- Waterproof
- All-Weather Usage (-40°F to +200°F)
- Repositionable
- Highly Weather/UV Resistant
- Good Surface Protection
- Great for Quick Repairs
- Easily Mark Tape with Ball Point Pen, Permanent Marker, China Marker, etc.
- Available as a single roll or Case of 30 pcs.

LDPE film \_\_\_\_\_

HDPE cloth \_\_\_\_\_

LDPE film \_\_\_\_\_

Acrylic PSA layer \_\_\_\_\_



All G-Tape™ products feature a patented combination of solvent acrylic adhesive with an advanced backing substrate that results in unmatched performance.

**G-TAPE**

**ALL PURPOSE  
PROTECTION & REPAIR TAPE**

**Nichigo G-Tape™ 1000 Series**

**Multi-Purpose Surface Protection and Repair Tape**



- Hand Tearing-Straight and Easy
- Residue Free Removal
- Waterproof
- All-Weather Usage (-40°F to +200°F)
- Repositionable
- Highly Weather/UV Resistant
- Good Surface Protection
- Great for Quick Repairs
- Easily Mark Tape with Ball Point Pen, Permanent Marker, China Marker, etc.
- Available as a single roll or Case of 30 pcs.

PART NO.	COLOR	SIZE	BOND TYPE
1009CL-GT-2-164	Clear	2" x 164' (50mm x 50m)	Removable
1009GR-GT-2-164	Green	2" x 164' (50mm x 50m)	Removable
1006TG-GT-2-82	Black & Yellow	2" x 82' (50mm x 25m)	Removable

**Nichigo G-Tape™ 1008 Series**

**Long Term Masking and Storage**



- Surface Protection of Metallic Raw Materials In Outdoor Settings
- Long Term Masking For Painting And Welding
- Hand Tearing-Straight and Easy
- Scrap-Less: Face To Face Contact Of Adhesive Separates Without Damaging The Adhesive
- High Weather Resistance: Residue Free Removal Even After 6 Months
- Repositionable
- All-Weather Usage (-40°F to +200°F)

PART NO.	COLOR	SIZE	BOND TYPE
1008BK-GT-2-164	Black	2" x 164' (50mm x 50m)	Removable
1008SW-GT-2-164	White	2" x 164' (50mm x 50m)	Removable

**G-TAPE**

**ALL PURPOSE  
PROTECTION & REPAIR TAPE**

**Nichigo G-Tape™ 3035 Series**

**Self-Adhering Flashing Tape (Without Liner)**



- Designed for Seaming, Splicing Of Insulation Sheets, House Wraps, And Wall Boards
- Easy To Tear By Hands Straight
- Perfect for Use As A Waterproofing Tape On Outdoor Deck's Rafter
- Great for Seaming, Splicing Around Window Frame
- Scrap-Less: Face To Face Contact Of Adhesive Separates Without Damaging The Adhesive
- Lightweight: 50 To 70% Lighter Than Conventional Window Flashing Tape
- Highly Weather/UV Resistant
- All-Weather Usage (-40°F to +200°F)
- Meets AAMA 711-13; Type A (without primer), Level 3 (exposure up to 176°F) and AC 148

PART NO.	COLOR	SIZE	BOND TYPE
3035BK-GT-2-65	Black	2" x 65' (50mm x 20m)	Permanent
3035BK-GT-3-65	Black	3" x 65' (75mm x 20m)	Permanent
3035BK-GT-4-65	Black	4" x 65' (100mm x 20m)	Permanent

**Nichigo G-Tape™ 3040 Series**

**High Adhesion Acrylic Flashing Tape**



- Perfect Flashing for Windows, Doors, & Deck Beams
- Hand Tearing-Straight and Easy
- Waterproof
- All-Weather Usage (-40°F to +200°F)
- AAMA 7-11 Level 3 Class A Certified
- Highly Weather/UV Resistant
- Permanent Adhesion
- Cleanly Removes from Face-to-Face Adhesive Contact
- Available as a single roll or by the case

PART NO.	COLOR	SIZE	BOND TYPE
3040BK-GT-2-65	Black	2" x 65' (50mm x 20m)	Permanent
3040BK-GT-4-65	Black	4" x 65' (100mm x 20m)	Permanent
3040BK-GT-6-65	Black	6" x 65' (150mm x 20m)	Permanent
3040BK-GT-9-65	Black	9" x 65' (225mm x 20m)	Permanent
3040BK-GT-12-65	Black	12" x 65' (300mm x 20m)	Permanent

# Nichigo G-Tape™ 3045 Series

Self-Adhering Flashing Tape

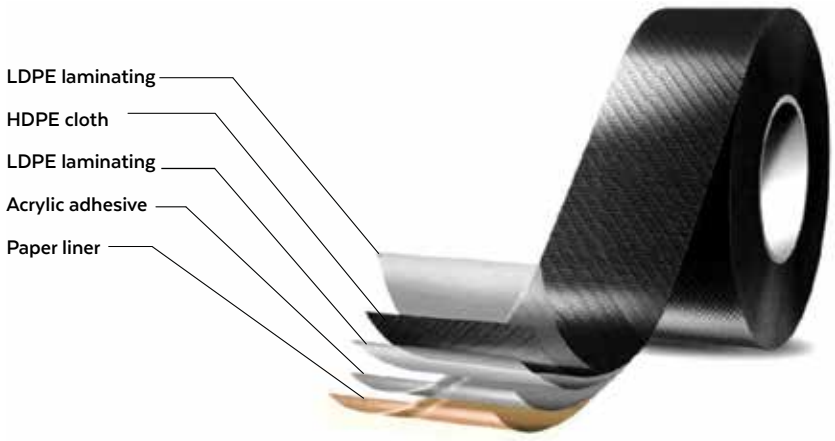

- Designed for Seaming Various Rubber Sheets with A High Static Shear To Rubber
- Excellent Adhesion To Rubber (Ex. Ethylene Propylene Diene (EPDM) Rubber)
- Easy To Tear By Hands Straight: No Cutting Tool Is Required
- Scrap-Less: Face To Face Contact Of Adhesive Separates Without Damaging The Adhesive
- Great Replacement For Asphalt Tape And/Or Butyl Tape
- Repositionable – No Wrinkles When Applied
- All-Weather Usage (-40°F to +200°F)
- Meets AAMA 711-13; Type A (without primer), Level 3 (exposure up to 176°F) and AC 148

PART NO.	COLOR	SIZE	BOND TYPE
3045BK-GT-2-65	Black	2" x 65' (50mm x 20m)	Permanent
3045BK-GT-3-65	Black	3" x 65' (75mm x 20m)	Permanent
3045BK-GT-4-65	Black	4" x 65' (100mm x 20m)	Permanent



# Surface Protection

## Repositionable Waterproof Surface Protection Tape



- Ideal For Masking For Concrete, Stucco, Mortars, And Bricks
- Easy To Tear By Hands Straight: No Cutting Tool Is Required
- High Weather Resistance: Residue Free Removal Even After 1 Month
- Scrap-Less: Face To Face Contact Of Adhesive Separates Without Damaging The Adhesive
- Using As A Line Tape And Caution Sign Tape
- Repositionable – No Wrinkles When Applied
- Perfect For A Quick Stick On Various Materials
- All-Weather Usage (-40°F to +200°F)
- Also Available in Blue and Red Upon Request

PART NO.	COLOR	SIZE	BOND TYPE
BAB0650	Black	6" x 164' (150mm x 50m)	Large Surface Protection
2010BK-GT-2-164	Black	2" x 164' (50mm x 50m)	Removable
2010BK-GT-6-164	Black	6" x 164' (150mm x 50m)	Removable

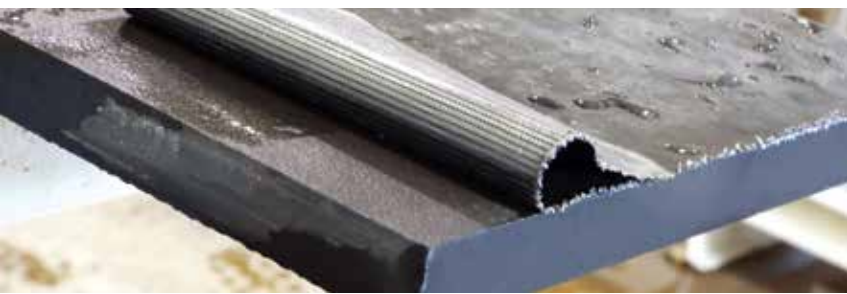

**RSR-2000**

**RUST STAIN REMOVER  
IN GEL FORM**



- Removes Common Rust Stains From Natural Stone Surfaces, Concrete, Brick, Terra Cotta, Mexican Tile, or Other Hard Porous Surfaces
- Specially Formulated To Work Extremely Fast
- Non-Hazardous Chemical Is Safe To Use and Will Not Harm The Environment
- Use On Floors, Countertops, Vertical Surfaces and Exterior Areas
- Available in 14oz Tube or Trial Size 1.4oz Bottle
- Tube Covers Approximately 4 sqft

PART NO.	SIZE	CONTAINER
RSR-400G	14 oz. (400g)	Tube
RSR-040G	1.4 oz. (40g)	Bottle



# Index

## A

Adapter Hose 81  
AIR-300 24  
AIR-680UW 21  
AIR-830 / AIR-834 22  
AIR-850 / AIR-854 22  
AIR Hose 80  
Antique Brush Wheels 68  
Apron 83  
AWS-110 8

## B

Beveling Base Starter Kit 26  
Beveling Auxiliary Base 25  
Beveling Base  
Applications 27  
Blademaster 45

## C

Ceramica Dry 62  
Ceramica Edge 58  
Ceramica EX 60  
Ceramica Metal 58  
Ceramica Resin 59  
Ceramica TF 60  
Ceramica Vitrified 58  
Contour 41  
    Granite & Eng. Stone 42  
    Porcelain 41  
Cordless Saw Blade  
    Ceramic Tile 39  
    Glass 39  
Corner Ruler 86  
Countertop Trim Kit 4

## D

Diamond Face Foam Pads 17  
Dressing Stick 46  
Dry Core Bits 73  
DS Style 54  
Dust Carriage 87  
DW Style 54

## E

ECC-125 9, 10  
ECC-KIT 10  
Eclipse II 30  
Eclipse Q 30  
Ecoguard Type C 72  
Ecoguard Type CD 70  
Ecoguard Type D 72  
Ecoguard Type G 70  
Ecoguard Type W Series 71  
Electroplated Drill Bits 74  
ESC-125 2

Exhaust Hose 81  
EZ Click System 76, 77  
EZ Thin Tile Cutters 48  
EZ Wedge System 75

## F

Felt Wheels 68  
Flexible Backer Pad 69

## G

Gloss Checkers 87  
Groove Cutter 44  
Ground Fault  
Circuit Interrupter 87  
G-Tape 89  
Guide Rails 47  
GV Backer Pads 69

## H

Hand Pads 62  
Hoses 80  
Hot-Rod 43

## K

Katana 31  
Kirara Pads 61

## L

Laminam® 35  
Libero 33

## M

Manifold System 79  
Manifold System 78  
Marble Profile Wheel 44  
Mobile Hose 81

## P

Plus 29  
Porcellana 37  
    For Portable Rail Saw 37  
Profilers  
    B-Series 49  
    V-Series 50  
    Z-Series 50  
PSC-150 1, 7  
PSC-150 Miter Cutting Kit 5  
PSC-600 1  
PSG-125  
    Diamond Cutting Kit 13  
    Grinding Kit 13  
    Dust-Free Grinding Kit 13  
PSG-658 11  
PVA MS Style 64  
PVA QC Style 65  
PVA VP Style 63

## Q

Q-Cut 38  
Quad 29  
Quad Adapters 46

## R

Rescue 45  
Rigid Backer Pad 69  
Rotary Backer Pad 16  
RSR-2000 93

## S

Sandpaper 56  
Sonic 35  
Spike Disc 51  
Spike Ruler 46

## T

Tile Bullnose Kit 19  
Trim Master 33  
Tuck Point 32  
Turboshine 66, 67

## U

Ultrack  
    APR Series 34  
    GPM Series 34

## V

Vacuum Brazed  
Trimmer Bit 74  
VDP-700 14  
Vetro  
    For Portable Rail Saw 36  
Vexcel Rigid Disc 53  
Vextra Flat Disc 52  
VFlex Sanding Disc 55  
Vortex  
    For Granite 40  
    For Marble 40  
VSP-320 18

## W

Water Hose 81  
WBC9KIT 84  
WDP-320 20  
Wet Blade Cutting Kit 84, 85  
Wet Core Bits 73  
Wet Sanding/  
    Polishing Kit 85  
Wool Pads 16

## Product Literature

### Catalogs

Alpha® provides product catalogs for all products to best serve the particular needs of our customers. Catalogs are available for applications such as Hand Tooling and Large Machine Tooling, as well as for specific industries such as stone, tile, construction, industrial, automotive, composites, glass and marine.

All of our catalogs are a convenient portable of size 5.5" x 8.5", and illustrate the tools and accessories needed for Cutting, Profiling, Grinding, Drilling, Polishing and Restoring all types of materials.

To request these catalogs, or for more information about our product line, visit our website at [www.alpha-tools.com](http://www.alpha-tools.com) or contact us at 800-648-7229.



## ALPHA® TOOL REPAIR

- Authorized repair centers available
- All tool repairs carry a 30-day warranty
- Quick turn-around time
- Technical support for repair and maintenance
- Order replacement tool parts directly from Alpha®
- Loaner program available

Visit our website to find a local center



## Let's get social...



**We are ready to connect with you on your favorite social media sites... Join Us Today!**

 **Alpha Professional Tools®**

16 Park Drive • Franklin, NJ 07416  
800-648-7229 • Fax: 800-286-0114



[www.alpha-tools.com](http://www.alpha-tools.com)