

Alpha[®] Variable Speed Wet Polisher Instruction Manual

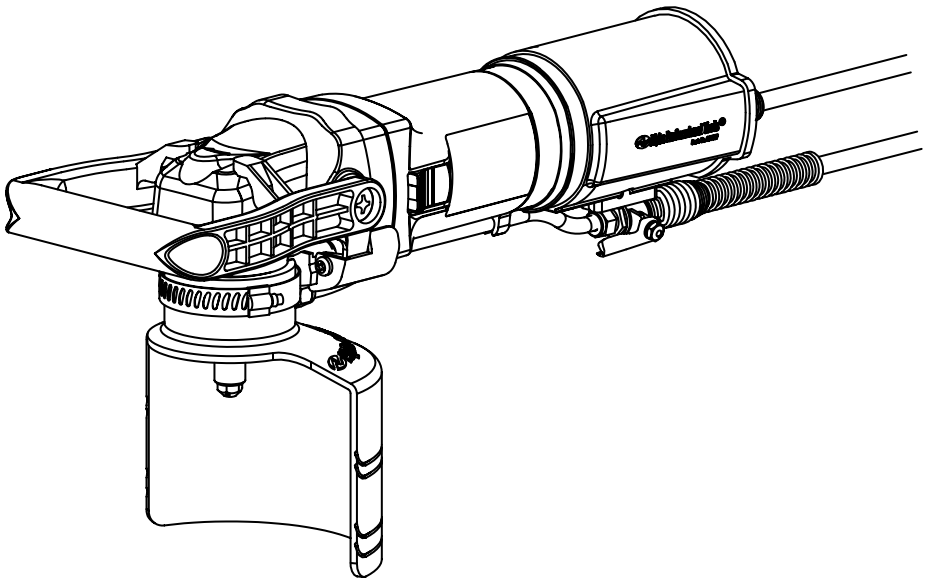

Model No.: VSP-320

Version 1

WARNING: To reduce the risk of injury, user must read and understand instruction manual!

 **Alpha Professional Tools[®]**

103 Bauer Drive, Oakland, NJ 07436 • 800-648-7229 • Fax: 800-286-0114
www.alpha-tools.com

TABLE OF CONTENTS

Introduction.....	2
About Symbols.....	2
General Safety Rules	3
Electrical Safety.....	4
Tool Use and Care	5
Service	6
Specific Safety Rules.....	6
Use Proper Extension Cords	7
Grounding Instructions.....	7
Additional Precautions for using the VSP-320	7
Laws and Regulations Of Noise Levels	8
VSP-320 Overview	9
Specifications.....	9
Accessories	10
Components.....	10
VSP-320 Variable Speed Wet Polisher Operation.....	11
Main Connection.....	11
Switching On and Off.....	11
Ground Fault Circuit Interrupter (GFCI)	12
Testing In-line GFCI Unit.....	13
Variable Speed Adjustment.....	13
Speed Pot Feedback Sensor.....	14
Water Control Valve	14
Side Handle Installation	15
Customizing Splash Guard	16
Splash Guard Installation.....	17
Profiler and other approved Spindle Attachments.....	18
Water-Feed Attachment	18
Maintenance.....	19
Daily.....	19
Periodic.....	20
Bearings and gears.....	20
Carbon Brush Replacement.....	20
Rear Cover Removal	21
Alpha® VSP-320 Schematic.....	26
Alpha® VSP-320 Parts List	27
Accessories and Factory Service	29
Warranty	29
Product Registration Card	30

INTRODUCTION

Thank you for purchasing the Alpha® Variable Speed Wet Polisher. Please read this instruction manual thoroughly to ensure safety and correct use of the polisher. Keep this manual in a place where operators can access it easily whenever necessary.

► ABOUT THE SYMBOLS

According to the hazard level, all safety notes in this manual are classified into “DANGER”, “WARNING”, and “CAUTION”.

 **DANGER!** Death or serious personal injury is imminent when handling this polisher incorrectly.

 **WARNING!** There is a possibility of death or serious personal injury when handling this polisher incorrectly.

 **CAUTION!** There is a possibility of personal injury or property damage when handling this polisher incorrectly.

NOTE: *In some situations, failing to observe WARNING notes could result in death or serious personal injury. Be sure to read and observe the safety notes to ensure safety and correct use of the polisher.*

ELECTRICAL SYMBOLS

The following show the symbols used for tool.

V	Volts
A	Amperes
W	Watts
Hz	Hertz
~ or a.c.	Alternating Current
n0	No load speed
.../min	Revolution or reciprocation per minute
kg	Kilograms
mm	Millimeters
lbs	Pounds
	Protective Earth

CAUTION

The following are important notes for products, operation, and maintenance applicable to this polisher.

GENERAL SAFETY RULES

1. **KNOW YOUR POWER TOOL.** Read owner's manual carefully. Learn its applications and limitations as well as specific potential hazards particular to this tool.
2. **KEEP WORK AREA CLEAN.** Cluttered areas and benches invite accidents.
3. **AVOID DANGEROUS ENVIRONMENTS.** Keep work areas as dry as possible. Do not use tool in presence of flammable liquids or gases. Keep the area well lit.
4. **KEEP CHILDREN AND VISITORS AWAY.** All visitors should be kept a safe distance from the work area. Keep out of reach of children.
5. **DON'T FORCE TOOL.** It will do the job better and safer at the rate for which it was designed.
6. **WEAR PROPER APPAREL.** Do not wear loose clothing or jewelry as it can get caught in moving parts. Rubber gloves and insulated non-skid footwear are recommended. Wear protective covering to contain long hair.
7. **WEAR PROPER EYE PROTECTION.** All users and bystanders must always wear proper personal eye protection which conform with ANSI/ISEA Z87.1 (CAN/CSA Z94.3). Also use a face or dust mask if operation is dusty. Always wear certified safety equipment.
8. **WEAR PROPER EAR PROTECTION.** All users and bystanders must wear proper personal ear protection which conforms with ANSI S12.6 (S3.19) hearing protection.
9. **WEAR PROPER RESPIRATORY PROTECTION.** All users and bystanders must wear proper personal respiratory protection. Always use NIOSH/OSHA approved respiratory protection appropriate for the dust exposure.

Warning: Some dust created by power sanding, sawing, grinding, drilling, polishing and other construction activities contains chemicals known to the State of California to cause cancer, birth defects, or other reproductive harm.

Some examples of these chemicals are:

- Lead from lead-based paints
- Crystalline silica from bricks, cement and other masonry products, and
- Arsenic and chromium from chemically-treated lumber.

Your risk from these exposures varies, depending on how often you do this type of work. To reduce your exposure, work in a well ventilated area, and work with approved safety equipment, such as dust masks that are specially designed to filter out microscopic particles. To familiarize with the risks associated with a material, consult with your employer, manufacturer/supplier and government agencies regarding the hazards of the materials and their recommendations to protect yourself.

10. **DON'T ABUSE WATER SUPPLY HOSE.** Don't carry tool by supply hose or expose to traffic areas where it can be crushed.
11. **ALWAYS SECURE WORK PIECE.** Use clamps or a vise to hold work. It's safer than using your hand and it frees both hands to operate tool.
12. **DON'T OVERREACH.** Keep proper footing and balance at all times.
13. **DISCONNECT TOOLS WHEN NOT IN USE.** Always disconnect tool before servicing when changing blades.
14. **REMOVE ADJUSTING KEYS AND WRENCHES.** Form a habit of checking to see that keys and adjusting wrenches are removed from tool before turning it on.
15. **MAINTAIN TOOLS WITH CARE.** Keep tools clean at all times for best and safest performance. Follow instructions for lubricating and changing accessories. Keep handles dry, clean and free of oil or grease. Inspect moving parts for alignment and binding as well as for breakage and improper mounting.
16. **AVOID ACCIDENTAL STARTING.** Do not carry a "connected" tool, or make adjustments, or change discs without making sure the tool is disconnected from the power supply.
17. **USE ONLY RECOMMENDED ACCESSORIES.** The use of any accessories other than what is listed or recommended for this particular tool may be hazardous.
18. **KEEP HANDS AWAY FROM ALL MOVING PARTS.**
19. **USE SIDE HANDLES.** Supplied with tool for control and safety.
20. **STAY ALERT.** Watch what you are doing and use common sense. Do not operate tool when you are tired, or under the influence of medication or alcohol.

►**ELECTRICAL SAFETY**

- **Grounded tools must be plugged into an outlet properly installed and grounded in accordance with all codes and ordinances.** Never remove the grounding prong or modify the plug in any way. Do not use any adaptor plugs. Check with a qualified electrician if you are in doubt as to whether the outlet is properly grounded. If the tools should electrically malfunction or breakdown, grounding provides a low resistance path to carry electricity away from the user.
- **Ground Fault Circuit Interrupter (GFCI) protection should be provided on the circuit or outlet to be used for the tool.** Receptacles are available having built-in GFCI protection and may be used for this measure of safety.
- **Avoid body contact with grounded surfaces, such as pipes, radiators, ranges, and refrigerators.** There is an increased risk of electric shock if your body is grounded. Don't expose power tools to rain or wet conditions. Water entering a power tool will increase the risk of electric shock.
- **Make sure the extension cord is in good condition.** When using an extension cord, be sure to use one heavy enough to carry the current your product will draw. An undersized cord will cause a drop in line voltage resulting in loss of power and overheating.

- **Do not abuse the cord.** Never use the cord to carry the tools or pull the plug from an outlet/receptacle. Keep cord away from heat, oil, sharp edges, or moving parts. Replace damaged cords immediately. Damaged cords increase the risk of electric shock or fire.
- **When operating a power tool outside, use an outdoor extension cord marked “W-A” or “W”.** These cords are rated for outdoor use and reduce the risk of electric shock.

► **TOOL USE AND CARE**

- **Use clamps or other practical ways to secure and support the workpiece to a stable platform.** Holding the work by hand or against your body is unstable and may lead to loss of control.
- **Inspect for and remove all foreign objects from workpiece before polishing.** Following this rule will reduce the risk of serious personal injury.
- **Avoid accidental starting. Be sure switch is off before plugging in.** Carrying tools with your finger on the switch or plugging in tools that have the switch on, invites accidents.
- **Keep hands away from polishing area.** Following this rule will reduce the risk of cuts, scrapes, or serious personal injury.
- **Hold tool by insulated gripping surfaces when performing an operation where the tool may contact hidden wiring or its own cord.** Contact with a “live” wire will make exposed metal parts of the tool “live” and shock the operator.
- **Do not force tool, use the correct tool for your application.** The correct tool will do the job better and safer at the rate for which it is designed.
- **Do not use tool if switch does not turn it on or off.** Any tool that cannot be controlled with the switch is dangerous and must be repaired.
- **Disconnect the plug from power source before making any adjustments, changing accessories, or storing the tool.** Such preventive safety measures reduce the risk of starting the tool accidentally.
- **Check for damaged parts.** Before further use of the tool, check the guard or other part to determine if it is damaged or that it will operate properly and perform its intended function. Check for alignment of moving parts, breakage of parts, mounting, and any other conditions that may affect its operation. A guard or other part that is damaged should be properly repaired or replaced by an authorized service center unless otherwise indicated elsewhere in this instruction manual. Have defective switches replaced by authorized service center.
- **Store idle tools out of the reach of children and other untrained persons.** Tools are dangerous in the hands of untrained users.
- **Know your power tool. Read operator’s manual carefully.** Learn its applications and limitations, as well as the specific potential hazards related to this tool. Following this rule will reduce the risk of electric shock, fire, or serious injury. Refer to them frequently and use them to instruct others who may use this tool. If you loan someone this tool, loan them these instructions.

►SERVICE

- Tool service must be performed only by qualified repair personnel. Service or maintenance performed by unqualified personnel could result in a risk of injury.
- When servicing a tool, use only identical replacement parts. Follow instructions in the Maintenance section of this manual. Use of unauthorized parts or failure to follow maintenance instructions may create a risk of electric shock or injury.

►SPECIFIC SAFETY RULES

1. **Accessories must be rated for at least the speed recommended on the tool warning label.** Wheels and other accessories running over rated speed can fly apart and cause injury.
2. **Hold tool by insulated gripping surfaces when performing an operation where the cutting tool may contact hidden wiring or its own cord.** Contact with a “live” wire will make exposed metal parts of the tool “live” and shock the operator.
3. **Always wear safety glasses with side shields.** Everyday eye-glasses have only impact resistant lenses; they are NOT safety glasses.
4. **Protect your lungs.** Wear a face or dust mask if the operation is dusty.
5. **Protect your hearing.** Wear hearing protection during extended periods of operation.
6. **Inspect tool cords periodically and if damaged, have repaired at your nearest Factory Service Center or other Authorized Service Organization.** Constantly stay aware of cord location.
7. **Check damaged parts.** Before further use of the tool, a guard or other part that is damaged should be carefully checked to determine that it will operate properly and perform its intended function.
8. **Check for alignment of moving parts, binding of moving parts, breakage of parts, mounting, and any other conditions that may affect its operation.** A guard or other part that is damaged should be properly repaired or replaced by an authorized service center.
9. **Do not abuse cord.** Never carry the tool by the cord or yank it to disconnect it from the receptacle. Keep cord away from heat, oil, and sharp edges. Following this rule will reduce the risk of electric shock or fire.
10. **Make sure your extension cord is in good condition.** When using an extension cord, be sure to use one heavy enough to carry the current your product will draw. An undersized cord will cause a drop in line voltage resulting in loss of power and overheating.
11. **Inspect for and remove all foreign objects from workpiece before polishing.** Follow this rule will reduce the risk of serious personal injury.
12. **Drugs, alcohol, medication, Do not operate tool while under the influence of drugs, alcohol, or any medication.** Follow this rule will reduce the risk of electric shock, fire, or serious personal injury.

13. **Keep hands away from polishing area.** Follow this rule will reduce the risk of cuts, scrapes, or serious personal injury.
14. **Ground Fault Circuit Interrupter (GFCI) protection should be provided on the circuit or outlet to be used for the tool.** Receptacles are available having built-in GFCI protection and may be used for this measure of safety.
15. **Save these instruction.** Refer to them frequently and use them to instruct others who may use this tool. If you loan someone this tool, loan them these instructions.

► **USE PROPER EXTENSION CORDS**

Use only three-wire extension cords that have three-prong grounding-type plugs and three-pole receptacles that accept the tool's plug. Make sure your extension cord is in good condition. Replace or repair damaged or worn cord immediately. When using an extension cord, be sure to use one heavy enough to carry the current your product will draw. An undersized cord will cause a drop in line voltage resulting in loss of power and overheating. Below table shows the correct size to use depending on cord length and nameplate ampere rating. If in doubt, use the next heavier gauge. The smaller the gauge number, the heavier the cord.

Ampere Rating		Total length of cord in feet (120V)		
		25ft	50ft	100ft
More Than	Not More Than	AWG		
0	6	18	16	16
6	10	18	16	14
10	12	16	16	14
12	16	14	12	Not Recommended

► **GROUNDING INSTRUCTIONS**

This tool should be grounded while in use to protect the operator from electric shock. The tool is equipped with a three-conductor cord and three-prong grounding type plug to fit the proper grounding type receptacle. The green (or green and yellow) conductor in the cord is the grounding wire. Never connect the green (or green and yellow) wire to a live terminal.

► **ADDITIONAL PRECAUTIONS FOR USING THE VSP-320**

In addition to the general safety notes described on the preceding pages, please read and observe the following precautionary notes before using the polisher.

 **DANGER!**

1. **Check the working voltage.** Be sure the voltage available at power outlet matches specified voltage on the name- plate. If the polisher is used with higher voltage than specified, the motor will burnout. Any attempts to do so may damage the polisher or cause an accident or injury.
2. **Inspect all polishing discs.** Never use cracked, chipped or damaged polishing discs.
3. **Hold the polisher tightly at start-up.** Failure to do so may cause an injury due to high impact at initial start up.
4. **Stop using the polisher immediately when noticing any malfunctions or any suspicious abnormal noises.** Turn the power switch OFF and contact your dealer or Alpha Professional Tools® for repair.
5. **Handle the polisher with care.** If you accidentally drop the polisher, do not use it until checking that it is not cracked, deformed, or damaged in any way.
6. **Do not pour water or any liquids onto or inside the polisher.** It may cause electric shocks.
7. **Do not hold the polisher in a vice.**
8. **Do not touch any rotating parts.** Never touch the polishing disc of the polisher during operation with your hands.
9. **Do not leave the disc while spinning on the bench, floor or surface of your workpiece.** It may cause an accident or injury.
10. **Attach the backer pad and polishing disc correctly by following the procedure in this instruction manual.** Attaching the polishing discs incorrectly may cause an accident.
11. **Observe any suspicious abnormal noises when a polishing disc is attached for the first time and polisher is turned ON.** It may cause bodily injury if the polishing disc flies off.
12. **Do not touch the polishing disc while spinning.** The polishing disc spins very fast and you may hurt yourself.
13. **Be careful of your surroundings when working in high places.** When working in high places, make sure there are no people below. Do not strap the power supply cord on anything or drop the polisher or any materials, otherwise, It may cause an accident.

►LAWS AND REGULATIONS OF NOISE LEVELS

Please observe local laws and regulations regarding noise level in order to avoid disturbing surrounding areas. Install a soundproof wall if required to comply with the local laws and regulations.

VSP-320 OVERVIEW

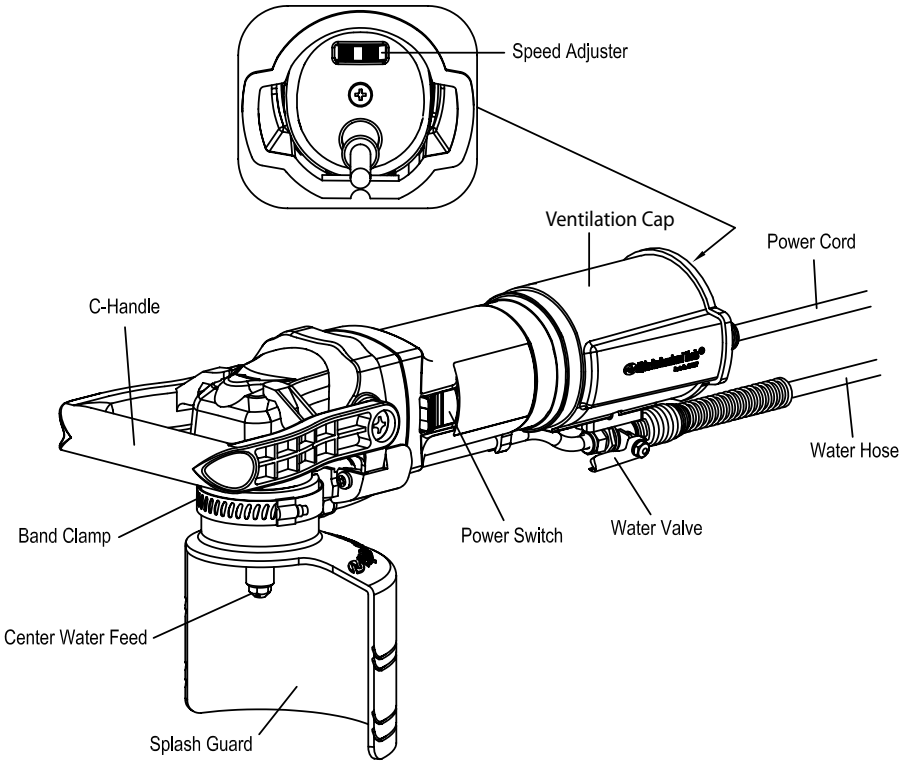

► **SPECIFICATIONS:**

Working Power Supply.....	Single-phase AC, 50/60Hz
Voltage.....	120V
Plug Type.....	A (120V)
Amperage.....	7A
Wattage.....	800W
Motor.....	Single-phase
No-Load.....	700~2500 RPM
Polishing Disc Size.....	4"
Cord.....	15' Single-phase Cable
Weight.....	7.3 lbs

Machine, Cord, GFCI, Water-line, Splash Guard

ACCESSORIES

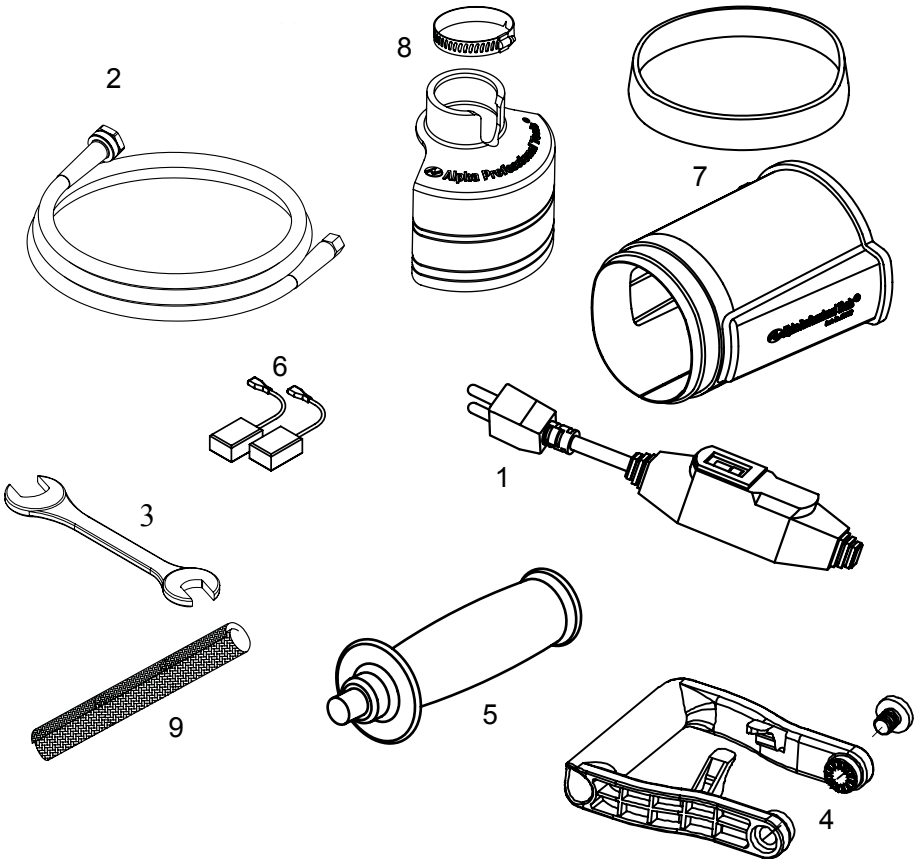

► COMPONENTS

1. Ground Fault Circuit Interrupter *	1 pc
2. Flexible Hose w/ Garden Hose Adapter *	1 pc
3. Wrench.....	1 pc
4. C-Handle w/ Mounting Screws *	1 pc
5. Side Handle (Reversible).....	1 pc
6. Extra Carbon Brush Set.....	1 pc
7. Ventilation Cap w/ Rubber Band *	1 pc
8. Splash Guard w/ Clamp	1 pc
9. EasyOn-EasyOff Sleeve *	1 pc

* Factory Attached

VSP-320 VARIABLE SPEED WET POLISHER OPERATION

⚠ DANGER!

Always be sure that the tool is switched off and unplugged before adjusting or checking function on tool.

► **MAIN CONNECTION**

Connect only to single-phase AC current supply and only to the main voltage specified on the rating plate.

► **SWITCHING ON AND OFF**

⚠ DANGER!

Before plugging in the tool, always check the working voltage. Be sure that the voltage specified is on the name plate. Before plugging in the tool, always check to see that the slide switch actuates properly and returns to the "OFF" position when the rear of the slide switch is depressed.

Switching on:

Switch can be locked in "ON" position for ease of operator comfort during extended use. Apply caution when locking tool in "ON" position and maintain firm grasp on tool. Push power switch to the forward position until it locks into position as shown in Figure 3.

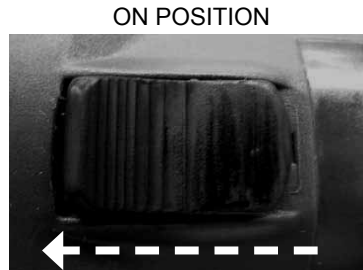

Figure-3

Switching off:

Push down on power switch to release to the rear position as shown in Figure 4.

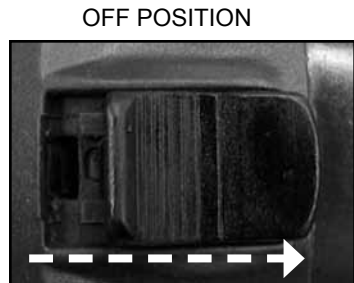

Figure-4

► **GROUND FAULT CIRCUIT INTERRUPTER (GFCI)**

A Ground Fault Circuit Interrupter is built in-line with the power supply cord to protect the operator from electric shock.

1. GFCI Information.

Alpha® Variable Speed Wet Polisher is provided with an in-line GFCI as a standard accessory for your safety and to prevent possible electric shocks. It is strongly advised to test the GFCI on a regular basis.

 **DANGER!**

Never attach a damaged extension cord to the polisher.

NOTE: Use the appropriate extension cord, see table on page 7.

 **CAUTION!**

When the GFCI trips, this could be the result of water entering the polisher housing.

Turn OFF the power switch, disconnect polisher from power supply and blow dry air inside the motor cover through the air vents.

Re-connect power supply and press the GFCI reset button. The polisher is ready to start working once the reset button is pressed down.

 **DANGER!**

Always check that the GFCI unit is working correctly (reset, test, and reset) before using this tool. Do not use the tool if the GFCI is not working correctly. Do not bypass the GFCI if this condition occurs, a real shock hazard may exist.

 **WARNING!**

If the GFCI fails to trip when the test button is pressed, or fails to reset, the device is defective and should be replaced.

 **CAUTION!**

The GFCI is a safety device, do not use as an on/off switch.

The GFCI on the tool will not protect you if you cut into another current carrying conductor.

Do not use where water may enter GFCI case.

► **TESTING IN-LINE GFCI UNIT** (Before Each Use Of The Polisher)

- Connect polisher to a single phase AC power supply.
- Verify that the indicator lens shows red (indicating output voltage).
- Press the test button to verify that the red in the indicator lens disappears.
- Press the reset button to verify the red indicator is visible.
- The GFCI is now ready for use.

⚠ WARNING!

DO NOT USE IF ABOVE TEST FAILS!

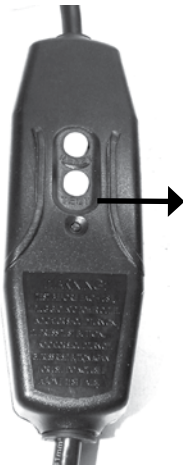

Figure-5

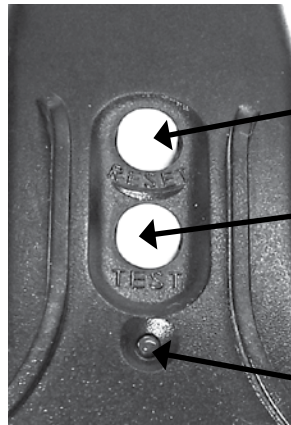

Figure-6

RESET BUTTON

TEST BUTTON

Indicator viewing lens.

RED lens shows power to polisher.

CLEAR lens shows no power to polisher.

► **VARIABLE SPEED ADJUSTMENT**

This polisher is equipped with a Variable Speed control that will allow the spindle speed to be adjusted from 700 RPM to 2500 RPM. Speed adjustment is controlled by rotation of the wheel as shown in the Figure 7.

NOTE- Wheel numbers are for reference point of motor speed (#1 is 700 RPM and #6 is 2500 RPM).

Adjust the RPM of the tool to match the recommended RPM of the product being used.

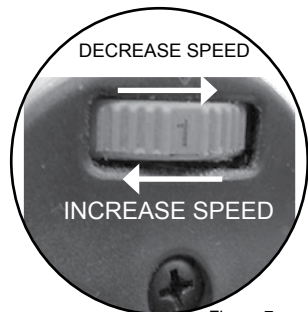

Figure-7

► **SPEED POT FEEDBACK SENSOR**

This polisher is equipped with a Closed Loop Feedback sensor that is attached to the speed pot. When a load is applied to the tool, the sensor will re-adjust the RPM to maintain a constant speed.

► **WATER CONTROL VALVE**

⚠ CAUTION!

Adjust the water flow to wet the stone and remove waste, excessive spray and mist will get inside the tool and cause premature failure of the tool and/or cause the GFCI to trip.

This polisher is equipped with a center water-feed system. Water flow to the spindle shower bolt can be controlled by throttling the valve stem as seen in Figure 8, Figure 9 and Figure 10.

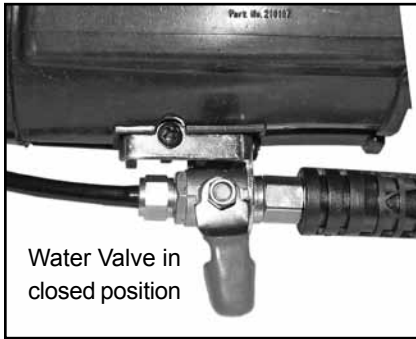

Figure-8

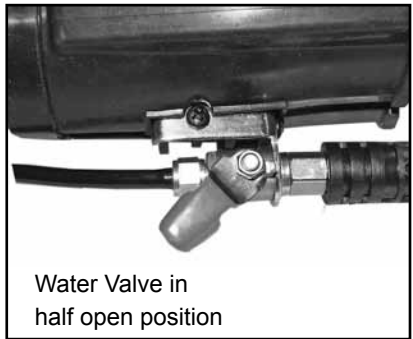

Figure-9

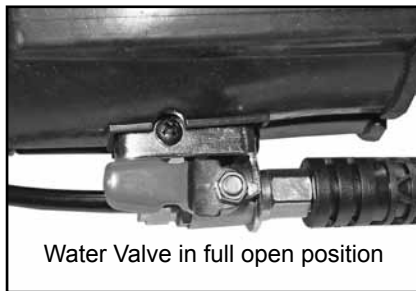

Figure-10

► **SIDE HANDLE INSTALLATION**

⚠ CAUTION!

During the use of Alpha® Core Bits and Profilers, use of the center handle is recommended. The center handle will allow the operator to have better control and ease of operation during these applications.

To switch from center handle to side handle, follow the steps below:

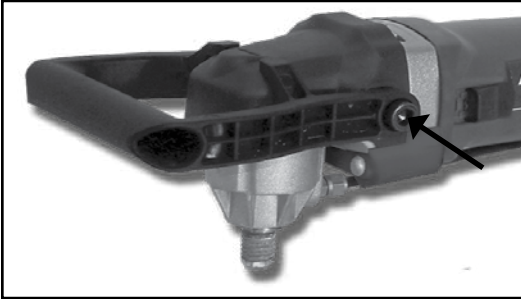

Figure-12

Remove both side screws from center handle.

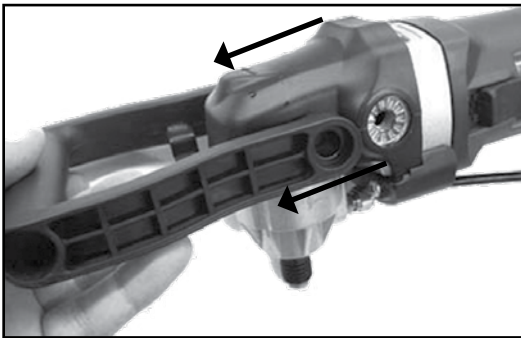

Figure-13

Pull handle forward and clear of polisher.



Figure-14

Thread the side handle into either the left or right side of the polisher, then thread one screw into the opposite side of the handle.

► **CUSTOMIZING THE SPLASH GUARD**

The splash guard can be cut to different heights according to the application to be performed.

Cutting: Using a pair of scissors or other cutting instruments, choose the desired height according to the application to be performed and cut along the grooved cut lines, as shown in Figure-15.

RECOMMENDED HEIGHTS:

Profiling: *When using Alpha® Profilers the splash guard can be used at its full height.*

Polishing: *When polishing, you may cut the splash guard at one of the grooved lines for easier access to the workpiece.*

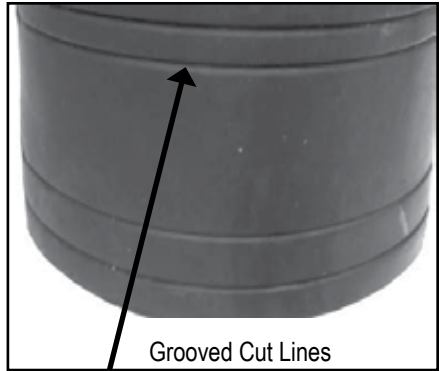

Figure-15

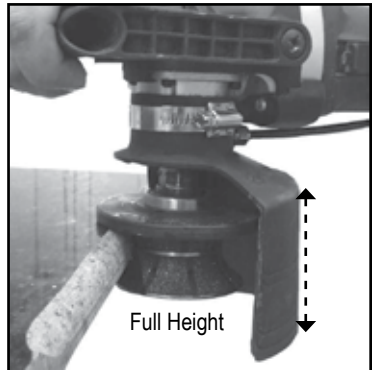

Figure-16

Splash Guard cut to accommodate polishing application

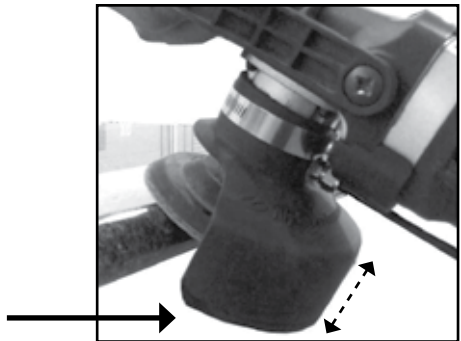

Figure-17

► **SPLASH GUARD INSTALLATION**

⚠ CAUTION!

The splash guard should be used to prevent the water and dust from going inside the tool. Failure to do so can shorten the life of your tool and void the warranty.

1. Install the rubber splash guard into the tool so that the lip on the splash guard fits into the groove on the tool and the cutout is around the water fitting.

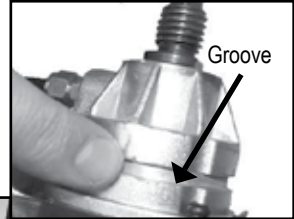

Figure-18

2. Open the band clamp completely and wrap around the splash guard under the water fitting.



Figure-19

3. Tighten the clamp until snug.

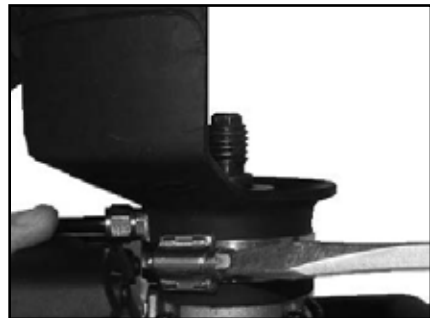

Figure-20

► PROFILER AND OTHER APPROVED SPINDLE ATTACHMENTS

⚠ CAUTION!

Do not leave threaded accessories on the spindle of the tool for extended periods of time, as this may result in making it difficult to remove these accessories.

The VSP-320 polisher has a 5/8"-11 center water-feed spindle thread.

To attach a profiler wheel or other approved spindle attachments, follow the steps below:

Screw the attachment onto the spindle by hand.



Figure-21

Tighten with supplied wrench.

NOTE : If attachment does not thread on freely, check threads on both surfaces for damage or dirt. Clean, repair or replace as needed to ensure a safe and tight connection to the polisher.



Figure-22

► WATER-FEED ATTACHMENT

Attach the polisher's water-line fitting to any garden hose connection.

OPERATION

⚠ WARNING!

To reduce the risk of electric shock, check the tool's water supply system to ensure there is no damage to the seals or hoses. A damaged water supply system may result in abnormal water flow to the tool which could be dangerous.

CAUTION!

Always wear safety goggles or a face shield during operation. Never switch on the tool when it is in contact with the workpiece, it may cause an injury to operator. Never run the tool without properly installed accessories.

Make sure that the water valve is closed. Connect the garden hose adapter to the water source. Make sure that water comes out when the water valve is opened. Hold the tool firmly. Turn the tool on and begin your application. Apply slight pressure only. Excessive pressure will result in poor performance and premature wear.

MAINTENANCE

CAUTION!

Always be sure that the tool is switched off and unplugged before attempting to perform inspection or maintenance.

► **DAILY**

1. Before daily start-up inspect tool, power cord, GFCI, and backer pad or other spindle attachments.
2. If damage has occurred, repair affected areas before use.
3. Connect the tool to the correct power source and test the Ground Fault Circuit Interrupter (GFCI) before using the tool. Push the RESET button and confirm that the red light is on, push the TEST button and confirm that the red run light is off and push the RESET button to use the tool.
4. Turn the unit on and run in a no-load condition to ensure that backer pad or other spindle attachment is balanced.
5. After daily use of the tool, clean and blow off the exterior of tool and around the rear air intake vents to remove any standing water or dust.
6. **BLOW AIR THROUGH VENT** - If dust or dirt settles inside the motor, it may cause the polisher to malfunction. After daily use of the tool, run the motor in a no-load mode and blow dry air through the vents of motor body. Make sure to wear safety protection when blowing air through tool as shown in Figure 23. Failure to do this will shorten the life of your tool, and could void your warranty.



Figure-23

► **PERIODIC**

⚠ WARNING!

Preventive maintenance preformed by unauthorized personnel may result in misplacing of internal wires and/or components which voids the warranty and could cause serious hazards. We recommend that tool service and repairs not covered in the manual be preformed by an Alpha® Repair Center.

Periodic maintenance is done to check the tool and to minimize down time. These checks are done based on hours of operation and operating conditions. Operating condition can vary depending on the work surface and job being preformed. If the tool is not used for a long period of time the carbon brushes should be checked and the commutator cleaned, before putting the tool back into operation.

► **BEARINGS AND GEARS**

To minimize your tool's down time and expensive tool repairs, it is recommended to send the tool back to an Alpha® Repair Center after about 300 to 400 hours of operation or every second carbon brush set change. The bearings should be replaced and the gears should be checked. If your tool starts to sound differently, this could be an indication of a worn bearing; continuing to use the tool in this condition could result in over heating or motor failure.

► **CARBON BRUSH REPLACEMENT**

Carbon brushes wear out over time, based on the polisher usage. If a carbon brush is worn out, it may cause the motor to malfunction or fail to run. Whenever the length of the carbon brush reaches the wear limit, replace with a new set.

NOTE - To maintain even wear, both brushes should be replaced at the same time. The carbon brushes in this polisher are located underneath the Rear Cover (Part # 210053) as shown in Figure 24.

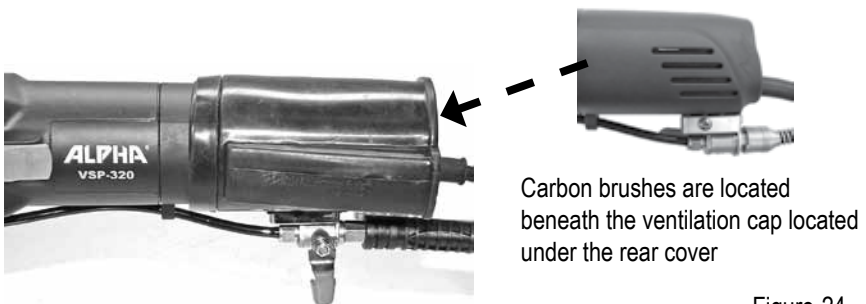

Figure-24

► **REAR COVER REMOVAL**

1. Gently pull water tube away from holder.

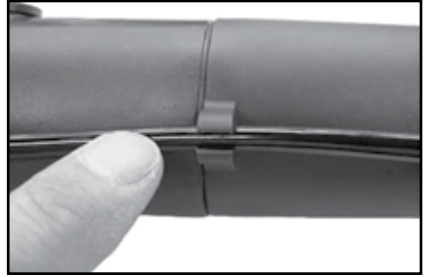

Figure-25

2. Release the tube from the holder.

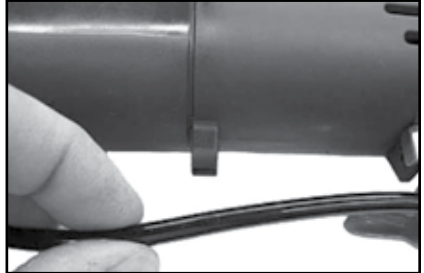

Figure-26

3. Unwrap 3 inches of the EasyOn EasyOff sleeve.



Figure-27

4. Remove the 2 screws from the valve bracket.

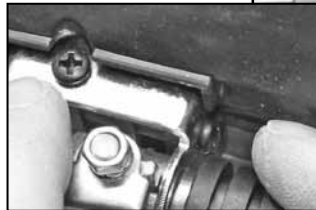

Figure-28

5. Pull the valve assembly away from mount.

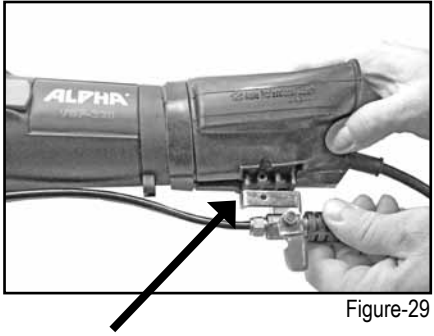

Figure-29

6. Remove the rear case screw.

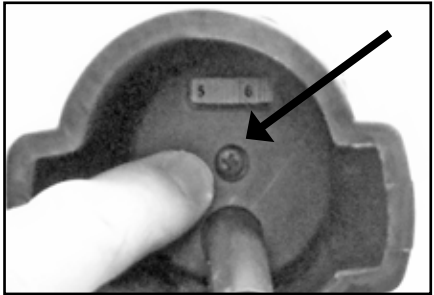

Figure-30

7. Hold polisher with one hand and pull the rear case straight back with the other hand.

NOTE: Do not twist case in a side to side motion when pulling back.



Figure-31

8. Pull back the rear case until the carbon brush assembly is exposed.

NOTE: Do not pull rear case further back from this point.



Figure-32

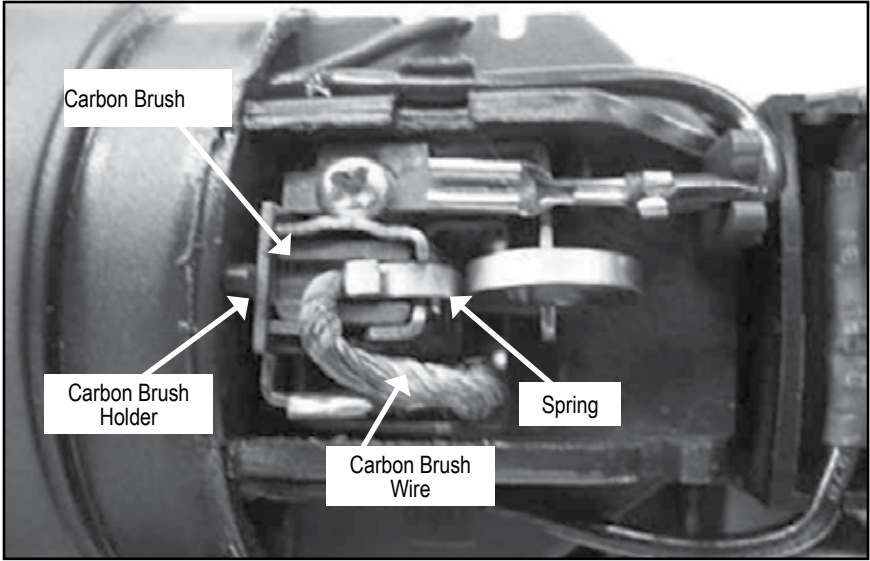

Figure-33

9. Lift the spring from the carbon brush and place on the side of the brush holder, as shown in Figure 34.
10. Remove the carbon brush wire quick-disconnect terminal from the terminal post and then remove the carbon brush, as shown in Figures 35 & 36.



Figure-34

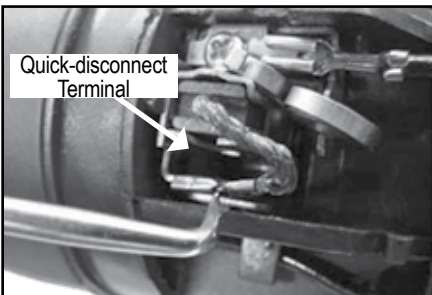

Figure-35

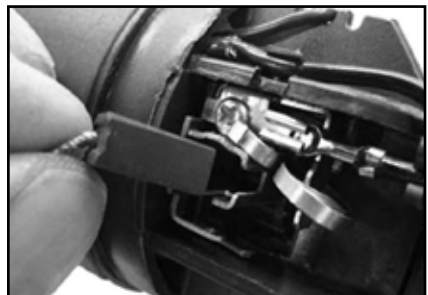

Figure-36

11. You can also remove the carbon brush by removing the screw and pulling the holder out with a pair of needle nose pliers, as shown in Figure 37.
12. With the carbon brush holder removed, you can check and clean the armature commutator. The commutator is the contact points that the carbon brushes ride on when the motor is running.

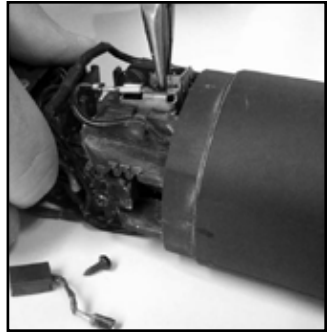

Figure-37

NOTE: Each polisher has 2 carbon brushes located on opposite sides of each other. After the replacement of the two brushes, assemble the polisher by reversing disassembly procedure.

13. Check the carbon brush for wear. Replace if worn down to a 1/4" .

Old Carbon Brush worn down to a quarter of an inch (1/4").

The Carbon Brushes may become stuck in the holder from a build-up of stone dust causing the motor to sputter and stop running.

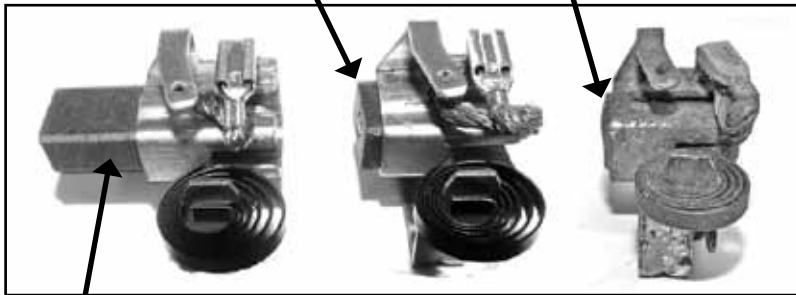

New Carbon Brush

Figure-38

14. Blow dust off of the spring and check for proper tension.
15. Remove the old carbon brush and quick disconnect from the carbon brush holder terminal. If the inside of the holder is filled with dust, clean before installing the new carbon brush. Upon installation of the new carbon brush, make sure the twisted wire is in the slot and behind the wire terminals on holder as in the photo above.

16. The commutator should be clean and shiny; if it is dull and black, you can clean it with a commutator cleaning stone (Alpha® Part No. AT006).

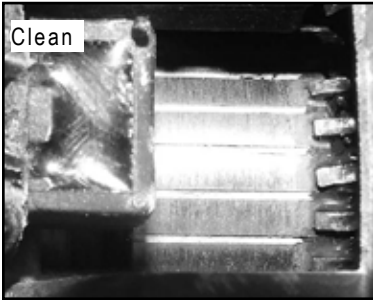

Figure-39

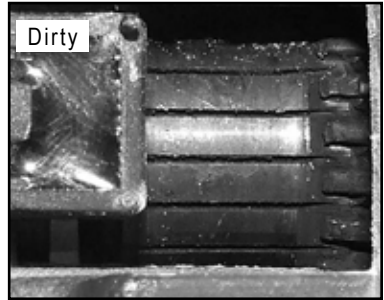

Figure-40

17. To clean the commutator, press the commutator cleaning stone against the commutator and rotate the armature by turning the spindle shaft by hand. Continue for a minute or until commutator is clean and shiny.

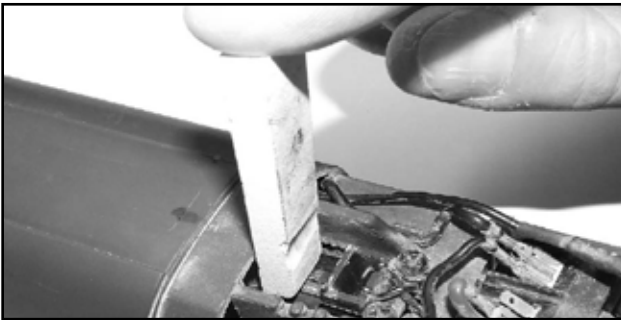
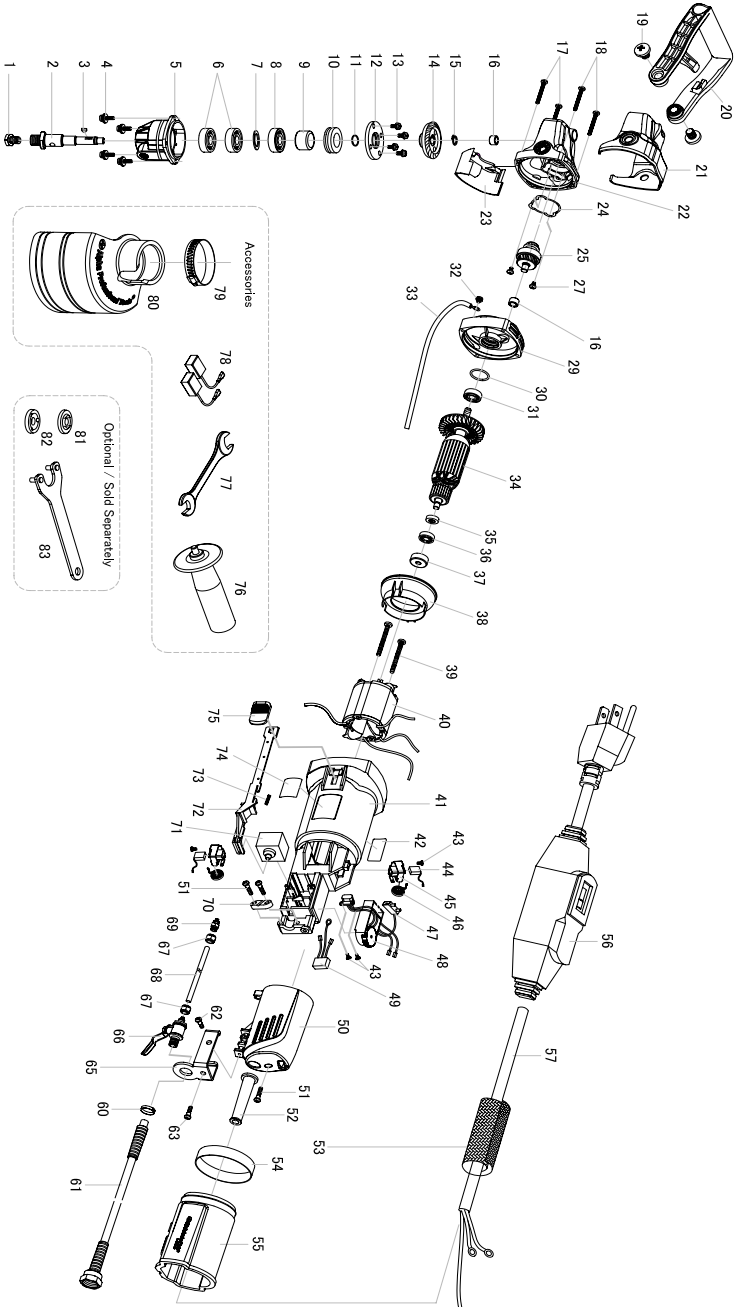

Figure-41

18. Reconnect the power wire, ensuring that the wire path is correct. Reinstall the carbon brush holder into the slot on motor housing and slide in until the tab for the screw hits the stop. Install the screw using light pressure to prevent it from stripping.
19. After both carbon brushes have been replaced you can reassemble the rear cover. Make sure the power wires are in the tool to prevent pinching of the wires.

ALPHA® VSP-320 SCHEMATIC



ALPHA® VSP-320 PARTS LIST

DRAWING NO.	PART NO.	DESCRIPTION	QUANTITY
1	210004	Shower Bolt	1
2	210109	Output Shaft (5/8"-11 UNC)	1
3	210006	Key (3x10)	1
4	210111	Combination Screw M4x14	4
5	210090	Gear Case Cover	1
6	210008	Oil lip seal B16x28x7D	2
7	210009	Bearing Washer	1
8	210010	Ball Bearing 6201	1
9	210011	Gear Washer	1
10	210012	Thrust Bearing 15x28x6	1
11	210112	O-Ring (15x2.65)	1
12	210013	Bearing Clamp	1
13	210113	Combination Screw M5x16	4
14	210114	Gear	1
15	210018	C-clip for shaft 10	1
16	210019	Oil-impregnated Bearing 8x12x8	2
17	210021	Self-tapping Screw 4.2x45	2
18	210115	Self-tapping Screw 4.2x40	2
19	210023	Screw M10x20	2
20	210024	C-handle	1
21	210134	Case Plastic Cover	1
22	210027	Gear Case	1
23	210076	Dash Panel	1
24	210116	Sealing Ring	1
25	210117	Pinion Gear Sub Assembly	1
27	210033	Screw M4x8	2
29	210118	Bearing Retainer	1
30	210035	O-Ring (21.2x1.8)	1
31	210036	Ball Bearing 608	1
32	210119	Combination Screw M4x8	1
33	210120	Wire Lead (Circular lugs 4#)	1
34	210121	Armature 120V	1
35	210095	Magnetic Ring	1
36	210038	Ball Bearing 607	1
37	210039	Rubber Bearing Seat	1
38	210106	Wind Shield	1
39	210041	Self-tapping Screw 4.2x70	2
40	210122	Field Coil 120V	1
41	210091	Field Coil Case	1

ALPHA® VSP-320 PARTS LIST

DRAWING NO.	PART NO.	DESCRIPTION	QUANTITY
42	210123	Data Label	1
43	210049	SST Self-tapping Screw 2.9×8	4
44	210048	Carbon Brush 120V Set	1
45	210046	Carbon Brush Holder	2
46	210047	Coil Spring	2
47	210094	Terminal Block	1
48	210135	Speed pot w/Feed-back sensor 120V	1
50	210053	Rear Cover	1
51	210054	Self-tapping Screw 4.2×14	3
52	210055	Cord Jacket	1
53	210124	Memory Wrap (1m)	1
54	210108	Rubber Band	1
55	210107	Ventilation Cap	1
56	210125	GFCI 120V	1
57	210126	Power Supply Cord	1
60	210128	Lock Washer 3/8"	1
61	210129	Water Hose Assembly (15ft./5m)	1
63	210078	Self-tapping Screw 4.2×10	2
65	210063	Water Valve Bracket	1
66	210064	Water Valve Assembly	1
67	210132	Nut M10	2
68	210065	Water Hose 6mm ODx8in (20cm)	1
69	210067	Outlet Tap	1
70	210066	Cord Clamp	1
71	210068	Switch	1
72	210070	Switch Push Lever	1
73	210069	Back Moving Spring	1
74	210133	Brand Label	1
75	210071	Switch Push Button	1
76	210074	Side Handle	1
77	210110	Open End Wrench (19mm)	1
78	210048	Spare Set of Carbon Brushes	1
79	210088	Band Clamp 40-63	1
80	210089	Splash Guard	1
OPTIONAL/SOLD SEPARATELY			
81	110301	Flange (5/8"-11) for Variable Drive	1
82	210301	Locknut (5/8"-11) for Variable Drive	1
83	210105	Pin Wrench	1

► ACCESSORIES AND FACTORY SERVICE

All the accessories can be purchased at a local distributor in your area. For more information concerning Alpha® Variable Speed Polisher (VSP-320) and factory service, please contact the Alpha® distribution centers listed below.

COMPANY HEADQUARTERS & REPAIR CENTER:

Alpha Professional Tools®

103 Bauer Drive

Oakland, NJ 07436

Hours of Operation:

8:30 a.m. – 5:00 p.m. EST

Telephone Number:

201-337-3343

Toll-Free Number:

800-648-7229

CANADIAN REPAIR CENTER:

Edgewood Sales & Marketing

10 Simon Court

Waterford, ON N0E 1Y0

Telephone Number:

519-896-4992

► WARRANTY

Limited Warranty of Alpha® Variable Speed Polisher (VSP-320) for USA and Canada ONLY!

Alpha Professional Tools® warrants this product against defects in material and workmanship for a period of one year from the date of original retail purchase (proof of purchase required). If Alpha Professional Tools® receives notice of such defects during the warranty period, our obligation assumed under this warranty is limited to the repair or replacement of parts, without charge. This warranty does not apply to Alpha® accessories. Returns within the warranty period should be sent in freight prepaid to an Authorized Warranty Service Centers.

The warranty does not apply in situations where:

- The tool has been misused, abused or improperly maintained
- Alterations or repairs were made by others
- Repairs due to normal wear and tear

Some States do not allow limitations on how long an implied warranty lasts or the exclusion or limitation of incidental or consequential damages, so the above limitation may not apply. This warranty gives you specific legal rights and you may also have other rights which vary from state to state.

For Warranty Claims: Send complete tool with all your information and details of the problem to an Authorized Warranty Repair Center, transportation prepaid. Do not send tool accessories.

NOTE: *Any tools purchased through an unauthorized distributor are not covered under warranty.*

PRODUCT REGISTRATION CARD

Model No. **VSP-320** Serial No. _____

Company Name: _____

Name: _____

Address: _____

City: _____ State: _____ Zip: _____

Email: _____

Telephone: _____

Purchase Date: _____

Dealer's Name: _____

Note: Serial & Model Number must be included for proper registration.



Alpha Professional Tools®

(800) 648-7229



Register online at:
www.alpha-tools.com/productregistration.aspx

Mail or Fax to:
Alpha Professional Tools®
103 Bauer Drive, Oakland, NJ 07436
Fax: 800-286-0114

Photocopy of product registration form will be accepted.



103 Bauer Drive, Oakland, NJ 07436 • 800-648-7229 • Fax: 800-286-0114
www.alpha-tools.com

Copyright © 2016 Alpha Professional Tools. All rights reserved.