

► WBC5KIT SCHEMATICS

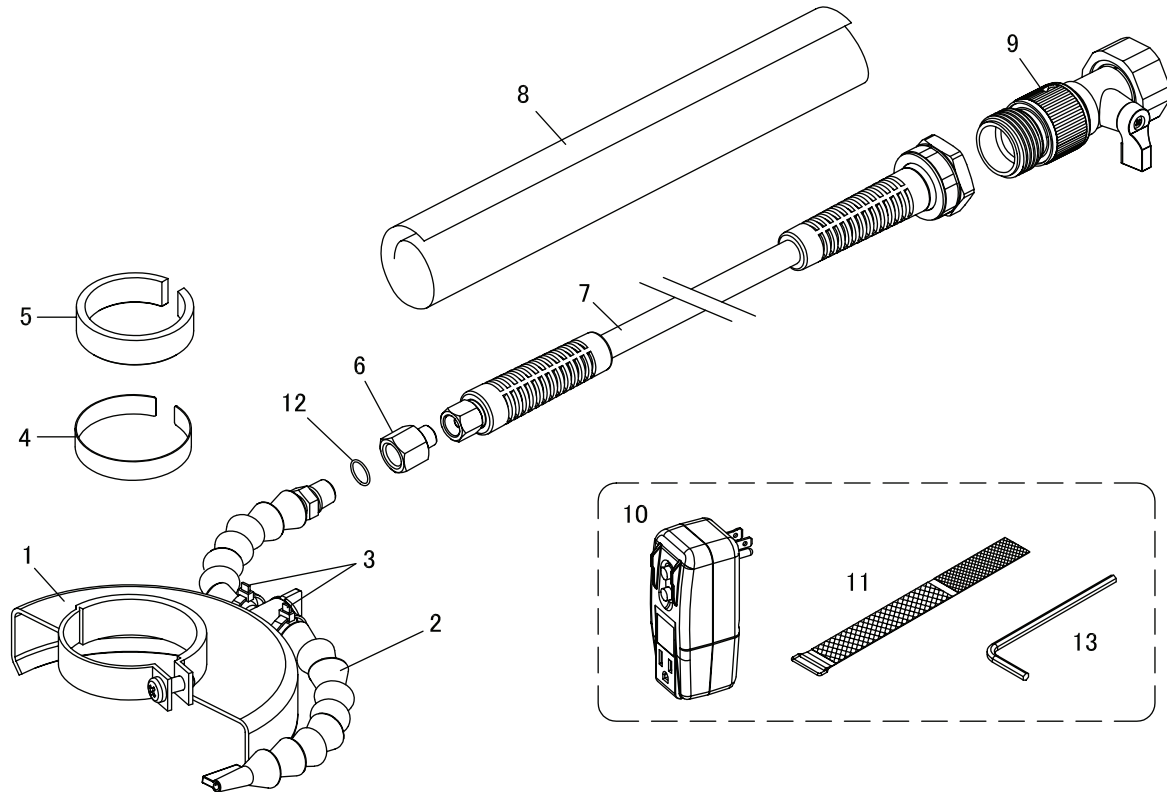

► WBC5KIT PARTS LIST

ITEM NO.	PART NO.	DESCRIPTION	QUANTITY
1	140007	5" Safety Guard	1
2	140004	Loc-Line Assembly	1
3	PDH-CABLETIES	Plastic Tie	2
4	133778	Stainless Steel Collar	1
5	133779	Plastic Collar	1
6	133780	Adapter (1/4 NPT>>>M10*P1.0)	1
7	210129	Water Hose Assembly (15ft./4.5m)	1
8	210124	Memory Wrap (3ft./1m)	1
9	658-113	Water Quick Coupler w/Shut-Off Valve	1
10	GFCI-1	GFCI Plug (120V)	1
11	140003	Hook & Loop Strap (1-1/2" x 12")	1
12	133805	Washer	1
13	658-143	Hex. Wrench 6mm	1